

CRIME / INCIDENT REPORT

VENTURA COUNTY SHERIFF'S DEPARTMENT

AGENCY IDENTIFIER CA0560000

1 CONNECTING REPORT NUMBERS		2 R.D.	3 BEAT	4 RB NUMBER
		9072	9601	06-30492
5 <input type="checkbox"/> CRIME <input type="checkbox"/> INCIDENT <input type="checkbox"/> SUPPLEMENTAL		8 <input type="checkbox"/> DOMESTIC <input type="checkbox"/> CHILD ABUSE <input type="checkbox"/> HATE		
<input type="checkbox"/> CASE CLEARED <input checked="" type="checkbox"/> OFFICER-INVOLVED SHOOTING		<input type="checkbox"/> GANG <input type="checkbox"/> ELDERLY ABUSE <input type="checkbox"/>		
7 CODE SECTION / DESCRIPTION (INCIDENT) 196 PC / HOMICIDE		9 CLASS. <input type="checkbox"/> Misd. <input type="checkbox"/> Fel.	9 CODE SECTION / DESCRIPTION (<input type="checkbox"/> Reclassify To)	
11 CODE SECTION / DESCRIPTION (INCIDENT)		12 CLASS. <input type="checkbox"/> Misd. <input type="checkbox"/> Fel.	13 CODE SECTION / DESCRIPTION (<input type="checkbox"/> Reclassify To)	
15 OCCURRED FROM	MO. DAY YR. TIME	16 DOW	17 OCCURRED TO	MO. DAY YR. TIME
	11 14 06 1820	TUE		
CITY		STATE	ZIP	
THOUSAND OAKS, CA				
20 CODE		V-VICTIM	W-WITNESS	R-REPORTING PARTY
22 NAME (Last, First, Middle, Gen.) / FIRM NAME		AKA / Moniker		
V CANLEY, ADRIAN DOYLE				
44 NAME (Last, First, Middle, Gen.) / FIRM NAME	AKA / Moniker	RACE	SEX	HT
63 RESIDENCE ADDRESS / (<input type="checkbox"/> Same as Box #)		CITY	STATE	ZIP
65 BUSINESS / SCHOOL NAME		ADDRESS / (<input type="checkbox"/> Same as Box #)	CITY	STATE
67 OCCUPATION (<input type="checkbox"/> STUDENT)	68 DAYS OFF	69 WORK HRS	60 INTERPRETER	61 OPERATOR'S LIC. NO. / STATE
62 VEH. LIC. NO. / STATE	63 VEH. COLOR / YEAR / MAKE / MODEL / BODY STYLE	64 OTHER CHARACTERISTICS / VIN NO.		
65 ARSON	66 BURGLARY	68 THEFT	70 FORCE / WEAPON	72 SPECIAL INTEREST
<input type="checkbox"/> Single Fam. Resd.	<input type="checkbox"/> Residential	<input type="checkbox"/> Auto Parts	<input type="checkbox"/> No Force	(Copy to Agency/Unit)
<input type="checkbox"/> Inhabited	<input type="checkbox"/> Vehicle	<input type="checkbox"/> Bicycle	<input type="checkbox"/> No Weapon	<input type="checkbox"/> Domestic Violence
<input type="checkbox"/> Uninhabited	<input type="checkbox"/> Commercial	<input type="checkbox"/> From Bldg.	<input type="checkbox"/> Verbal Only	<input type="checkbox"/> Sex Crime
<input type="checkbox"/> Storage	<input type="checkbox"/> Other	<input type="checkbox"/> Coin Machine	<input type="checkbox"/> Attempt Only	<input type="checkbox"/> Child Abuse <input type="checkbox"/> PSSA
<input type="checkbox"/> Industrial		<input type="checkbox"/> From Person	<input type="checkbox"/> Great Bodily Injury	<input type="checkbox"/> Gang Related
<input type="checkbox"/> Commercial		<input type="checkbox"/> From Vehicle	<input checked="" type="checkbox"/> Firearm	<input type="checkbox"/> Hate Crime
<input type="checkbox"/> Other Structure	67 ROBBERY	<input type="checkbox"/> Purse Snatch	<input type="checkbox"/> Knife	<input type="checkbox"/> Agricultural
<input type="checkbox"/> Public Place	<input type="checkbox"/> Bank	<input type="checkbox"/> Shoplift	<input type="checkbox"/> Hands/Fists/Feet	<input type="checkbox"/> Probation <input type="checkbox"/> Parole
<input type="checkbox"/> Vehicle	<input type="checkbox"/> Chain Store	<input type="checkbox"/> Other	<input type="checkbox"/> Other	<input type="checkbox"/> Other
<input type="checkbox"/> Unlawful Fire	<input type="checkbox"/> Commercial			
<input type="checkbox"/> Forest	<input type="checkbox"/> Gas Station			
<input type="checkbox"/> Injury Occurred	<input type="checkbox"/> Highway	69 VALUE / DOLLAR LOSS	71 DOMESTIC VIOLENCE / SEX / HATE CRIMES	
<input type="checkbox"/> Other	<input type="checkbox"/> Residence	\$	<input type="checkbox"/> D.V. and/or S. A. Pamphlet given to: <input type="checkbox"/> Victim <input type="checkbox"/> P-1 <input type="checkbox"/> P-2	
	<input type="checkbox"/> Other	VALUE / DAMAGE LOSS	<input type="checkbox"/> Pursuant to Sec. 6254 G.C., victim of D.V., Sex or Hate Crime requests their name be withheld from the public. <input type="checkbox"/> YES <input type="checkbox"/> NO	
		\$		
73 DATE AND TIME REPORTED	74 DATE / TIME OF REPORT	75 REPORTING OFFICER / ID NO. / DM / UNIT	76 APPROVED BY / ID NO.	
11/14/06 1820	12/06/06 1400	W AYUB / 3318 / SPEC. SVC. / MC	J. [Signature] #1917 SET	
77 CHECKS TO: <input type="checkbox"/> DOMESTIC VIOLENCE <input type="checkbox"/> GANG / NARC. <input type="checkbox"/> STARS <input type="checkbox"/> VIOLENCE <input type="checkbox"/> D.S.V. <input type="checkbox"/> COURT <input type="checkbox"/> OTHER				

CRIME / INCIDENT REPORT

VENTURA COUNTY SHERIFF'S DEPARTMENT
AGENCY IDENTIFIER CA0560000

1 CONNECTING REPORT NUMBERS				2 R.D. 9072		3 BEAT 9G01		4 RB NUMBER 2006-30492										
5 <input checked="" type="checkbox"/> CRIME <input type="checkbox"/> INCIDENT <input type="checkbox"/> SUPPLEMENTAL <input type="checkbox"/> CASE CLEARED <input type="checkbox"/> _____					6 <input type="checkbox"/> DOMESTIC <input type="checkbox"/> CHILD ABUSE <input type="checkbox"/> HATE <input type="checkbox"/> GANG <input type="checkbox"/> ELDERLY ABUSE <input type="checkbox"/> _____													
7 CODE SECTION / DESCRIPTION (INCIDENT) PC 245(c) / ADW on a Peace Officer			8 CLASS. <input type="checkbox"/> Misd. <input checked="" type="checkbox"/> Fel.		9 CODE SECTION / DESCRIPTION (<input type="checkbox"/> Reclassify To)			10 CLASS. <input type="checkbox"/> Misd. <input type="checkbox"/> Fel.										
11 CODE SECTION / DESCRIPTION (INCIDENT)			12 CLASS. <input type="checkbox"/> Mi3d. <input type="checkbox"/> Fel.		13 CODE SECTION / DESCRIPTION (0 Reclassify To)			14 CLASS. <input type="checkbox"/> Misd. <input type="checkbox"/> Fel.										
15 OCCURRED FROM Mo. DAY YR. TIME 11 14 06 1841			16 DOW Tuesday		17 OCCURRED TO Mo. DAY YR. TIME			1a DOW										
19 LOCATION OF OFFENSE / INCIDENT ADDRESS CITY STATE ZIP 2222 Los Feliz Drive Thousand Oaks Ca. 91360																		
20 CODE: V-VICTIM W-WITNESS R-REPORTING PARTY F-FINDER O-OWNER P-PARTY																		
CODE 21 V	22 NAME (Last, First, Middle, Gen.) / FIRM NAME Matthews, Shane			AKA / Moniker	RACE 23	SEX 24	25 HT	26 WT	27 HAIR	28 EYES	29 DOB	30 AGE						
31 RESIDENCE ADDRESS / (<input type="checkbox"/> Same as Box X _____) CITY STATE ZIP									32 RESIDENCE PHONE ()									
33 BUSINESS / SCHOOL NAME ADDRESS / (<input type="checkbox"/> Same as Box# _____) CITY STATE ZIP									34 BUSINESS PHONE (805) 494-8200									
35 OCCUPATION (<input type="checkbox"/> STUDENT) Senior Deputy Sheriff / Detective			36 DAYS OFF Vary		37 WORK HRS Vary		38 INTERPRETER		39 OPERATOR'S LIC. NO. / STATE									
40 VEH. LIC. NO. / STATE		41 VEH. COLOR / YEAR / MAKE / MODEL / BODY STYLE		42 OTHER CHARACTERISTICS / VIN NO.														
CODE 43	44 NAME (Last, First, Middle, Gen.) / FIRM NAME			AKA / Moniker	RACE 45	SEX 46	47 HT	4a WT	49 HAIR	50 EYES	51 DOB	52 AGE						
53 RESIDENCE ADDRESS / (<input type="checkbox"/> Same as Box 9 _____) CITY STATE ZIP									54 RESIDENCE PHONE ()									
55 BUSINESS / SCHOOL NAME ADDRESS / (<input type="checkbox"/> Same as Box# _____) CITY STATE ZIP									56 BUSINESS PHONE ()									
57 OCCUPATION (<input type="checkbox"/> STUDENT)			58 DAYS OFF		59 WORK HRS		60 INTERPRETER		61 OPERATOR'S LIC. NO. / STATE									
62 VEH. LIC. NO. / STATE		63 VEH. COLOR / YEAR / MAKE / MODEL / BODY STYLE		64 OTHER CHARACTERISTICS / VIN NO.														
65 ARSON <input type="checkbox"/> Single Fam. Resd. <input type="checkbox"/> Inhabited <input type="checkbox"/> Uninhabited <input type="checkbox"/> Storage <input type="checkbox"/> Industrial <input type="checkbox"/> Commercial <input type="checkbox"/> Other Structure <input type="checkbox"/> Public Place <input type="checkbox"/> Vehicle <input type="checkbox"/> Unlawful Fire <input type="checkbox"/> Forest <input type="checkbox"/> Injury Occurred <input type="checkbox"/> Other			66 BURGLARY <input type="checkbox"/> Residential <input type="checkbox"/> Vehicle <input type="checkbox"/> Commercial <input type="checkbox"/> Other			67 ROBBERY <input type="checkbox"/> Bank <input type="checkbox"/> Chain Store <input type="checkbox"/> Commercial <input type="checkbox"/> Gas Station <input type="checkbox"/> Highway <input type="checkbox"/> Residence <input type="checkbox"/> Other			68 THEFT <input type="checkbox"/> Auto Parts <input type="checkbox"/> Bicycle <input type="checkbox"/> From Bldg. <input type="checkbox"/> Coin Machine <input type="checkbox"/> From Person <input type="checkbox"/> From Vehicle <input type="checkbox"/> Purse Snatch <input type="checkbox"/> Shoplift <input type="checkbox"/> Other		69 VALUE / DOLLAR LOSS \$ _____ VALUE / DAMAGE LOSS \$ _____		70 FORCE / WEAPON <input type="checkbox"/> No Force <input type="checkbox"/> No Weapon <input type="checkbox"/> Verbal Only <input checked="" type="checkbox"/> Attempt Only <input type="checkbox"/> Great Bodily Injury <input type="checkbox"/> Firearm <input type="checkbox"/> Knife <input type="checkbox"/> Hands/Fists/Feet <input type="checkbox"/> Other vehicle		71 DOMESTIC VIOLENCE / SEX / HATE CRIMES <input type="checkbox"/> D.V. and/or S. A. Pamphlet given to: <input type="checkbox"/> victim <input type="checkbox"/> P-1 <input type="checkbox"/> P-2 <input type="checkbox"/> Pursuant to Sec. 6254 G.C., victim of D.V., Sex or Hate Crime requests their name be <u>withheld</u> from the public. <input type="checkbox"/> YES <input type="checkbox"/> NO		72 SPECIAL INTEREST (Copy to Agency/Unit) <input type="checkbox"/> Domestic Violence <input type="checkbox"/> Sex Crime <input type="checkbox"/> Child Abuse <input type="checkbox"/> PSSA <input type="checkbox"/> Gang Related <input type="checkbox"/> Hate Crime <input type="checkbox"/> Agricultural <input type="checkbox"/> Probation <input type="checkbox"/> Parole <input checked="" type="checkbox"/> Other Major Crimes	
73 DATE AND TIME REPORTED 11-14-2006 / 1841 hours			74 DATE / TIME OF REPORT 11-15-2006 / 0030 hours			75 REPORTING OFFICER / ID NO / DIV / UNIT M. Berg #1929 / ECPS - Thousand Oaks			76 APPROVED BY / ID NO. <i>J. Berg</i> / 20186									
77 COPIES TO <input checked="" type="checkbox"/> DEC / MC <input type="checkbox"/> NARC <input type="checkbox"/> GANG/SED <input type="checkbox"/> STATS <input type="checkbox"/> PRESS <input type="checkbox"/> DOJ <input type="checkbox"/> COURT <input type="checkbox"/> OTHER																		

1 RD 9072	2 BEAT 9G01	3 RB NUMBER 06-30492
--------------	----------------	-------------------------

4 CODE	5 ITEM	6 QTY.	7 ITEM NAME	8 BRAND / MAKE MANUFACTURER	9 MODEL NAME OR NUMBER	10 MISC. DESCRIPTION	11 IDENTIFICATION / SERIAL NUMBER	12 VALUE
--------	--------	--------	-------------	-----------------------------	------------------------	----------------------	-----------------------------------	----------

- Supplemental Case Cleared
 Gang Domestic Hate Child Abuse Elderly Abuse

Connecting Report Numbers:

Code Section / Description: Officer Involved Shooting

Reclassify To:

Code: P Name: Canley, Adrian

Incident Scene Report

On 11/14/06, at about 1835 hours, I received a telephone call from Captain Kelley, who requested that I respond to assist with the investigation of an officer-involved shooting at [REDACTED] Thousand Oaks. I responded to the incident scene from the Ventura Major Crimes' Office, and I arrived at the scene at about 1920 hours.

When I arrived on scene, I noted numerous emergency services resources already deployed, including numerous sheriff's personnel and Ventura County Fire Department personnel. I also noted that crime scene tape marked off an outer perimeter, and that an inner perimeter surrounding the incident scene had also been cordoned off with crime scene tape. There were no personnel inside the inner perimeter scene when I arrived.

I met with my partner, Detective Rob Davidson, who had arrived before me. Detective Davidson briefed me on the circumstances surrounding the shooting, and, in summary, told me the following. Senior Deputy Shane Matthews was working as a plain-clothes property crimes detective, and he went to the apartments at [REDACTED] to interview a witness in a grand theft investigation. During his interview with the witness, a man, who was later identified as Adrian Canley, approached Matthews and initiated a confrontation. As the confrontation unfolded, Canley got into a white Ford pickup and drove toward Matthews. Matthews then reportedly fired several shots from his service pistol at Canley, striking Canley at least once in the upper chest. Canley was administered first aid at the scene, and he was transported to the

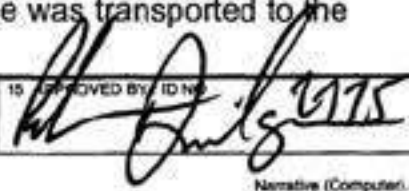
13 DATE / TIME OF REPORT 02/01/07/ 2:15 PM	14 REPORTING OFFICER / ID NO / DIV / UNIT Sgt. W. Ayub/#3318/Special Services	15 APPROVED BY / ID NO 
---	--	---

NARRATIVE REPORT VENTURA COUNTY SHERIFF'S DEPARTMENT

Page 2 of 6

Continuation

AGENCY IDENTIFIER CA0560000

1 RD 9072	2 BEAT 9G01	3 RB NUMBER 06-30492
--------------	----------------	-------------------------

4 CODE	5 ITEM	6 QTY.	7 ITEM NAME	8 BRAND / MAKE MANUFACTURER	9 MODEL NAME OR NUMBER	10 MISC. DESCRIPTION	11 IDENTIFICATION / SERIAL NUMBER	12 VALUE
--------	--------	--------	-------------	-----------------------------	------------------------	----------------------	-----------------------------------	----------

Los Robles Regional Medical Center where he died from his wounds. As we spoke, Detective Davidson pointed out various features inside the inner perimeter scene, including a white Ford F-150 pickup, several expended pistol cartridges, clothing, and first aid supplies.

I noted the property at [REDACTED] consists of (2) two-story apartment buildings, a community center building, and numerous covered carports with an open parking area. The property to the west of [REDACTED] which has an address of [REDACTED] [REDACTED] has a three story senior citizen complex that overlooks the parking area where this incident occurred. The property east of [REDACTED] is mostly undeveloped with some low-lying residential structures.

The complex at [REDACTED] is known as [REDACTED] and it is accessed off of [REDACTED]. As one enters the complex, there is a long asphalt driveway that extends approximately 350 feet toward the south end of the property. On the east side of the driveway, just past the property entrance, is a two-story apartment building containing apartments [REDACTED] and there are covered carports along the west side of the driveway. There is a community center building with an outdoor pool on the east side of the property, just south of the aforementioned apartment building.

In the center of the driveway, past the first apartment building and the community center building, is a large circular planter containing a tree. This planter and tree serve as a traffic round, and the driveway continues around and past the planter. There are two opposing sets of covered carports just south of the planter, and there is a U-shaped two-story apartment building just south of the covered carports. The U-shaped apartment building contains apartments [REDACTED]. To the east of the opposing carports is a small parking lot, which is where this incident unfolded.

The parking lot is paved with asphalt and it is accessed off of the traffic round (just east of the large circular planter with the tree). The access way into the parking lot is at the northwest corner of the parking lot. The parking lot is rectangular in shape and measures approximately 100 feet in length (north to south) and approximately 66 feet in width (east to west). The north side of the parking lot is enclosed with a concrete curb, planter, sidewalk, and the community center building. The east side of the parking lot is enclosed with a concrete

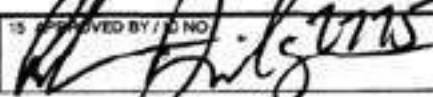
13 DATE / TIME OF REPORT 02/01/07/ 2:15 PM	14 REPORTING OFFICER / ID NO / DIV / UNIT Sgt. W. Ayub/#3318/Special Services	15 APPROVED BY / ID NO 
---	--	---

NARRATIVE REPORT VENTURA COUNTY SHERIFF'S DEPARTMENT

Page 3 of 6

Continuation

AGENCY IDENTIFIER CA0560000

1 RD 9072	2 BEAT 9G01	3 RB NUMBER 06-30492
--------------	----------------	-------------------------

4 CODE	5 ITEM	6 QTY.	7 ITEM NAME	8 BRAND / MAKE MANUFACTURER	9 MODEL NAME OR NUMBER	10 MISC. DESCRIPTION	11 IDENTIFICATION / SERIAL NUMBER	12 VALUE
--------	--------	--------	-------------	-----------------------------	------------------------	----------------------	-----------------------------------	----------

curb, planter, and a 6-foot cinder block wall, which is capped with wrought iron fencing. The south side of the parking lot is enclosed with a concrete curb, a grassy standoff, and the north exterior wall of apartments 108 and 208. The west side of the parking lot is enclosed with a cement curb, a grassy standoff, and the east wall of the covered carports. There are 9 parking stalls perpendicular to the west curb line and there are 11 parking stalls perpendicular to the east curb line. There is a raised cement planter on the north side of the parking stalls against the west curb line. That planter contained several thick rose bushes and a tree.

I examined the inner perimeter of the incident scene, which included the entire parking lot area described above. There were 14 vehicles parked within the parking area. All of the vehicles were within marked parking stalls with the exception of a marked black and white Thousand Oaks Police Ford Crown Victoria patrol vehicle (unit #3263) and a white Ford F-150 pickup truck, [REDACTED]. The patrol unit was parked facing in an easterly direction just inside the driveway entrance to the parking lot, and the white Ford F-150 was parked facing in a northerly direction against the north curb line of the parking area. The black and white patrol unit was parked partially behind and perpendicular to the Ford F-150. Also of note was Detective Matthews' unmarked police vehicle, which was a maroon colored Chevrolet Astro van, [REDACTED]. It was parked against the east curb line in the third stall south of the north curb line and, its right rear cargo door was standing open.

I examined each of the vehicles located within the incident scene and I saw no evidence that led me to believe any of the other vehicles within the parking area contained any evidence, sustained any damage, or were involved in this incident in any manner. For specific details of the other vehicles parked within the scene, refer to Senior Deputy Godfrey's supplemental report and/or the incident scene images.

As I walked around the perimeter of the incident scene, I saw a small notebook and a compact disc with a Sheriff's Department label lying on the grassy area on the west side of the parking area between the sidewalk and the east wall of the carports. I later learned that the notebook and disc belonged to Detective Matthews and he dropped them on the grass as the confrontation between he and Canley unfolded.

13 DATE / TIME OF REPORT 02/01/07/ 2:15 PM	14 REPORTING OFFICER / ID NO / DIV / UNIT Sgt. W. Ayub/#3318/Special Services	15 APPROVED BY / ID NO 
---	--	---

NARRATIVE REPORT VENTURA COUNTY SHERIFF'S DEPARTMENT

Page 4 of 6

Continuation

AGENCY IDENTIFIER CA0560000

1 RD 9072	2 BEAT 9G01	3 RB NUMBER 06-30492
--------------	----------------	-------------------------

4 CODE	5 ITEM	6 QTY.	7 ITEM NAME	8 BRAND / MAKE MANUFACTURER	9 MODEL NAME OR NUMBER	10 MISC. DESCRIPTION	11 IDENTIFICATION / SERIAL NUMBER	12 VALUE
--------	--------	--------	-------------	-----------------------------	------------------------	----------------------	-----------------------------------	----------

I continued examining the incident scene, and I found a pair of acceleration scuffmarks in the third parking stall south of the parking area entrance, on the west side of the parking lot. Each of the scuffmarks were approximately 3 feet in length and appeared to have been freshly created based on the black powdery rubber residue I could see on the surface of the scuffmarks. The scuffmarks were in such a position within the stall that they appeared to have been made by the rapid acceleration of the rear wheels of a vehicle that was parked nose in (or the front wheels of a vehicle that was backed into the stall). Senior Deputy Godfrey, who responded to the scene to prepare a factual diagram, measured the scuffmarks and found them to be approximately the same size as the exterior wheelbase of the rear tires on the Ford F-150 pickup. I found no other fresh acceleration or deceleration scuffmarks on the parking lot.

I noted four expended silver colored .40 caliber Speer cartridge casings lying on the asphalt near the southern most portion of the entrance to the parking area. A fifth casing was found lying in the raised flowerbed that borders the southern most portion of the entrance to the parking area. All of the casings were within approximately 3 feet of each other.

In the driveway of the parking area immediately adjacent to the first parking stall south of the entrance to the parking area was a field of automotive fluid. The fluid field began at the first parking stall south of the parking area entrance and led to the underside of the engine compartment area of the Ford F-150 pickup where it pooled at the north curb line of the parking area. I could smell the distinct odor of radiator coolant emanating from the fluid field. Near the beginning of the fluid field, I noted a piece of copper bullet jacketing and a fragment of lead. I noted another piece of copper bullet jacketing under the marked police vehicle, which was parked across the fluid field. Refer to Senior Deputy Godfrey's diagram and the crime scene images for additional information.

I examined the white Ford F-150 pickup, and I noted that each of its four tires appeared to be properly inflated. I saw minor collision damage on the driver's side and front bumper of the vehicle, and miscellaneous scratches and dings on the truck body. I could see that the truck's driver's side window and passenger side window were partially rolled down, and I could see scratches and handprints on the exterior of the window. I looked into the truck from the exterior and noted the gear selector was in "D" or "drive." I could see that the ignition was in an

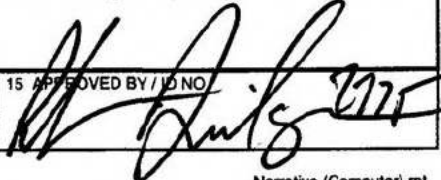
13 DATE / TIME OF REPORT 02/01/07/ 2:15 PM	14 REPORTING OFFICER / ID NO / DIV / UNIT Sgt. W. Ayub/#3318/Special Services	15 APPROVED BY / ID NO 
---	--	---

NARRATIVE REPORT VENTURA COUNTY SHERIFF'S DEPARTMENT

Page 5 of 6

Continuation

AGENCY IDENTIFIER CA0560000

1 RD 9072	2 BEAT 9G01	3 RB NUMBER 06-30492
--------------	----------------	-------------------------

4 CODE	5 ITEM	6 QTY.	7 ITEM NAME	8 BRAND / MAKE MANUFACTURER	9 MODEL NAME OR NUMBER	10 MISC. DESCRIPTION	11 IDENTIFICATION / SERIAL NUMBER	12 VALUE
--------	--------	--------	-------------	-----------------------------	------------------------	----------------------	-----------------------------------	----------

"off" position, and I noted the vehicle keys were still in the ignition. I could also see a small folding knife wedged into the space between the driver's seat cushion and the seat back. The blade on the folding knife was open; however, it appeared to have been wedged in the seat for some time based on the amount of debris that was accumulated on top of the knife. I also noted a pair of binoculars sitting on the seat cushion of the front passenger's seat.

As I examined the Ford F-150, I noted two apparent bullet strikes on the front grill area of the truck. The first impact I noted was on the front bumper. I could see the bullet imbedded in the metal of the bumper without penetrating the metal. The second impact penetrated the truck's plastic grill and traveled through the radiator and into the engine compartment. I believe the fragments from this particular bullet were the ones I noted at the beginning of the fluid field the truck left behind. I also noted three bullet holes in the truck's windshield, directly in front of the driver's seat. I could see corresponding damage to the truck's dashboard from the bullets that passed through the windshield.

I observed several items of clothing, various emergency medical supplies, a cellular telephone, a butane lighter, knit gloves, white tennis shoes, an expended bullet, and a large caliber black handgun lying on the ground, next to the left front tire of the truck. Based on statements of witnesses I obtained, the clothing was removed from Canley during attempted life saving procedures. I also learned that the personal property was removed from Canley's person, including the black handgun, which had been found tucked in the right side waistband of Canley's pants by attending paramedics/firefighters. Much of the clothing and the handgun were soaked in radiator fluid.

Field Evidence Technician [REDACTED] responded to the incident scene and took overall digital images. He then placed photo markers on each item of evidence and took more overall digital images of the scene and of each item of evidence.

I examined the firearm that had been found on Canley's person by emergency medical personnel. I found the pistol to be manufactured by Hi-Point Firearms with a model number of JHP45ACP and a serial number of [REDACTED]. The pistol was black in color and manufactured in .45 ACP caliber. I noted that the weapon's safety was "on," meaning the thumb safety lever would have to be depressed before the weapon could be fired. I removed the magazine from

13 DATE / TIME OF REPORT 02/01/07/ 2:15 PM	14 REPORTING OFFICER / ID NO / DIV / UNIT Sgt. W. Ayub/#3318/Special Services	15 APPROVED BY / ID NO 
---	--	---

NARRATIVE REPORT VENTURA COUNTY SHERIFF'S DEPARTMENT

Page 6 of 6

Continuation

AGENCY IDENTIFIER CA0560000

1 RD 9072	2 BEAT 9G01	3 RB NUMBER 06-30492
--------------	----------------	-------------------------

4 CODE	5 ITEM	6 QTY.	7 ITEM NAME	8 BRAND / MAKE MANUFACTURER	9 MODEL NAME OR NUMBER	10 MISC. DESCRIPTION	11 IDENTIFICATION / SERIAL NUMBER	12 VALUE
--------	--------	--------	-------------	-----------------------------	------------------------	----------------------	-----------------------------------	----------

the pistol and I found it to be loaded with seven .45 ACP rounds. I then opened the pistol's action and found a single .45 ACP round in the firing chamber. After clearing the weapon, I gave it to [REDACTED]

After taking digital images of the scene, [REDACTED] collected and packaged each item of evidence. He later booked the evidence into a secure storage locker at the East County Sheriff's Station. Refer to [REDACTED] property report for additional information.

13 DATE / TIME OF REPORT 02/01/07/ 2:15 PM	14 REPORTING OFFICER / ID NO / DIV / UNIT Sgt. W. Ayub/#3318/Special Services	15 APPROVED BY / ID NO  2725
---	--	--

1 RD 9072	2 BEAT 9G01	3 RB NUMBER 06-30492
--------------	----------------	-------------------------

4 CODE	5 ITEM	6 QTY.	7 ITEM NAME	8 BRAND / MAKE MANUFACTURER	9 MODEL NAME OR NUMBER	10 MISC. DESCRIPTION	11 IDENTIFICATION / SERIAL NUMBER	12 VALUE
--------	--------	--------	-------------	-----------------------------	------------------------	----------------------	-----------------------------------	----------

Supplemental Case Cleared

Gang Domestic Hate Child Abuse Elderly Abuse

Connecting Report Numbers:

Code Section / Description: Officer Involved Shooting

Reclassify To:

Code: P **Name:** Canley, Adrian d.o.b. 04/01/1981

Transcript of Matthews Walk-thru

On 02/01/06, I reviewed the digital audio recording Detective Rob Davidson created of the statement and walk-thru demonstration Detective Shane Matthews provided concerning his encounter and subsequent shooting of Adrian Canley on 11/14/06. Detective Davidson provided me with a copy of the recording, which I submitted for transcription. On 01/31/07, I received a typewritten transcript of the audio recording.

I listened to the entire audio recording, and I made some minor editing corrections to the written transcript. The typewritten transcript is now an accurate representation of the contents of the digital audio recording. Refer to the attached transcript and the digital audio recording for specific details.

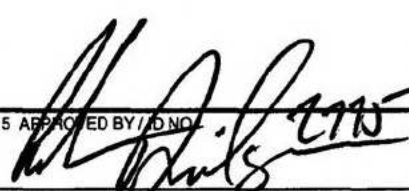
13 DATE / TIME OF REPORT 02/01/07/ 2:15 PM	14 REPORTING OFFICER / ID NO / DIV / UNIT Sgt. W. Ayub/#3318/Special Services	15 APPROVED BY / ID NO. 
---	--	--

Ventura County

Ventura County Sheriff's Department Memorandum

To: Major Crimes Date: January 30, 2007

From: Sergeant Bill Ayub

Subject: Shane Matthews

Re: 06-30492

Date of Interview: November 15, 2006

Time of Interview: 0002 hrs

Case Catalyst Operator: 

Legend: RD = Rob Davidson
SM = Shane Matthews
BA = Bill Ayub
SR = Stacy Ratner
BH = Bill Hadden
RS = Rick Shimmel
BK = Brian Keighron
LS = Lance Steaman
DM = Dave Murray
TI = Todd Inglis

(SHANE MATTHEWS WALK-THROUGH)

1 RD: Okay. The date is November the 15th, 2006. It is
2 approximately two minutes after midnight. This will be a walk-thru
3 with Detective Shane Matthews regarding an officer-involved
4 shooting that took place in a parking lot at [REDACTED] at
5 approximately 1800 hours. I'm going to go ahead and go around and
6 have everyone introduce themselves as being present for the
walk-thru just so that I don't forget any names.

8 I'll -- I'll announce my partner Bill Ayub, obviously
9 Detective Matthews.

10 BH: Bill Hadden.

11 RS: Rick Shimmel.

12 SR: Stacy Ratner.

13 BK: Brian Keighron.

14 LS: Lance Steaman.

15 DM: Dave Murray.

16 TI: Todd Inglis.

17 RD: Okay. And those are the -- the people that are
18 being present for the walk-thru. And for the benefit of tape we'll
19 be beginning the walk-thru at the entrance to a -- to the small
parking lot where the incident took place. The scene has already

1 been processed, photo markers are -- have been left in place for
2 our benefit and I believe some evidence is still present. The
3 scene's still being processed.

4 So Shane, what we're going to do as I told you or alluded
5 to earlier, is we're going to start here and I'd like you to
6 describe for us if you could just in general what brought you here.
7 Okay? Not the incident at all. Just what brought you here and
8 what the conditions were, were you here, who you were talking to,
9 that kind of stuff. Just kind of introduce us to -- to why you
10 were here.

11 SM: I came here just after 5:00 o'clock to interview a
12 witness slash suspect in a grand theft that I was investigating
13 from GNC at the Oaks mall. He lives in Apartment [REDACTED] which is
14 south from here up the stairs on the second level. I walked over
15 to the apartment, I knocked on the door. His mom and his brother
16 answered. His -- the -- the person I was trying to contact, his
17 name was [REDACTED] His brother [REDACTED] and his mom answered the
18 door. They told me he was not at the location. I gave them my
19 name and my phone number and asked them to have him call me.

20 I already knew what [REDACTED] looked like 'cause I had
21 pulled a DMV photo earlier of him. I turned my recorder off, I
22 came down the stairs. I -- as I was walking, exited the bottom
23 portion of the stairs and was walking past this first couple cars,
24 [REDACTED] passed me walking towards his apartment. I recognized him
25 and I asked if he was [REDACTED] He said yes. I introduced myself
26 and we had a conversation on the sidewalk in front of that mini
27 van, the white mini van for approximately ten minutes.

28 RD: Okay. I'm going to stop you just for the -- for our

benefit. The -- the white mini van is the last vehicle in the southwest most corner of the parking lot. It's the -- it's the last vehicle or the first vehicle depending on which way you're coming into the parking lot. And the apartment complex would be to the southeast of you. And then there's another lower one-story building that's to your west.

SM: Actually a parking structure.

RD: And it's a -- okay. It's a parking structure.

SM: Correct.

RD: So go ahead and continue. Okay, correct.

SM: So after about ten minutes, I asked him if he wanted to go into his apartment and sit down and continue our conversation. He said no, let's just sit on the stairs. So we walked over to the stairs that you see right there on south of the mini van. He sat on the stairs and I stood next to him while we talked about the case. We spoke for about a half an hour total.

At -- towards the end of our conversation a guy appeared behind me maybe ten feet behind me. I don't know where he came from or how he got there, all I heard was something to the effect of, I know you're the fuckin' sheriff and I'm not-- and you're not going to take me. And I turned around and I saw Hispanic male about 5'10, a hundred and seventy, black-hooded sweatshirt, black pants. I believe black shoes and he was pacing back and forth and kind of -- kind of animated in his hand movements and mad-dogging me and staring at me. And my initial opinion was he's high on some kind of stimulant and he's a gang member. He looked like a gang member, shaved head.

I don't remember saying anything to him at that time. I

1 just kind of turned my back and turned back to -- looked at [REDACTED]
2 and [REDACTED] just kind of shrugged his shoulders like I don't know
3 who the guy is. So he -- the -- the Hispanic male walked westbound
4 on the sidewalk kind of out of my view. [REDACTED] and I wrapped up
5 our conversation.

6 At that time he -- the guy walked back over and made
7 another comment, something to the effect of fuckin' sheriff ain't
8 going to take me. I'm not -- you're not going to take me alive.
9 Words to those effect. At that point I told [REDACTED] thanks for
10 talking to me. I turned and I -- I headed for the suspect who,
11 he's maybe fifteen feet in front of me.

12 RD: Okay.

13 SM: To -- 'cause now -- now I don't -- I don't know
14 what's going on. He's telling me I'm not going to take him alive.
15 It looked -- it appeared to me that he had just been chased. Like
16 he had that adrenaline rush going, he's high, he'd just been chased
17 like somebody's looking for him. And he knew I was a sheriff.
18 He's saying, fuckin' sheriff ain't going to take me alive so I was
19 going to contact him.

20 RD: Okay.

21 SM: And he immediately bolted.

22 RD: Okay. With that, let's move down to that area so
23 that we're -- we're kind of a little more in the area that we're
24 now talking about.

25 SM: Okay.

26 RD: So for the benefit of the tape, we're going south
27 through the entrance to the parking lot and we're now on the -- the
28 walkway that leads along the west side of the parking lot and we

1 are walking towards the stairwell and the white mini van that we
2 referenced earlier.

3 So whenever you think you're in a spot where you can kind
4 of point things out, go ahead and stop and we'll continue.

5 SM: I'll show you where I was standing, where he was
6 standing. I was standing (INAUDIBLE).

7 RD: Hold on. Hold on a second.

8 That's all right.

9 SM: I was standing right here.

10 RD: Okay. Let's --

11 BH: (INAUDIBLE) identify (INAUDIBLE).

12 SM: I'm standing at the base of the stairs on the
13 elevated platform to the stairs.

14 RD: Okay.

15 SM: Kind of right now 'cause I'm freezing cold.

16 RD: Here. Hold on a second. I hope you're an 'SC fan.

17 SM: Huh?

18 RD: I hope you're an 'SC fan.

19 SM: I am, actually.

20 RD: Good. For the benefit of -- of the tape, I'm just
21 going to ask you what is the address of this building if you know.

22 SM: It's -- the address where I was going?

23 RD: Yeah.

24 SM: It's [REDACTED]

25 RD: 210. Okay. So this is [REDACTED] 'Cause there's --
26 seems to be a lot of buildings in the area so I --

27 SM: Well, the sign at the bottom says 2222.

28 RD: Uh-huh.

1 SM: Apartment [REDACTED] up here.

2 RD: Okay. So we're at the --

3 SM: So --

4 RD: -- stairwell that leads to the second floor of that
5 building.

6 SM: Right. I'm standing here, suspect's standing at the
7 intersection by the -- the water spot is. Where the two sidewalks
8 meet.

9 RD: Okay. There's a sidewalk that goes to the --
10 north -- it's actually all, all points of the compass. North,
11 south, east and west. With the -- with the walkway that we just
12 came heading to the north and the suspect was standing at that
13 intersection.

14 Go ahead.

15 SM: So I -- as soon as I stepped off, I stepped off of
16 this platform here and -- and as soon as I took a couple of steps
17 towards him he took off running that way.

18 RD: Okay. Northbound through the -- or on the west
19 sidewalk.

20 SM: He went northbound on the sidewalk.

21 RD: Okay.

22 SM: West of the parking lot.

23 RD: Okay.

24 SM: Along the -- the trees there.

25 RD: Okay.

26 SM: I chased after him. As he -- as he started running,
27 he was -- he was fumbling with something and he was reaching into
28 the front of his waistband. I don't know if it was his waistband

1 or his sweatshirt or what it was but he was reaching in front and I
2 couldn't see. And he'd already made a comment about not being
3 taken or not being taken alive and either or both of those. I
4 can't remember. So as I'm running, I threw my notebook down, which
5 is next to the tree, the second tree along the sidewalk.

6 RD: Okay. Let's -- let's actually start walking back up
7 that way now.

8 SM: I remember about right --

9 RD: Hold on until we get up there just (INAUDIBLE).

10 SM: Well, I'll start here because --

11 RD: Okay.

12 SM: -- right about here is where I remember see --
13 seeing him reaching for something.

14 BH: And here is where?

15 SM: I'm sorry, the intersection of the sidewalks.

16 RD: Okay.

17 SM: So I remember having my notebook in my right hand
18 and about here is where I -- I drew my gun. I'm left-handed so I
19 drew my gun with my left hand and I threw my notebook down and --

20 RD: We're now proceeding north on the west walkway.

21 SM: And I was telling him to stop, Sheriff's Department,
22 stop. His truck was parked in the third parking space south of the
23 planter next to this blue car.

24 RD: Okay.

25 SM: He got into the driver's -- the truck was parked
26 nose in. He jumped in the driver door, I came up to the driver
27 door with my gun out yelling Sheriff's Department, stop. Get out
28 of the truck, get out of truck. The window was half down. He's --

1 he was hitting -- I was -- if I remember, trying to grab the window
2 but he was hitting the window trying to keep my hands off of it. I
3 tried to break the window twice by hitting my -- the -- the nose of
4 my gun against the window so I could grab it. It -- the window
5 didn't break. By that time he had the truck on and I grabbed the
6 driver handle and he -- he backed out quickly.

7 RD: Okay.

8 SM: So when he backed out I kind of went with -- I went
9 with the truck, not -- not on purpose but kind of just -- it kind
10 of pulled me out. So then his truck is here and I'm now standing
11 in front of the truck.

12 RD: Okay. Let -- for the benefit of the tape, you're --
13 you're motioning that he is backed out. Is the back of his truck
14 now facing the -- the building that you were just at? In other
15 words, the -- the tail end of the truck is south and the nose of
16 the truck is north.

17 SM: Correct.

18 RD: Okay.

19 SL: So the -- on -- on the -- I'm in front of the truck
20 but more towards the driver's side. I -- honest, I said to myself,
21 how did you end -- you know I'm thinking, how did I end up in front
22 of the truck 'cause I didn't -- I didn't intentionally end up in
23 front of the truck, just the -- the way the truck came out and me
24 holding on I just ended up here. I'm yelling at him to stop the
25 whole time. I start backing up, he -- and he's yelling at me the
26 whole time through the window. You know, fuck you. I -- I can't
27 remember everything that he was saying but he was pretty pissed
28 off.

1 RD: Okay. The -- the tone of what he's saying to you,
2 you can tell that he's pissed off?

3 SM: Yeah.

4 RD: Okay. And you made out -- are you sure that he said
5 fuck you? Or I mean, there was a lot --

6 SM: There's a lot of F's in there. I don't -- I don't
7 remember.

8 RD: Okay. Okay.

9 SM: If the "you" came out but --

10 RD: Okay.

11 SM: So I'm in front of the truck. I started
12 backpedaling to get away from the truck. He started coming
13 forward. I fired two rounds at the truck. I could -- at the truck
14 that was coming at me. I don't remember hearing the -- don't
15 remember hearing the -- the gunshots but I remember staring -- I
16 was staring at the grill of the truck as it was coming and that's
17 exactly where the shots went. And I knew my gun had fired because
18 of the recoil and the -- the pieces of the grill kind of went
19 flying. You know, it broke apart. I yelled stop again. I was
20 still just -- as this is going on I'm still walking backwards. So
21 I'm thinking about right -- right in here.

22 RD: In here we're in front of the parking space?

23 SM: It was second parking space.

24 RD: Okay. So we've moved now north a parking space.

25 SM: He revved the engine. I -- I heard the tires squeal
26 and, I mean, it happened -- it felt like it was in slow motion but
27 I know it was -- it was super quick. It was boom, boom. Stop,
28 stop. And then (tire screeching noise) and then boom, boom, boom.

1 I -- I remember specifically looking right at his head that was in
2 the windshield and aiming at his head when I fired. And the
3 rounds, I watched the rou- -- the -- where the windshield meets the
4 dashboard it kind of splintered or the -- the windshield cracked
5 and splintered and as he's coming at me I -- I fired the rounds and
6 peeled off and he -- he was yelling you shot me, I'm hit. And then
7 the truck just slowly rolled forward and it stops where you see it
8 now.

9 RD: Okay.

10 SM: So then I -- I ran up to the back of the truck and I
11 was yelling at him not to move, don't move. Let me see your hands.
12 I -- I remember yelling who are you? You know, what -- why did you
13 do this or what were you doing? Something to that effect.

14 I yelled to [REDACTED] who was standing about where Kadosono
15 is, about the third parking space down, to call 911 'cause I didn't
16 have a radio. I remember as I'm crouched behind the -- the
17 tailgate of the truck on the driver's side --

18 RD: You're motioning that you -- you're still drawn
19 down?

20 SM: I'm drawn down, I'm crouched behind the cover of the
21 tailgate.

22 RD: Okay.

23 SM: (INAUDIBLE) concealment not cover but -- and pulling
24 my Nextel out and trying to finger through my Nextel to -- to reach
25 any patrol unit. I tried 9G and 9D a couple times. It didn't go
26 through. And then I got through to 9041, who's Paul Ferruzza. He
27 acknowledged me and I just told him I'm at [REDACTED] shots
28 are fired, I need Code 3 backup right now. He said I'm en route

1 and hung up. I mean, it was that quick.

2 And about that time [REDACTED] asked me what my last name
3 was again so he could tell the dispatcher. I said Matthews.

4 The guy the whole time is -- is mo- -- yelling you shot
5 me. I'm hit. He's kind of moaning. I -- I back up and go to --
6 go to the back of my van. I -- I had a flashlight in the back of
7 the van. I grabbed my flashlight, I go back to the tailgate and I
8 shine my light. The driver's door was open. He had opened the
9 door so I could see a portion of his shoulder and a portion of his
10 head.

11 And he was no longer talking, he was just kind of
12 moaning. I told him let me see your hands, let me see your hands.
13 I approached. He was slouched over and both his hands were out
14 like this. I could see some blood on the -- on the front of his
15 jacket or his sweatshirt. I do remember asking him before I went
16 and got my flashlight, where -- where are you shot? And he said in
17 my chest. He had the look -- he had the I'm dying look. And he
18 was moaning and I've seen it before.

19 I decocked, I holstered my weapon, I grabbed him under
20 his -- his armpits, I drug him out of the truck, I laid him on the
21 ground, I opened his airway. By that time I could hear a couple
22 units pass by the entrance going Code 3. I was telling the
23 suspect -- I don't even know his name -- you know, stay here, stay
24 here, breathe, take some -- take some deep breaths. He was -- he
25 was moaning on his exhales, but nothing else.

26 I ran -- don't remember this -- I don't remember the
27 order. I either at that point ran over and flashed my light at the
28 units so they would know where I was and came back.

1 At some point, I think it was before that though, some
2 smaller Hispanic male ran over and asked what was going on. I
3 asked him if he knew the -- the guy. He said no. And then I told
4 him to get away and to go over - [REDACTED] -- [REDACTED] was standing
5 right in here on the sidewalk by the fire hydrant.

6 RD: Okay. There's a -- just for the benefit, there's a
7 turn-around to the west of the parking lot with a large tree in the
8 center of it. And on the south side of the turn-around that leads
9 to the parking structure referenced earlier is where we're
10 referring to.

11 SM: I told him to go stand with [REDACTED] and wait over
12 there and then I think I ran over and flashed my light.

13 Anyway, Deputy Natoli, Laura, and Keith Hall a motor
14 officer were the first two next to arrive. That's her car, her
15 police car parked behind the suspect vehicle. A -- initially they
16 asked me if I was all right. I told them I was. They asked me if
17 there was any outstanding suspects. I told them there was not.
18 And they asked me what I needed. I told them I needed a first aid
19 kit, some gloves and I needed some -- start setting up some crime
20 scene tape.

21 Put on gloves and started getting out some pressure
22 dressings. I asked Laura if she had a knife to cut off the
23 suspect's sweatshirt. And I made sure I told her cut -- cut the
24 left side of the sweatshirt, not -- not the right side 'cause if
25 it -- the blood was kind of on the upper right portion. She
26 started cutting it. By that time Deputy Berg showed up. He had a
27 pair of scissors, like medical scissors so he cut through the
28 sweatshirt and the T-shirt and we were able to see the bullet hole

1 in the upper right portion of the suspect's chest. By this time he
2 was -- eyes were starting to roll back. There was no response.
3 His breathing was shallow although he still had a carotid pulse but
4 he had no radial pulse.

5 RD: Okay. I'm going -- I'm going to stop you right
6 there. You're -- you're describing some very particular medical
7 terms. We've all had first aid training but I know through knowing
8 you that you've had some additional training so can you -- I'm just
9 going to as quick time-out here, can you just real briefly tell
10 us -- you don't have to give us a -- an entire resume but just tell
11 us what you're basic understanding of -- of medicine or first aid
12 is.

13 SM: I'm an EMT and I work at the air unit. I've been
14 involved on many medical calls. Prior to my employment here at the
15 sheriff's department, I worked at Community Memorial in surgery and
16 in the emergency room and I was an EMT there also.

17 RD: Perfect. Okay. Go ahead and continue.

18 SM: So I had checked his radial pulse, which is on his
19 wrist. There was nothing there. Checked his carotid both sides.
20 He had a carotid pulse on both sides of his carotid on his neck. I
21 got out the pocket mask. I gave him two or three breaths to assist
22 his breathing 'cause it was pretty shallow.

23 At that point Deputy Berg said why don't you let me
24 handle the medical stuff. And Berg is an EMT and I work with him
25 at the air unit so I know he's capable of doing that. And I said
26 it's probably a good idea. So I walked with Keith Hall over to
27 about the edge of the crime scene tape at the -- at the entrance to
28 this little parking lot.

1 RD: Okay. So you walked to the west?

2 SM: Right.

3 RD: Okay.

4 SM: Keith asks me -- asked me -- because they didn't
5 know what had all happened, asked me how big does the crime
6 scene -- where should the crime scene tape go? So I -- I helped
7 him put up the crime scene tape so that it was covering at least
8 what I thought was -- was needed -- that needed to be covered.

9 RD: Okay.

10 SM: And then multiple units started showing up and they
11 were -- you know, I basically -- I told them that [REDACTED] had seen
12 the whole thing. And I told them about the Hispanic male that we
13 never did find him or at least I -- I never saw if he was located
14 or not. But I -- I described him and they were looking for him.

15 And then about ten minutes later I was with Paul Ferruzza
16 at his unit, who Cary Peterson, Sergeant Peterson assigned him to
17 be with me and we were just sitting over at the unit, kind of away
18 from the situation. And I looked down and saw the red light in my
19 pocket and realized that my recorder had been on the whole time.
20 So I pulled the recorder out. I looked at it, said like fifty
21 something minutes. So I knew that I had included [REDACTED]
22 conversa- -- you know, our -- my interview with [REDACTED] and the
23 shooting. So I turned it off in front of Paul or I stopped the
24 recording. I turned it off and I gave it to him and I told him you
25 better hold on to this, it's got the whole shooting on the -- on
26 tape. And then -- and then I sat in the car.

27 RD: Okay.

28 SM: And waited.

1 RD: All right.

2 SM: (INAUDIBLE).

3 RD: I'm going to kind of walk you back through it just
4 to make sure I have a real accurate picture of what you just told
5 us. If I get anything wrong, correct me. I'm also going to ask a
6 little more probing questions now about just what you were
7 experiencing as you went through this. And then we'll kind of
8 conclude this (INAUDIBLE) asking additional questions. Okay?

9 SM: Okay.

10 RD: All right. So you're here to interview a guy named
11 [REDACTED] who lives in Apartment [REDACTED] second floor, totally unrelated
12 as far as we can tell to the situation?

13 SM: Correct.

14 RD: Having to do with a -- a theft from a GNC in the
15 Oaks mall?

16 SM: Correct.

17 RD: You're here, you -- at first you can't contact him
18 because he's not home but as you're leaving you notice he's walking
19 back or apparently to his apartments. You identify yourself,
20 figure out that it's him and you guys start talking?

21 SM: Correct.

22 RD: As you're talking to him, a guy kind of appears out
23 of nowhere kind of about ten feet away or so and he starts making
24 comments to you, you're not going to -- you know, you're a fucking
25 cop, you're not going to get me. Things to that nature. Can you
26 remember anymore what he said to you? Can you give me --

27 SM: I remember --

28 RD: -- the gist of what he's telling you?

1 SM: I remember that he thought [REDACTED] was a cop too.
2 He -- 'cause he said you -- I know you -- I know you guys are
3 sheriffs and you're not going to get me. Or you're not going to
4 take me.. You know, as I think back on it, his -- it was almost
5 challenging like he -- 'cause he stood there for a few -- a few
6 moments as if he wanted me to respond and I didn't. I turn -- I
7 turned my back on him and went to talking to [REDACTED] like I didn't
8 want to address it right at that moment.

9 But when he returned, then in my mind said something's --
10 I mean, obviously something's not right. This guy need to be
11 talked to and something -- I mean, to me a -- I mean, I've had drug
12 training, to me the guy was -- was high on meth or coke or some
13 kind of stimulant. Couldn't -- he was, you know, was pacing back
14 and forth. He couldn't hold still. He's -- he's -- honestly, he
15 had that -- that meth paranoia almost going. You know how they get
16 like everybody's after him? That's how it seemed like he thought I
17 was after him and he yet I didn't even know who the guy was.

18 RD: Okay.

19 SM: Um --

20 RD: Okay. So that -- so that takes place as you were
21 finishing up with [REDACTED]

22 SM: Correct.

23 RD: And then you turn your attention, he's now appeared
24 again and you turn your attention to him?

25 SM: Correct.

26 RD: And that's when you come down off the landing.

27 SM: Uh-huh.

28 RD: And as you take a couple steps he bolts?

1 SM: Right.

2 RD: And he starts running towards the parking lot, which
3 is north of you?

4 SM: Right.

5 RD: Okay. He runs and as he's running, describe for me
6 a little more. You say he's -- he's fumbling with something in his
7 waistband. Just talk about that a little more. Tell me what
8 you're thinking, what you're -- and what you're feeling as -- as
9 that is going on. What is your perception of what he's doing?

10 SM: As he's running, he's -- he's crouched over and
11 he's -- he's reaching with both hands to his front which I can't
12 see. And he's already told me that I'm not going to take him --
13 and I'm not going to take him alive. So I'm -- I assumed he's
14 going for a weapon. That's why I threw my notebook and pulled my
15 gun out as soon as I started running so that if he was to turn and
16 have a weapon I would already be up and on target to address that
17 threat.

18 But he never turned towards me and when his hands came
19 out at the truck I didn't see anything in them. I didn't -- I
20 don't even remember seeing any keys. I think I just answered the
21 question.

22 RD: It is. Okay. So -- so you've -- now we've walked
23 up and now he's -- he's at the car and he's getting in. How -- as
24 he's climbing into the -- the driver's door, how far back are you
25 from him? If -- if you can --

26 SM: I --

27 RD: -- estimate that.

28 SM: I would just -- I would imagine the same distance,

1 fifteen feet, maybe a little more.

2 RD: Okay.

3 SM: I -- I didn't gain anything on him when -- when I
4 ran after him.

5 RD: Okay. All right. So now he's getting -- he's
6 getting into the car, the -- and he's pulling it shut. You're
7 coming up to the -- to the car. Now, you're gunning him -- in
8 other words, you have your gun pointed at him and what are you --
9 what are your directives?

10 SM: I'm yelling at him, stop, Sheriff's Department, get
11 out of the truck. Let me see your hands. Get out of the truck.
12 Stop. Stop what you're doing and he's -- he's yelling back at
13 me -- God, I can't remember specific words but I want to say he --
14 I -- I can't remember what he was saying.

15 RD: That's fine.

16 SM: I just remember that he was yelling at me and he was
17 hitting at the window like trying to keep me from grabbing onto the
18 truck or --

19 RD: Okay.

20 SM: -- grabbing onto him.

21 RD: All right. He then starts the car?

22 SM: He starts the car. I tried to break the window when
23 he started the car. In my mind I had told myself there's no way
24 he's driving away, not in his condition. He's -- I mean, he --
25 something -- I mean, he was high and there's -- I mean, for him to
26 be driving that car around, there's no way. So I just remember
27 telling myself don't let him leave in the truck, don't let him
28 leave in the truck.

1 RD: Okay.

2 SM: When I hit the window and it didn't break I reached
3 for the door and I tried to open the door and that's when he -- he
4 backed out.

5 RD: Okay.

6 SM: And I -- I -- I went with the truck. I can't
7 remember if I held on or if I just instinctively just followed it
8 out. But when the truck came out, all of a sudden I'm standing in
9 front of it and I remember saying to myself how did I end up in
10 front of the truck? I was at the side before.

11 RD: Okay.

12 SM: And so I started -- and the whole time I'm yelling
13 stop, stop, Sheriff's Department. Stop what you're doing, you
14 know. And I -- I started walking back or I started backpedaling.
15 I don't -- I don't --

16 RD: Why -- why are you backpedaling? Let me ask that.

17 SM: 'Cause he's -- he's got the truck started and
18 he's -- looked -- he's coming after me. That's -- that's what I
19 believed. He's started to roll forward and he was revving the
20 engine and he -- so I don't know why I didn't sidestep but I was --
21 I was backpedaling and I fired two rounds at the truck. I remember
22 staring at the grill and seeing the grill break apart. And then
23 the screeching of tires or -- and thinking that he was going to run
24 me over and that I needed to shoot him in the head where I could
25 see. I -- I remember saying to myself shoot what you can see, and
26 all I could see was his head barely over the dash.

27 RD: Okay.

28 SM: So I -- I remember I was right on his -- on where

1 his head was and I fired.

2 RD: Okay.

3 SM: I thought it was two rounds but after counting the
4 rounds at the station, it turned out to be three.

5 RD: Okay. Tell me as -- as you hear -- you're hearing
6 the screeches and -- and he's starting to come forward. What --
7 what are you feeling at that point?

8 SM: I'm thinking I'm going to get run over.

9 RD: Okay.

10 SM: This guy's -- this guy's going to run me over. He's
11 in a -- he's in a big truck and he's gonna to do anything he can to
12 get away. And I -- I -- I still remember being in kind of
13 disbelief that I was in front of the truck 'cause I -- I couldn't
14 figure out how I got there but all I knew was that I was there and
15 I was backpedaling and I -- I fired the first two rounds, I saw
16 them hit the grill and -- it -- and I told myself that didn't do
17 anything and I came up to where his head was when he was still
18 coming forward. I remember saying stop really loud a couple of
19 times after the first two rounds and then -- and then he -- I
20 remember tires screeching.

21 RD: Okay.

22 SM: And him coming at me. I fired -- fired the three
23 rounds and peeled off and sidestepped and then at that point his
24 foot was definitely off the gas and he just -- he just coasted to
25 where the -- the truck is now. He wasn't going at any speed.

26 RD: Okay. All right. Hold, just a moment (INAUDIBLE).
27 Okay. For the benefit of -- of -- and at the station we kind of
28 covered this, but for the benefit of all those here, with the

1 exception of the red windbreaker that I gave you because it's cold
2 out here, are you dressed the way you were dressed when you -- when
3 confronted by this guy?

4 SM: Exactly.

5 RD: Okay. So you're wearing a -- a dark blue button
6 shirt with a -- with a tie, slacks. You have your -- your badge on
7 a belt clip. You've got your -- your gun in a holster, which is
8 readily visible. To the rear you have handcuffs in your -- in your
9 belt.

10 SM: Correct.

11 RD: And then around your neck on a lanyard you have your
12 sheriff's ID, which is white with a badge. As you're looking at it
13 to the left, your photo and a Sheriff's Department in -- in
14 lettering across the bottom.

15 SM: Except for your jacket this is exactly what I was
16 wearing.

17 RD: Okay. Now, when he walked up to you, if he came up
18 to you from your -- did he come to you from your -- he was on your
19 right-hand side? Or was he on -- which direction?

20 SM: I don't -- I don't know which direction he
21 originally came from.

22 RD: Okay.

23 SM: All I know is that he was standing right behind me
24 maybe ten feet away.

25 RD: Okay.

26 SM: And that I -- I wouldn't have known that he was even
27 there except for the fact that he said I know you're fuckin'
28 sheriff's and you're not going to take me.

1 RD: Okay.

2 SM: And that -- that's what made me turn around and took
3 to see who it was.

4 RD: Okay.

5 SM: He -- and then like I said, I didn't say anything
6 initially. He walked westbound on the -- on the sidewalk that runs
7 east and west and then reappeared maybe thirty seconds or a minute
8 later.

9 RD: Okay. All right. Now, you're over -- you -- you've
10 taken us through the -- the vehicle backing up. It's starting to
11 come forward, you fire two rounds into where you're looking, which
12 is grill area. You -- you see the rounds hit because you see
13 pieces of the car. You hear -- and I'm trying to put this in order
14 so correct me if I'm wrong. You hear tires screeching and you --
15 and the car is still coming towards you.

16 SM: Correct.

17 RD: You're afraid you're about to be run over so you --
18 in your mind you say shoot at what I can see. And so you fire, you
19 can just see his head above the steering wheel so that's where
20 you're aiming?

21 SM: Correct. Except that after I fired those first two
22 shots, I remember screaming really loud, stop, stop.

23 RD: Okay. Okay.

24 SM: I mean, and he was still yelling back at me. I
25 don't know what he was saying but he was yelling back at me.

26 RD: Okay.

27 SM: At that time.

28 RD: All right. Now his car rolls forward and comes to a

1 stop there. And -- and I -- and I feel like you've really
2 adequately described, you know, medically what was done there.

3 Did -- did you notice anything about what was on his
4 person? Did you ever look at what he physically had as you were
5 treating him?

6 SM: Once I laid him down and I opened his airway I --
7 I -- and I told [REDACTED] -- I don't know if I told him anything. I
8 don't think I told him anything at that point. I -- I -- there was
9 a -- a lighter hanging out of his right pocket kind of halfway. I
10 pulled that out, put it on the ground. I felt his -- his
11 sweatshirt pockets and there were -- found a cell phone. I reached
12 into his left pocket and found two black gloves, one of which I
13 believe had a crank pipe in it. I never saw the crank pipe but I
14 could feel it, set it aside. I reached under his back as far as I
15 could but I didn't get all the way but I couldn't feel anything
16 under his -- in the belt line under his back. And his arms, the
17 sleeves of his sweatshirts but that's about all I -- that's all I
18 patted down. Just those general areas real quick.

19 RD: Okay.

20 SM: And quite honestly, I wasn't concerned that he was
21 faking 'cause he had that -- he had the -- his color was fading,
22 his eyes are starting to roll back.

23 RD: Right.

24 SM: And I could see his hands clearly. There was
25 nothing in his hands.

26 RD: Right.

27 SM: So -- so I didn't think that --

28 RD: At that point he wasn't a threat to you?

1 SM: Right.

2 RD: Okay.

3 SM: I wasn't thinking, you know, continue searching. It
4 was more --

5 RD: Certainly.

6 SM: -- provide some help.

7 RD: And that -- okay. And that makes -- that certainly
8 makes sense. And that was of the extent of -- of your awareness
9 of -- of what he had on his person?

10 SM: Yeah. I -- I never looked inside the cab of the
11 truck except when I pulled him out but that entire time I was
12 looking at him and nothing else.

13 RD: Okay.

14 SM: He was the only person in the truck so he was my
15 threat as far as --

16 RD: Correct.

17 SM: -- as far as why I fired, so --

18 RD: Okay. I'm going to take you back to when you were
19 over here. Was there anyone else in the area with him or around
20 the truck during this time? Did you -- did you sense there was
21 any -- that he had a -- anyone with him?

22 SM: The only people I was aware of were me, [REDACTED] and
23 the -- and the suspect.

24 RD: Okay.

25 SM: That's the only people I saw in the area.

26 RD: Okay.

27 SM: The little Hispanic guy that came up after I had
28 pulled the suspect out of the truck, I have no idea where he was or

1 when he came (INAUDIBLE).

2 RD: Okay.

3 SM: And I just don't know.

4 RD: That's fine. Okay. I feel like I have a -- a
5 pretty accurate sense of everything.

6 Is there any -- does anybody have any questions they'd
7 like to route to us? No?

8 Okay. With that, I'm going to conclude the interview.
9 If I have any follow-up questions, I'll direct them to you, but
10 through your attorney. I'll just get ahold of him, make sure that
11 he's okay with recontact if -- if it ever became necessary.
12 And the time is about thirty-nine minutes after midnight.

NARRATIVE REPORT VENTURA COUNTY SHERIFF'S DEPARTMENT

Page 2 of 16 Continuation

AGENCY IDENTIFIER CA0560000

1 RD 9072	2 REAT 9G01	3 RB NUMBER 06-30492
--------------	----------------	-------------------------

4 CODE	5 ITEM	6 QTY	7 ITEM NAME	8 BRAND / MAKE MANUFACTURER	9 MODEL NAME OR NUMBER	10 MISC. DESCRIPTION	11 IDENTIFICATION / SERIAL NUMBER	12 VALUE
--------	--------	-------	-------------	-----------------------------	------------------------	----------------------	-----------------------------------	----------

attempting to contact a person named [REDACTED] in connection with the theft. Matthews believed [REDACTED] lived in apartment [REDACTED]. Det. Matthews was able to talk with [REDACTED] mother [REDACTED] and brother [REDACTED] at the apartment. They told Matthews that [REDACTED] was not home. Matthews left his name and phone number and asked that they have [REDACTED] call him.

As Matthews began to walk toward the parking lot to leave, he passed [REDACTED]. Det. Matthews said he knew what [REDACTED] looked like, as he had viewed a DMV photograph of him as part of his investigation. Matthews called to [REDACTED] and introduced himself to [REDACTED]. Matthews asked [REDACTED] if they could talk, and turned on his digital recorder and began the interview. They stood near a white minivan, which was the first vehicle in the southwest most corner of the parking lot and spoke for about 10 minutes.

After about 10 minutes, Det. Matthews asked [REDACTED] if he wanted to go inside to continue the interview. [REDACTED] declined but suggested they sit on the stairs that lead up to his apartment. [REDACTED] sat on the stairs and Matthews stood next to him while they continued to talk. Det. Matthews said they talked for about 30 minutes. Toward the end of the conversation a male (Canley) appeared behind Matthews. Det. Matthews said he was unsure where Canley came from, but he was about 10 feet away. Canley then said something to the effect, "I know you're the fucking Sheriff and you're not going to take me."

13 DATE / TIME OF REPORT 02/01/07 1:26 PM	14 REPORTING OFFICER / ID NO. / DIV / UNIT Detective R. Davidson#2775/Special Services	15 APPROVED BY / ID NO. SGT. W. J. [Signature] 3318
--	---	--

NARRATIVE REPORT VENTURA COUNTY SHERIFF'S DEPARTMENT

Page 3 of 16 Continuation

AGENCY IDENTIFIER CA0560000

1 RD 9072	2 BEAT 9G01	3 RB NUMBER 06-30492
--------------	----------------	-------------------------

4 CODE	5 ITEM	6 QTY	7 ITEM NAME	8 BRAND / MAKE MANUFACTURER	9 MODEL NAME OR NUMBER	10 MISC. DESCRIPTION	11 IDENTIFICATION / SERIAL NUMBER	12 VALUE
--------	--------	-------	-------------	-----------------------------	------------------------	----------------------	-----------------------------------	----------

[For ease of reading, I will refer to Canley by name. However, it should be noted that Detective Matthews did not know Canley's name during this incident.]

Det. Matthews turned around and saw Canley; Matthews described Canley and his clothing in a manner consistent with Canley's physical description and clothing. Canley was pacing back and forth and moving his hands in an animated manner. According to Matthews, Canley was "mad dogging" him. Matthews said his initial impression of Canley was that he was under the influence of drugs and a gang member. Matthews said this was based on his appearance and behavior.

Det. Matthews did not believe he said anything to Canley at that time. Matthews turned back to [REDACTED] who shrugged his shoulders as if to say he did not know who Canley was either. Canley then walked west down the sidewalk out of Matthews' view. Det. Matthews began to wrap up his conversation with [REDACTED]. At this point, Canley walked back over and made another comment to the effect, "Fucking Sheriff ain't gonna take me. I'm not - you're not going to take me alive." Det. Matthews then added, "[sic] words to those effect."

Det. Matthews thanked [REDACTED] for his time and turned to walk toward Canley, who was about 15 feet in front of him. Det. Matthews said he was unsure what was going on because he was being confronted by a subject who said he would not be taken alive; and it appeared to Matthews that the Canley had just been chased. Matthews continued saying, "He had that adrenaline rush going, he's high, he's just been chased, like somebody's lookin'

13 DATE / TIME OF REPORT 02/01/07 1:26 PM	14 REPORTING OFFICER / ID NO / DIV / UNIT Detective R. Davidson#2775/Special Services	15 APPROVED BY / ID NO Sgt. W. J. [Signature] 3318
--	--	---

him and he knew I was the sheriff. As
riff ain't going to take me alive.' So, I was going to
contact him and he immediately bolted."

th that said I suggested that we move to the area Det. Matthews
is now referring to in his explanation of what took place. We
aded up at the base of the stairs of [REDACTED].
et. Matthews told us that as soon as he stepped off the raised
ement landing he was on and took a couple of steps, Canley took
off running northbound on the sidewalk along the west edge of the
parking lot. Det. Matthews said he chased after Canley. When
Det. Matthews reached the intersection of the walkways that
crossed the area, he noticed Canley started fumbling with
something and reaching into the front of his waistband or
sweatshirt area. Det. Matthews pointed out that Canley had
already made a statement about not being taken alive, and he
indicated that Canley was running away from him and therefore had
his back to him. Det. Matthews said that as he was running, he
threw his notebook to the ground.

We then walked along the path in the direction Det. Matthews
chased Canley. Matthews told us he saw Canley reaching toward
his waistband and when he (Matthews) reached the intersection of
the walkways he drew his firearm with his left hand (he is left
handed) and threw his notebook to the ground. Matthews was
telling Canley to stop saying, "Sheriff's Department stop."
Canley's vehicle, a white pickup, was parked in the 3rd parking
space south of a planter which created a portion of the entrance,
to the parking lot. The pickup was parked "nose in." Canley got
into the car. Det. Matthews ran up to the door with his gun out

DATE / TIME OF REPORT 02/01/07 1:26 PM	14 REPORTING OFFICER / ID NO / DIV / UNIT Detective R. Davidson #2775 / Special Services	15 APPROVED BY / ID NO Sgt. W. J. [Signature] 2319
---	---	---

NARRATIVE REPORT VENTURA COUNTY SHERIFF'S DEPARTMENT

Page 5 of 16 Continuation

AGENCY IDENTIFIER CA0560000

1 RD 9072	2 BEAT 9G01	3 RB NUMBER 06-30492
--------------	----------------	-------------------------

4 CODE	5 ITEM	6 QTY.	7 ITEM NAME	8 BRAND / MAKE MANUFACTURER	9 MODEL NAME OR NUMBER	10 MISC. DESCRIPTION	11 IDENTIFICATION / SERIAL NUMBER	12 VALUE
--------	--------	--------	-------------	-----------------------------	------------------------	----------------------	-----------------------------------	----------

and shouted, "Sheriff's Department, stop. Get out of the truck. Get out of the truck." The window was half down and Det. Matthews remembered trying to grab the window but said that Canley kept hitting the window, trying to keep his hands off. Matthews tried to break the window twice by hitting it with the "nose" of his gun. The window did not break.

By this time, Canley had the pickup's engine started. Matthews told us, "I grabbed the driver handle [sic] and he backed out quickly. So when he backed out, I kinda went with, I went with the truck; not on purpose but kinda just - it kinda pulled me out." Matthews motioned and showed us that the tail end of the truck was now nearest the apartment building and the front of the truck was to the north. Matthews continued, "So the—I'm on the—I'm in front of the truck but more toward the driver's side. I said to myself, 'How did you end -- I'm thinking how did I end up in front of the truck, 'cause I didn't intentionally end up in front of the truck. Just the way the truck came out and me holding on, I just ended up here."

Det. Matthews said he continued to yell at Canley to stop the "whole time." Matthews started backing up. Matthews then made the observation that Canley was yelling at him (Matthews) the whole time through the window. Canley was yelling, "Fuck you" and other things that Matthews could not specifically recall, but Matthews had the impression that "he was pretty pissed off." I asked Matthews if it was the tone of Canley's voice that told him he was pissed off. Matthews said it was.

13 DATE / TIME OF REPORT 02/01/07 1:26 PM	14 REPORTING OFFICER / ID NO / DIV / UNIT Detective R. Davidson#2775/Special Services	15 APPROVED BY / ID NO SGT. W. J. [Signature] 3318
--	--	---

NARRATIVE REPORT VENTURA COUNTY SHERIFF'S DEPARTMENT

Page 6 of 16

Continuation

AGENCY IDENTIFIER CA0560000

1 RD 9072	2 BEAT 9G01	3 RB NUMBER 06-30492
--------------	----------------	-------------------------

4 CODE	5 ITEM	6 QTY.	7 ITEM NAME	8 BRAND / MAKE MANUFACTURER	9 MODEL NAME OR NUMBER	10 MISC. DESCRIPTION	11 IDENTIFICATION / SERIAL NUMBER	12 VALUE
--------	--------	--------	-------------	-----------------------------	------------------------	----------------------	-----------------------------------	----------

Det. Matthews continued to explain what was taking place saying, "So, I'm in front of the truck. I started back pedaling to get away from the truck. He (Canley) started coming forward. I fired two rounds at the truck - at the truck that was coming at me. I don't remember hearing the-I don't remember hearing the gunshots, but I remember star - I was staring at the grill of the truck as it was coming; and that's exactly where the shots went. And I knew my gun had fired because of the recoil and the pieces of the grill kind of went flying, or you know, broke apart. I yelled stop again. I was still - as this is going on, I'm still walking backwards."

Det. Matthews showed us how he moved backwards and at this time he indicated that he had moved north to an area in front of the second parking stall from the planter area referred to above. Matthews continued, "He revved the engine. I heard the tires squeal and - I mean it happened - it felt like it was in slow motion but I know it was, it was super quick. It was boom, boom, 'Stop! Stop!' and then [squealing noise] and then boom, boom, boom. I remember specifically looking right at his head that was in the windshield and aiming at his head when I fired."

Matthews described how he saw the rounds strike the area where the windshield meets the dashboard. Matthews again continued saying, "As he's coming at me, I fired the rounds and peeled off and he was yelling, 'You shot me. I'm hit.' And then the truck just slowly rolled forward and it stopped where you see it now." Det. Matthews ran up to the back of the truck and yelled for Canley not to move. Matthews also instructed Canley to show his hands. Matthews then yelled to Canley, "Who are you? Why did

13 DATE / TIME OF REPORT 02/01/07 1:26 PM	14 REPORTING OFFICER / ID NO / DIV / UNIT Detective R. Davidson#2775/Special Services	15 APPROVED BY / ID NO Sgt. W. J. [Signature] 3318
--	--	---

NARRATIVE REPORT VENTURA COUNTY SHERIFF'S DEPARTMENT

Page 7 of 16 Continuation

AGENCY IDENTIFIER CA0560000

1 RD 9072	2 BEAT 9G01	3 RB NUMBER 06-30492
--------------	----------------	-------------------------

4 CODE	5 ITEM	6 QTY	7 ITEM NAME	8 BRAND / MAKE MANUFACTURER	9 MODEL NAME OR NUMBER	10 MISC DESCRIPTION	11 IDENTIFICATION / SERIAL NUMBER	12 VALUE
--------	--------	-------	-------------	-----------------------------	------------------------	---------------------	-----------------------------------	----------

you do this? Or, what were you doing? Or something to that effect."

Det. Matthews said he yelled to [REDACTED], the person he had just interviewed, to call 911 because he did not have a radio with him. Matthews said he was crouched down behind the tailgate of the truck on the driver's side of the truck. He was going through his Nextel phone trying to find someone who could respond to help him. Det. Matthews said he was eventually able to reach Deputy Paul Ferruzza, who was working patrol shift 9041. Matthews told Ferruzza his location, shots had been fired and requested code three (lights and siren) assistance immediately. Deputy Ferruzza acknowledged Matthews and hung up. At about the same time, [REDACTED] asked Matthews for his last name so he could provide it to the dispatcher.

During this time, Canley was yelling, "You shot me. I'm hit." He was also moaning. Deputy Matthews worked his way over to his vehicle and retrieved a flashlight and went back to the tailgate. He shone his flashlight into the interior of the truck. The driver's door was open as Canley had opened the door. Matthews said he could see a portion of Canley's shoulder and head. Detective Matthews said that by this time, Canley had stopped talking and was now moaning. Matthews continued to tell Canley to show his hands and he began to approach Canley. When Matthews arrived at the driver's door he could see that Canley's body was slouched down. Detective Matthews said he could see some blood on the front of Canley's sweatshirt. Matthews commented that Canley had the "I'm dying look and he was moaning. I've seen it before."

13 DATE / TIME OF REPORT 02/01/07 1:26 PM	14 REPORTING OFFICER / I / D NO / DIV / UNIT Detective R. Davidson#2775/Special Services	15 APPROVED BY / I / D NO SGT. W. J. [Signature] 3318
--	---	--

NARRATIVE REPORT VENTURA COUNTY SHERIFF'S DEPARTMENT

Page 8 of 16 Continuation

AGENCY IDENTIFIER CA0560000

1 RD 9072	2 BEAT 9G01	3 RS NUMBER 06-30492
--------------	----------------	-------------------------

4 CODE	5 ITEM	6 QTY	7 ITEM NAME	8 BRAND / MAKE MANUFACTURER	9 MODEL NAME OR NUMBER	10 MISC DESCRIPTION	11 IDENTIFICATION / SERIAL NUMBER	12 VALUE
--------	--------	-------	-------------	-----------------------------	------------------------	---------------------	-----------------------------------	----------

Detective Matthews holstered his weapon and pulled Canley out of the truck and onto the ground. Detective Matthews said he then opened Canley's airway. During this time he could hear the sirens of a couple patrol cars going by the entrance to the apartment complex. Matthews told Canley to keep breathing and not to move. Matthews described Canley's breathing and said, "He was moaning on his exhales but nothing else."

At this point, Detective Matthews said two things happened and he was unsure which happened first; he ran over to the driveway and flashed his light at the patrol cars to get their attention and a, "smaller Hispanic male" ran over and asked what was going on. Det. Matthews asked the man if he knew Canley; the man said he did not. Det. Matthews directed the man to stand with [REDACTED] (the person he was interviewing earlier). Det. Matthews then said he thought he talked to the man first and then flashed his light at the patrol cars.

Deputies Natoli and Hall arrived. They asked Matthews if he was alright and if there were any outstanding suspects; Matthews told them he was fine and there were no other suspects. They then asked Detective Matthews what he needed. He told them he needed a first aid kit, gloves and for someone to put up crime scene tape to protect the scene.

Detective Matthews put on the gloves and retrieved some pressure dressings. He asked Deputy Natoli to cut Canley's sweatshirt off of him. Detective Matthews was specific in telling Deputy Natoli to cut the left side of the sweatshirt, because the blood was on

13 DATE / TIME OF REPORT 02/01/07 1:26 PM	14 REPORTING OFFICER / ID NO / DIV / UNIT Detective R. Davidson#2775/Special Services	15 APPROVED BY / ID NO Sgt. W. J. [Signature] 3318
--	--	---

NARRATIVE REPORT VENTURA COUNTY SHERIFF'S DEPARTMENT

Page 9 of 16 Continuation

AGENCY IDENTIFIER CA0560000

1 RD 9072	2 BEAT 9G01	3 RB NUMBER 06-30492
---------------------	-----------------------	--------------------------------

4 CODE	5 ITEM	6 QTY.	7 ITEM NAME	8 BRAND / MAKE MANUFACTURER	9 MODEL NAME OR NUMBER	10 MISC. DESCRIPTION	11 IDENTIFICATION / SERIAL NUMBER	12 VALUE
--------	--------	--------	-------------	-----------------------------	------------------------	----------------------	-----------------------------------	----------

the right side. At this point, Deputy Berg arrived and used a pair of medical scissors to cut the sweatshirt and underlying T-shirt off of Canley.

Detective Matthews said that once the clothing was off, he was able to see the bullet hole in the upper right portion of Canley's chest. Matthews continued, "By this time, he was -- eyes were starting to roll back, there was no response, his breathing was shallow; although he still had a carotid pulse but he had no radial pulse (Wrist)." I stopped Det. Matthews and pointed out that his description of Canley's condition seemed beyond basic first aid. I also stated for the tape and others, that I knew that he (Matthews) had more advanced medical training than first aid and I asked him to review his background for us. Detective Matthews stated that he was an Emergency Medical Technician (EMT) and worked at the Sheriff's Air Unit. He has responded on numerous medical flights. Prior to his employment with the Sheriff's Department, Matthews said he worked for Community Memorial Hospital in both the Surgery Unit and the Emergency Room as an Emergency Medical Technician.

Detective Matthews then continued telling us what took place after the shooting. Matthews said he checked for a radial pulse and found none; he checked Canley's carotid pulse on both sides of his neck and found that he had a pulse. Detective Matthews then said, "I got out the pocket mask. I gave him 2 or 3 breaths to assist his breathing, 'cause it was pretty shallow." At this point, Deputy Berg suggested that he be allowed to handle Canley's medical care. Matthews said, "Berg is an EMT and I work

13 DATE / TIME OF REPORT 02/01/07 1:26 PM	14 REPORTING OFFICER / ID NO / DIV / UNIT Detective R. Davidson #2775/Special Services	15 APPROVED BY / ID NO Sgt. W. J. [Signature] 3318
---	--	--

NARRATIVE REPORT VENTURA COUNTY SHERIFF'S DEPARTMENT

Page 10 of 16 Continuation

AGENCY IDENTIFIER CA0560000

1 RD 9072	2 BEAT 9G01	3 PB NUMBER 06-30492
--------------	----------------	-------------------------

4 CODE	5 ITEM	6 QTY	7 ITEM NAME	8 BRAND / MAKE MANUFACTURER	9 MODEL NAME OR NUMBER	10 MISC. DESCRIPTION	11 IDENTIFICATION / SERIAL NUMBER	12 VALUE
--------	--------	-------	-------------	-----------------------------	------------------------	----------------------	-----------------------------------	----------

with him at the Air Unit, so I know he is capable of doing it. And I said, 'It's probably a good idea.'

Detective Matthews said he walked with Deputy Hall to the west where the entrance to the parking area begins. Deputy Hall asked Matthews how big the Crime Scene needed to be. Detective Matthews said he helped place the crime scene tape around the area. Additional, patrol units began to arrive. Detective Matthews told the arriving deputies that [REDACTED] had seen the entire incident and he also mentioned the Hispanic man he had contacted earlier.

About ten minutes later, Detective Matthews was standing with Deputy Ferruzza, who had been assigned to stay with him, when he (Matthews) looked down and saw that his digital audio recorder was on and had been on during the entire incident. Detective Matthews looked at the recorder and saw that it had been running for, "50 something minutes." Matthews said he knew that this would include [REDACTED]'s interview and the shooting. Detective Matthews then said, "So I turned it off in front of Paul [Ferruzza], or I stopped the recording - I turned it off and I gave it to him and I told him, 'You better hold onto this, its got the whole shooting on the tape.'"

Detective Matthews said he then sat in the car and waited. Up until this point in the walk-through, I had asked very few questions. It was my intention to obtain Detective Matthews initial statement unfettered. I told Detective Matthews that I now wanted to walk him back through what he had said to ensure that I had a clear and accurate picture of what he had told us.

13. DATE / TIME OF REPORT 02/01/07 1:26 PM	14. REPORTING OFFICER / ID NO. / DIV / UNIT Detective R. Davidson#2775/Special Services	15. APPROVED BY / ID NO. SGT. W. J. [Signature] 7318
---	--	---

NARRATIVE REPORT VENTURA COUNTY SHERIFF'S DEPARTMENT

Page 11 of 16 Continuation

AGENCY IDENTIFIER CA0560000

1 RD 9072	2 BEAT 9G01	3 RB NUMBER 06-30492
--------------	----------------	-------------------------

4 CODE	5 ITEM	6 QTY	7 ITEM NAME	8 BRAND / MAKE MANUFACTURER	9 MODEL NAME OR NUMBER	10 MISC. DESCRIPTION	11 IDENTIFICATION / SERIAL NUMBER	12 VALUE
--------	--------	-------	-------------	-----------------------------	------------------------	----------------------	-----------------------------------	----------

I told Matthews that if I got anything wrong he was to correct me. I also told him I would now ask some probing questions about what he was experiencing as he went through the incident. Detective Matthews told me he understood.

I paraphrased Matthew's statement and as I reached portions of the incident, which I wanted to talk more about, I would stop and ask questions of Matthews.

The first question I asked Matthews was concerning the initial statements Canley made to him while he was talking to [REDACTED]. Matthews answered, "I remember that he thought [REDACTED] was a cop too, because he said, 'I know you - I know you guys are Sheriffs and you're not going to get me - or - you're not going to take me.' You know as I think back on it, it was almost challenging, like - 'cause he stood there for a few moments as if he wanted me to respond. And I didn't. I tur-I turned my back on him and went back to talking to [REDACTED], like I didn't want to address it right at that moment."

Matthews continued, "But when he returned then in my mind said, 'something - obviously something's not right this guy needs to be talked to and something - I mean to me - I mean I've had drug training, to me the guy was, was high on meth or coke or some kind of stimulant. Couldn't - you know he was pacing back and forth - he couldn't hold still. Honestly, he had that meth paranoia almost going. You know how they get, like everybody's after him. That's how it seemed like, he thought I was after him and yet, I didn't even know who the guy was."

13 DATE / TIME OF REPORT 02/01/07 1:26 PM	14 REPORTING OFFICER / ID NO. / DIV / UNIT Detective R. Davidson#2775/Special Services	15 APPROVED BY / ID NO. Sgt. W. J. [Signature] 3318
--	---	--

NARRATIVE REPORT VENTURA COUNTY SHERIFF'S DEPARTMENT

Page 12 of 16 Continuation

AGENCY IDENTIFIER CA0560000

1 RD 9072	2 BEAT 9G01	3 RB NUMBER 06-30492
--------------	----------------	-------------------------

4 CODE	5 ITEM	6 QTY	7 ITEM NAME	8 BRAND / MAKE MANUFACTURER	9 MODEL NAME OR NUMBER	10 MISC DESCRIPTION	11 IDENTIFICATION / SERIAL NUMBER	12 VALUE
--------	--------	-------	-------------	-----------------------------	------------------------	---------------------	-----------------------------------	----------

I then asked Detective Matthews to describe in more detail the portion of his statement where he is now chasing Canley and he (Canley) is fumbling with something in his waistband. I further asked Matthews to, "Tell me what you're thinking and what feeling as that is going on. What is your perception of what he's doing?"

Detective Matthews said, "As he's running, he's crouched over and he's reaching with both hands to his front, which I can't see. And he's already told me that I'm not going to take him, that I'm not going to take him alive, so I'm - I assume that he's going for a weapon. That's why I threw my notebook and pulled my gun out as soon as I started running; so that if he were to turn and have a weapon, I would already be up and on target to address that threat. But he never turned towards me and when his hands came out at the truck, I didn't see anything in them. I didn't remember seeing any keys."

Chronologically, we were at the point that Canley was getting into the truck. I asked Detective Matthews how far away he was from Canley as he was getting into the truck. Matthews estimated that he was about 15 feet away. Matthews added that he had not gained any ground on Canley as he chased after him. I then asked Matthews to tell me more about what took place when he arrived at the door and he had his gun pointed at Canley. Matthews said, "I'm yelling at him, Stop! Sheriff's Department, get out of the truck. Let me see your hands. Get out of the truck. Stop. Stop what you're doing." Matthews continued, "And he's yelling back at me, I can't remember specific words, but [pause] I want to say he - I, I can't remember what he was saying. I just

13 DATE / TIME OF REPORT 02/01/07 1:26 PM	14 REPORTING OFFICER / ID NO / DIV / UNIT Detective R. Davidson#2775/Special Services	15 APPROVED BY / ID NO <i>Sgt. W. J. [Signature]</i> 3318
--	--	--

NARRATIVE REPORT VENTURA COUNTY SHERIFF'S DEPARTMENT

Page 13 of 16 Continuation

AGENCY IDENTIFIER CA0560000

1 RD 9072	2 BEAT 9G01	3 RB NUMBER 06-30492
--------------	----------------	-------------------------

4 CODE	5 ITEM	6 QTY	7 ITEM NAME	8 BRAND / MAKE MANUFACTURER	9 MODEL NAME OR NUMBER	10 MISC DESCRIPTION	11 IDENTIFICATION / SERIAL NUMBER	12 VALUE
--------	--------	-------	-------------	-----------------------------	------------------------	---------------------	-----------------------------------	----------

remember that he was yelling at me and he was hitting at the window; like trying to keep me from grabbing onto the truck or from grabbing onto him."

I then prompted Matthews to continue by saying, "O.k., he then starts the car." Matthews kept talking saying, "He starts the car, I tried to break the window when he started the car. In my mind, I told myself there's no way he's driving away. Not in his condition. I mean he's - something - I mean he was high. For him to be driving that car around there's no way. So I just remember telling myself, don't let him leave in the truck - don't let him leave in the truck."

Matthews continued, "When I hit the window and it didn't break, I reached for the door and I tried to open the door and that's when he backed out. And I went with the truck - I can't remember if I held on or I just instinctively just followed it out, but when the truck came out, all of a sudden I'm standing in front of it. And I remember saying to myself, 'How did I end up in front of the truck.' I was at the side before and so I started - the whole time I'm yelling, 'Stop, Stop! Sheriff's Department. Stop what you're doing.' You know, and I started walking back, or I started back peddling." Later in the interview, Matthews said that during this time Canley was yelling something unintelligible at him.

I interjected, "Why are you back peddling? Let me ask you that." Matthews said, "Cause he's, he's got the truck started and coming after me. That's what I believe. He's starting to roll forward and he's revving the engine and so I, I don't know why I didn't

13 DATE / TIME OF REPORT 02/01/07 1:26 PM	14 REPORTING OFFICER / ID NO / DIV / UNIT Detective R. Davidson#2775/Special Services	15 APPROVED BY / ID NO <i>Sgt. W. J. [Signature]</i> 8318
--	--	--

NARRATIVE REPORT VENTURA COUNTY SHERIFF'S DEPARTMENT

Page 14 of 16 Continuation

AGENCY IDENTIFIER CA0560000

1 RD 9072	2 BEAT 9G01	3 RB NUMBER 06-30492
--------------	----------------	-------------------------

4 CODE	5 ITEM	6 QTY.	7 ITEM NAME	8 BRAND / MAKE MANUFACTURER	9 MODEL NAME OR NUMBER	10 MISC. DESCRIPTION	11 IDENTIFICATION / SERIAL NUMBER	12 VALUE
--------	--------	--------	-------------	-----------------------------	------------------------	----------------------	-----------------------------------	----------

side step. But I was back peddling and I fired two rounds at the truck. I remember staring at the grill and seeing the grill break apart and then the screeching of tires and thinking that he was gonna run me over and that I needed to shoot him in the head, where I could see. I remember saying to myself, shoot what you could see, and all I could see was his head barely over the dash. So I remember I was right on his, where his head was and I fired. I thought it was two rounds, but after counting the rounds at the station it turned out to be three."

I then said, "Tell me, as you're hearing screeches and he's starting to come forward, what - what are you feeling at that point?" Detective Matthews answered, "I'm thinking, I'm gonna get run over. This guys gonna run me over, he's in a big truck and he's gonna do anything he can to get away. And uhm, I, I still remember being in disbelief that I was in front of the truck, cause I couldn't figure out how I got there. But all I knew was that I was there and I was back peddling; and I fired the first two rounds I saw them hit the grill and I told myself that didn't do anything. And I came up to where his head was when he was still coming forward - I remember saying 'stop' really loud a couple of times after the first two rounds, and then, and then he - I remember tires screeching and him coming at me. I fired the three rounds and peeled off and side stepped and then at that point, his foot was definitely off the gas and he just coasted to where the truck is now. He wasn't going at any speed."

I then asked Detective Matthews about the clothing he was wearing when the incident took place. I looked at Matthew's apparel and

13 DATE / TIME OF REPORT 02/01/07 1:26 PM	14 REPORTING OFFICER / ID NO / DIV / UNIT Detective R. Davidson#2775/Special Services	15 APPROVED BY / ID NO <i>Sgt. W. J. Ayers</i> 2318
--	--	--

NARRATIVE REPORT VENTURA COUNTY SHERIFF'S DEPARTMENT

Page 15 of 16 Continuation

AGENCY IDENTIFIER CA0560000

1 RD 9072	2 BEAT 9G01	3 RB NUMBER 06-30492
--------------	----------------	-------------------------

4 CODE	5 ITEM	6 QTY.	7 ITEM NAME	8 BRAND / MAKE MANUFACTURER	9 MODEL NAME OR NUMBER	10 MISC. DESCRIPTION	11 IDENTIFICATION / SERIAL NUMBER	12 VALUE
--------	--------	--------	-------------	-----------------------------	------------------------	----------------------	-----------------------------------	----------

described it for the tape. Matthews was wearing a blue button front shirt, tie, slacks and a belt. Attached to his belt was Matthew's badge, gun/holster and handcuffs (in back). Also, around Matthew's neck on a lanyard was his department issued identification card. Matthews commented that except for a jacket, which I had given him to wear (it was after midnight and cold), he was dressed the same as when the incident took place. I asked Detective Matthews if he noticed anything on Canley's person when he was confronting him at the driver's door and/or look for anything on him after pulling him from the vehicle. Matthews said he saw a lighter hanging out of Canley's right pocket, which he pulled out and put on the ground. Matthews then said, "I felt his sweatshirt pockets and in there I found a cell phone. I reached into his left pocket and found 2 black gloves, one of which I believe had a crank pipe in it. I never saw the crank pipe, but I could feel it. I set it aside. I reached under his back as far as I could, but I didn't get all the way. But I couldn't feel anything under his - in the belt line under his back. And his arms, the sleeves of the sweatshirt, but that's about all I - that's all I patted down, just those general areas real quick. And, quite honestly, I wasn't concerned that he was faking, 'cause he had that - his color was fading, his eyes were starting to roll back and I could see his hands clearly; there was nothing in his hands." I interjected, "At that point he wasn't a threat to you." Matthews agreed and added, "Right, I wasn't thinkin' you know - continue searching. It was more to provide some help."

I confirmed there was no one else with Canley at any time during the incident. Matthews said there was not and the only people he

13 DATE / TIME OF REPORT 02/01/07 1:26 PM	14 REPORTING OFFICER / ID NO / DIV / UNIT Detective R. Davidson#2775/Special Services	15 APPROVED BY / ID NO SGT. W. J. [Signature] 3318
--	--	---

NARRATIVE REPORT VENTURA COUNTY SHERIFF'S DEPARTMENT

Page 16 of 16 Continuation

AGENCY IDENTIFIER CA0560000

1 RD 9072	2 BEAT 9G01	3 RD NUMBER 06-30492
--------------	----------------	-------------------------

4 CODE	5 ITEM	6 QTY	7 ITEM NAME	8 BRAND / MAKE MANUFACTURER	9 MODEL NAME OR NUMBER	10 MISC. DESCRIPTION	11 IDENTIFICATION / SERIAL NUMBER	12 VALUE
--------	--------	-------	-------------	-----------------------------	------------------------	----------------------	-----------------------------------	----------

was aware of in the area were Canley, [REDACTED] and himself. Matthews then said that he had no idea where the Hispanic male was during the incident or where he came from.

I told Detective Matthews that I had a good sense of what took place. I asked the other people in attendance if they would like to route a question to Detective Matthews through me; no one had any additional questions. I explained to Detective Matthews that if I had any follow-up questions for him I would direct them to him through his attorney. I then concluded the interview at 0039 hrs.

End of report.

13 DATE / TIME OF REPORT 02/01/07 1:26 PM	14 REPORTING OFFICER / ID NO / DIV / UNIT Detective R. Davidson#2775/Special Services	15 APPROVED BY / ID NO SGT. W. J. [Signature] 3318
--	--	---

NARRATIVE REPORT VENTURA COUNTY SHERIFF'S DEPARTMENT

Page 2 of 6 Continuation

AGENCY IDENTIFIER CA0560000

1 RD 9072	2 BEAT 9G01	3 RB NUMBER 2006-30492
--------------	----------------	---------------------------

4 CODE	5 ITEM	6 QTY	7 ITEM NAME	8 BRAND / MAKE MANUFACTURER	9 MODEL NAME OR NUMBER	10 MISC. DESCRIPTION	11 IDENTIFICATION / SERIAL NUMBER	12 VALUE
--------	--------	-------	-------------	-----------------------------	------------------------	----------------------	-----------------------------------	----------

████████ confirmed that on the evening of November 14, 2006, he was working at Station 31 as a Firefighter / Paramedic. He confirmed that on the evening of November 14, 2006, he responded to call of a gunshot victim at ██████████ in the City of Thousand Oaks.

████████ was assigned to Squad 31 as the driver. Also assigned to Squad 31 were Firefighter / Paramedic ██████████ and Fire Cadet ██████████.

████████ and the fire personnel from Station 31 were at the scene of a traffic collision on the northbound 101 Freeway south of Hampshire Road when the call for the gunshot victim was received. He said the call was received at approximately 1800 hours. The dispatcher asked if the fire personnel from Station 31 were available for another call in their sector. The dispatcher was advised that the fire personnel from Station 31 were available to respond.

████████ explained that the fire personnel from Station 31 changed radio channels and were dispatched to the call of the gunshot victim. He explained that initially Engine 31 cancelled their response because Medic Engine 34 was closer to the call of the gunshot victim. ██████████ continued that Engine 31, Squad 31, and Medic Engine 34 all responded to the scene and staged at Conejo School Road and Los Feliz Drive (until cleared to enter the scene by the Sheriff's Department). He estimated it took approximately 10 seconds to arrive at the staging location because he and the other fire personnel in Squad 31 were on their way to Station 31.

████████ said he called Fire Dispatch and was told that Squad 31 was cleared to enter the scene of the gunshot victim at 1816 hours or 1817 hours.

████████ confirmed that he drove Squad 31 to the scene of the gunshot victim. The scene was located within an apartment complex. ██████████ explained that he parked Squad 31 between two Sheriff's Department vehicles in front of the crime scene tape.

Upon arrival, a Deputy Sheriff met ██████████ and he asked the Deputy Sheriff if the gunshot victim was alive. The Deputy Sheriff confirmed that the gunshot victim was alive. ██████████ explained that he retrieved the medical equipment from Squad 31 and approached the gunshot victim. He said Senior Deputy Berg was attending to the gunshot victim.

13 DATE / TIME OF REPORT 11/22/06/ 8:09 AM	14 REPORTING OFFICER / ID NO / SN / UNIT Det. S. Peterson #2238 / Spl. Svcs. <i>SP</i>	15 APPROVED BY / ID NO Sgt. Ayub #3318 <i>SA</i>
---	---	---

NARRATIVE REPORT VENTURA COUNTY SHERIFF'S DEPARTMENT

Page 3 of 6

Continuation

AGENCY IDENTIFIER CA0560000

1 PD 9072	2 SEAT 9G01	3 PD NUMBER 2006-30492
--------------	----------------	---------------------------

4 CODE	5 ITEM	6 QTY	7 ITEM NAME	8 BRAND / MAKE MANUFACTURER	9 MODEL NAME OR NUMBER	10 MISC. DESCRIPTION	11 IDENTIFICATION / SERIAL NUMBER	12 VALUE
--------	--------	-------	-------------	-----------------------------	------------------------	----------------------	-----------------------------------	----------

████████ said the gunshot victim was lying "supine (on his back)" with his "face up," his head pointed toward Squad 31, and his feet were pointed toward a gray truck. He believed the gunshot victim was wearing a white shirt, possibly a T-shirt, black jeans, and black "Converse" shoes. When he initially saw the gunshot victim, ██████████ saw blood coming out of the gunshot victim's right chest area.

Senior Deputy Berg told ██████████ that the gunshot victim had a pulse and was breathing. ██████████ saw that an "emergency kit" used by the Sheriff's Department was open and it appeared that the "mouth to mask" was on the ground. He continued that Senior Deputy Berg was beginning to perform some kind of treatment to the gunshot victim before his arrival.

████████ explained that he was at the scene of the gunshot victim approximately 20 to 30 seconds before the arrival of an Engine. He continued that Senior Deputy Berg asked what he could do assist him. ██████████ said he gave Senior Deputy Berg a pair of "trauma shears" and told him to cut the gunshot victim's shirt off. He continued to explain the treatment he and Firefighter / Paramedic ██████████ provided the gunshot victim.

████████ explained that the gunshot victim was only taking two to four breaths a minute. He heard the Engine arriving at the scene and yelled to the fire personnel on the Engine that he needed a backboard and assistance with the gunshot victim. ██████████ explained that Firefighter / Emergency Medical Technician ██████████ began providing oxygen to the gunshot victim while he prepared the intubation equipment.

████████ explained that he inserted an airway into the gunshot victim and added that the gunshot victim did not have a gag reflex. He explained that as he prepared the intubation equipment he provided instructions to Firefighter / Paramedic ██████████ and the other emergency personnel. ██████████ explained that he intubated the gunshot victim and placed an endotracheal tube into the gunshot victim's trachea to control the airway. He continued to explain the other medical procedures performed on the gunshot victim.

13 DATE / TIME OF REPORT 11/22/06/ 8:09 AM	14 REPORTING OFFICER / ID NO / DIV / UNIT Det. S. Peterson #2238 / Spl. Svcs.	15 APPROVED BY / ID NO Sgt. Ayub #3318
---	--	---

NARRATIVE REPORT VENTURA COUNTY SHERIFF'S DEPARTMENT

Page 4 of 6 Continuation

AGENCY IDENTIFIER CA0560000

1 RD 9072	2 BEAT 9G01	3 RB NUMBER 2006-30492
--------------	----------------	---------------------------

4 CODE	5 ITEM	6 QTY	7 ITEM NAME	8 BRAND / MAKE MANUFACTURER	9 MODEL NAME OR NUMBER	10 MISC. DESCRIPTION	11 IDENTIFICATION / SERIAL NUMBER	12 VALUE
--------	--------	-------	-------------	-----------------------------	------------------------	----------------------	-----------------------------------	----------

████████ said a cervical collar was placed on the gunshot victim's neck and he continued to explain the other medical procedures performed on the gunshot victim. Once the medical procedures were complete, ██████████ stood up to make sure everything was "going good." He continued that the ambulance arrived at the scene and the ambulance personnel assisted in inserting an "IV" into the left side of the gunshot victim while Firefighter / Paramedic ██████████ inserted an "IV" into the gunshot victim's right side.

████████ continued that he stood up and verbalized that the gunshot victim's pants needed to be "cut off." He then went to Squad 31 to retrieve the equipment needed to contact Los Robles Regional Medical Center to advise them of the incident. ██████████ said he cut the gunshot victim's pants off. He explained that after he went to Squad 31 he returned to the gunshot victim and saw that the gunshot victim pants had not been cut off. ██████████ said he obtained a pair of "shears" and cut the gunshot victim's pants and began "ripping" them off.

████████ said he began to cut the gunshot victim's pants on the right leg and ripped the pants up the leg from the cuff to the gunshot victim's waist. He did the same to the gunshot victim's left pant leg and could see the gunshot victim's underwear. ██████████ said he did not see a gun at that time because he was looking for blood in the gunshot victim's pants. He described the gun as being "camouflaged" with the gunshot victim's pants.

████████ explained that as he putting the "shears" away he and Firefighter / Paramedic ██████████ looked down and saw the gun. He corrected himself and stated that he actually cut the left leg of the gunshot victim's pants before the right leg. ██████████ said the gun was "leaning" next to the gunshot victim's "crotch" and right thigh. He confirmed that the gun was between the gunshot victim's legs and was closer to his right thigh. ██████████ explained that the way the gunshot victim's pants had been cut, the cut resembled a "seam" and the gun was lying next to the seam. The gun barrel was pointed toward the gunshot victim's feet and the "handle" was toward the gunshot victim's groin.

13 DATE / TIME OF REPORT 11/22/06/ 8:09 AM	14 REPORTING OFFICER / ID NO / DIV / UNIT Det. S. Peterson #2238 / Spl. Svcs.	15 APPROVED BY / SIGNATURE Sgt. Ayub #3318
---	--	---

NARRATIVE REPORT VENTURA COUNTY SHERIFF'S DEPARTMENT

Page 5 of 6 Continuation

AGENCY IDENTIFIER CA0560000

1 RD 9072	2 BEAT 9G01	3 RB NUMBER 2006-30492
--------------	----------------	---------------------------

4 CODE	5 ITEM	6 QTY	7 ITEM NAME	8 BRAND / MAKE MANUFACTURER	9 MODEL NAME OR NUMBER	10 MISC. DESCRIPTION	11 IDENTIFICATION / SERIAL NUMBER	12 VALUE
--------	--------	-------	-------------	-----------------------------	------------------------	----------------------	-----------------------------------	----------

██████████ said the gun was a black "handgun." I showed him my department issued semiautomatic gun. ██████████ said the gunshot victim's gun looked like my semiautomatic gun. He did not know if the gun was ready to be fired or if the slide was locked back (not ready to be fired).

After ██████████ saw the gun he told Senior Deputy Berg there was a gun on the person of the gunshot victim. Senior Deputy Berg said not to touch or move the gun, and he was putting on gloves to possibly secure the gun. ██████████ continued that it appeared that Firefighter / Paramedic ██████████ pushed the gun away toward the lower portion of the gunshot victim's legs or foot. He continued that at the same time the gunshot victim was being prepared to be placed on a backboard. ██████████ said the gunshot victim was successfully placed onto the backboard and then onto a gurney.

██████████ explained that the gunshot victim was secured onto the backboard and then he went to the ambulance to prepare for the transportation of the gunshot victim. Within 20 seconds, the gunshot victim was brought to the ambulance.

██████████ said he and Firefighter / Paramedic ██████████ responded to the Emergency Room at Los Robles Regional Medical Center in the back of the ambulance with the gunshot victim. They were with Paramedic ██████████. ██████████ said the ambulance responded to the Emergency Room with the use of its lights and siren (Code 3).

██████████ said the gunshot victim never regained consciousness at the scene and he never made any statements. He said the gunshot victim did not regain consciousness while being transported in the ambulance and he never made any statements.

While enroute to the Emergency Room, the gunshot victim maintained a pulse and blood pressure. However, the gunshot victim did experience respiratory arrest.

13 DATE / TIME OF REPORT 11/22/06/ 8:09 AM	14 REPORTING OFFICER / ID NO / DIV / UNIT Det. S. Peterson #2238 / Spl. Svcs.	15 APPROVED BY / ID NO Sgt. Ayub #3318
---	--	---

NARRATIVE REPORT VENTURA COUNTY SHERIFF'S DEPARTMENT

Page 6 of 6 Continuation

AGENCY IDENTIFIER CA0560000

1 RD 9072	2 BEAT 9G01	3 RB NUMBER 2006-30492
--------------	----------------	---------------------------

4 CODE	5 ITEM	6 QTY	7 ITEM NAME	8 BRAND / MAKE MANUFACTURER	9 MODEL NAME OR NUMBER	10 MISC. DESCRIPTION	11 IDENTIFICATION / SERIAL NUMBER	12 VALUE
--------	--------	-------	-------------	-----------------------------	------------------------	----------------------	-----------------------------------	----------

I asked [REDACTED] if he saw a wound on the gunshot victim's shoulder after the gunshot victim's shirt had been removed. He explained that he did and the wound was above the gunshot victim's right clavicle. [REDACTED] did not see any other wounds on the gunshot victim's body. He explained how the gunshot victim's back was checked for injuries after the gunshot victim was rolled onto his right side. [REDACTED] said as the gunshot victim's back was being checked for injury, it was at that time that he saw the gunshot victim had a "piece" missing from his left thumb. He stated that it appeared the gunshot victim's thumb had "been possibly shot by a gun." [REDACTED] described the wound to the gunshot victim's left thumb as the tip being "amputated pretty much."

[REDACTED] explained that upon arrival to the Emergency Room, the medical personnel at the Emergency Room took over the gunshot victim's medical treatment. He attempted to explain to me which room the gunshot victim was placed into upon arrival to the Emergency Room. A nurse who was in the room while I interviewed [REDACTED] said the gunshot victim had been placed into Room 6 of the Emergency Room.

I asked [REDACTED] if he had any additional information to add to this interview. He explained that he placed a petroleum based dressing over the gunshot wound on the gunshot victim. [REDACTED] explained that he placed the dressing on the gunshot victim at the scene before he went to prepare the ambulance to transport the gunshot victim to the Emergency Room.

[REDACTED] had no additional information to add to this interview.

End of report.

13 DATE / TIME OF REPORT 11/22/06/ 8:09 AM	14 REPORTING OFFICER / ID NO / DIV / UNIT Det. S. Peterson #2238 / Spl. Svcs.	15 APPROVED BY / ID NO Sgt. Ayub #3318
---	--	---

NARRATIVE REPORT VENTURA COUNTY SHERIFF'S DEPARTMENT

Page 1 of 5 Continuation

AGENCY IDENTIFIER CA0560000

1 RD 9072	2 BEAT 9G01	3 RB NUMBER 2006-30492
--------------	----------------	---------------------------

4 CODE	5 ITEM	6 QTY.	7 ITEM NAME	8 BRAND / MAKE MANUFACTURER	9 MODEL NAME OR NUMBER	10 MISC DESCRIPTION	11 IDENTIFICATION / SERIAL NUMBER	12 VALUE
--------	--------	--------	-------------	-----------------------------	------------------------	---------------------	-----------------------------------	----------

Supplemental Case Cleared

Gang Domestic Hate Child Abuse Elderly Abuse

Connecting Report Numbers:

Code Section / Description: Officer Involved Shooting

Reclassify To:

Code: P Name: Canley, Adrian Doyle

Witness Interview

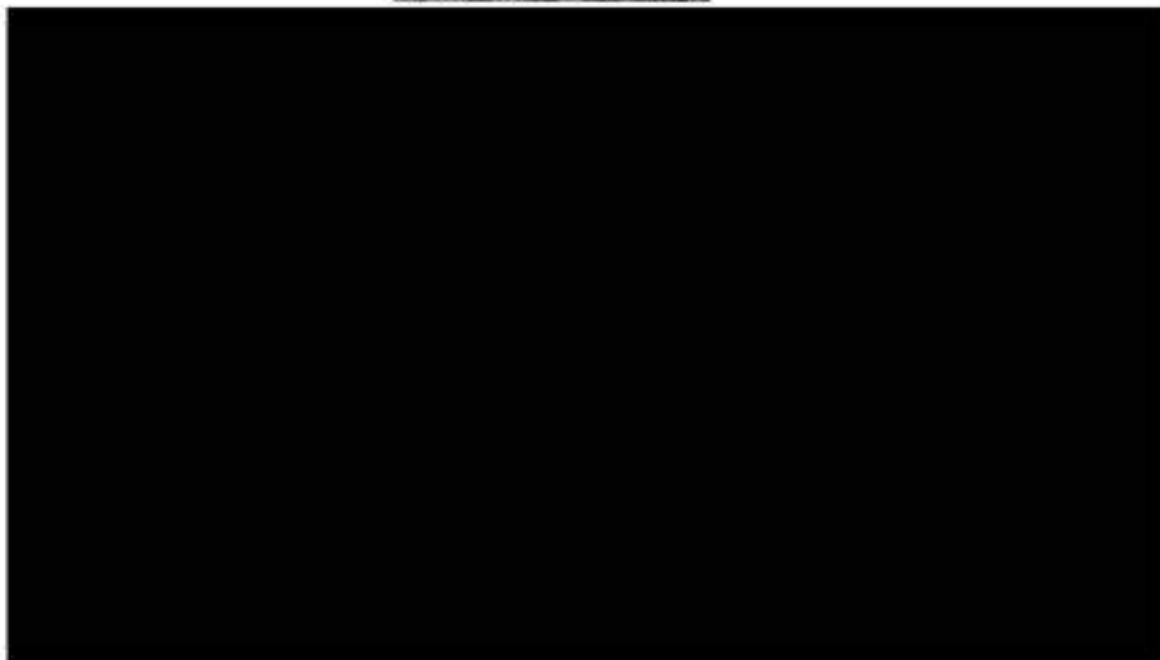

On November 14, 2006, at approximately 1958 hours, I interviewed Emergency Medical Technician [REDACTED], employed by American Medical Response (ambulance company), in the Nurses Lounge at Los Robles Regional Medical Center in the City of Thousand Oaks. This interview was digitally recorded. The following is a summary of the interview. Refer to the CD ROM containing the recording for additional information:

13 DATE / TIME OF REPORT 11/20/06/ 7:55 PM	14 REPORTING OFFICER / ID NO / DIV / UNIT Det. S. Peterson #2238 / Spl. Svcs. <i>SP</i>	15 APPROVED BY / ID NO Sgt. Ayu5 #3318 <i>BA</i>
---	--	---

NARRATIVE REPORT VENTURA COUNTY SHERIFF'S DEPARTMENT

Page 2 of 5 Continuation

AGENCY IDENTIFIER CA0560000

1 RD 9072	2 BEAT 9G01	3 RB NUMBER 2006-30492
--------------	----------------	---------------------------

4 CODE	5 ITEM	6 QTY.	7 ITEM NAME	8 BRAND / MAKE MANUFACTURER	9 MODEL NAME OR NUMBER	10 MISC. DESCRIPTION	11 IDENTIFICATION / SERIAL NUMBER	12 VALUE
--------	--------	--------	-------------	-----------------------------	------------------------	----------------------	-----------------------------------	----------

██████████ confirmed that on the evening of November 14, 2006, he responded to a call of a gunshot victim at ██████████ in the City of Thousand Oaks. He was working with Paramedic ██████████. They were assigned as unit "452." ██████████ was driving the ambulance and ██████████ was the passenger.

██████████ could not remember the time he and ██████████ received the call of the gunshot victim. They were at "Borders (a bookstore)" in the City of Thousand Oaks when the call was received over their portable radio. The dispatcher advised the address of the call and stated the call concerned a victim with a gunshot wound. ██████████ explained that he only heard that Squad 31, from the Ventura County Fire Department, was also responding to the call.

██████████ confirmed that he and ██████████ responded to the call. ██████████ was driving the ambulance and he was the passenger. He explained that he used a map to guide ██████████ to the location of the call, and he told me the route they drove to the call. ██████████ estimated they arrived at the scene of the call within four to five minutes.

Upon arrival to the scene, ██████████ saw "activity" taking place on the right side of the ambulance near a white truck. ██████████ parked the ambulance near the scene behind a marked Sheriff's Department patrol vehicle. ██████████ said the scene was located in the parking lot area of an apartment complex near a "main driveway."

██████████ continued and said he saw "activity" taking place on the left side of the ambulance near a white truck. He saw personnel from the Ventura County Fire Department providing treatment to a "patient" lying on his back on the ground. ██████████ explained that the gunshot victim's head was pointed in a west or southwest direction. He believed Firefighter / Paramedic ██████████, assigned to Squad 31, was in the process of intubating the gunshot victim and cardiopulmonary resuscitation was not taking place. ██████████ said he was told the gunshot victim had a pulse and blood pressure.

13 DATE / TIME OF REPORT 11/20/06/ 7:55 PM	14 REPORTING OFFICER / ID NO / DIV / UNIT Det. S. Peterson #2238 / Spl. Svcs. <i>SP</i>	15 APPROVED BY / ID NO Sgt. Ayub #3318 <i>BA</i>
---	--	---

NARRATIVE REPORT VENTURA COUNTY SHERIFF'S DEPARTMENT

Page 3 of 5 Continuation

AGENCY IDENTIFIER CA0560000

1 RD 9072	2 BEAT 9G01	3 RB NUMBER 2006-30492
--------------	----------------	---------------------------

4 CODE	5 ITEM	6 QTY.	7 ITEM NAME	8 BRAND / MAKE MANUFACTURER	9 MODEL NAME OR NUMBER	10 MISC. DESCRIPTION	11 IDENTIFICATION / SERIAL NUMBER	12 VALUE
--------	--------	--------	-------------	-----------------------------	------------------------	----------------------	-----------------------------------	----------

██████████ said the gunshot victim was not wearing a shirt and his pants had been cut open from his legs to his waist. He continued that the gunshot victim appeared to be a male, approximately 30 years of age or in his early thirties. ██████████ said the gunshot victim was approximately 5 feet 7 inches tall, approximately 150 pounds in weight, and had tattoos from his neck to his waist. He did not notice if the gunshot victim was wearing any footwear.

██████████ said there were enough emergency personnel treating the gunshot victim and he did not want to get involved and make the situation more crowded than it was. He explained that ██████████ approached the gunshot victim's left side and attempted to insert an "IV." ██████████ explained that he stood approximately 5 to 6 feet away from the gunshot victim's head.

██████████ said ██████████ was attempting to insert an "IV" in the gunshot victim's left arm while another Paramedic was attempting to insert an "IV" into the right arm. He continued that Firefighter / Paramedic ██████████ completed the intubation of the gunshot victim and secured the intubation tube. ██████████ saw one gunshot wound on the upper right chest area below the clavicle of the gunshot victim. He said there was "minor" bleeding around the wound. ██████████ said the gunshot victim was unconscious and unresponsive, but his eyes were open and he was not moving.

██████████ continued to explain that the "IV" on the gunshot victim's left arm was completed, but not on his right arm. Once the "IV's" were completed, an unknown person placed a cervical collar around the gunshot victim's neck. ██████████ explained that he was preparing a backboard and "head bed" to secure the gunshot victim's head to the backboard. He continued that once the "IV's" were established the other emergency personnel wanted to quickly move the gunshot victim.

██████████ continued that the gunshot victim was rolled onto his right side and he heard the other emergency personnel state that the gunshot victim did not have any visible wounds on his back. He explained that the gunshot victim was rolled back onto his back and the process of

13 DATE / TIME OF REPORT 11/20/06/ 7:55 PM	14 REPORTING OFFICER / ID NO / DIV / UNIT Det. S. Peterson #2238 / Spl. Svcs.	15 APPROVED BY / ID NO Sgt. Ayub #3318
---	--	---

NARRATIVE REPORT VENTURA COUNTY SHERIFF'S DEPARTMENT

Page 4 of 5 Continuation

AGENCY IDENTIFIER CA0560000

1 RD 9072	2 BEAT 9G01	3 RB NUMBER 2006-30492
--------------	----------------	---------------------------

4 CODE	5 ITEM	6 QTY.	7 ITEM NAME	8 BRAND / MAKE MANUFACTURER	9 MODEL NAME OR NUMBER	10 MSC. DESCRIPTION	11 IDENTIFICATION / SERIAL NUMBER	12 VALUE
--------	--------	--------	-------------	-----------------------------	------------------------	---------------------	-----------------------------------	----------

placing him on the backboard began. [REDACTED] explained that he secured the gunshot victim's head onto the backboard and the remainder of his body was also secured to the backboard. Once the gunshot victim was secured to the backboard, [REDACTED] stepped back and assisted with placing the gunshot victim onto the gurney. He explained how the Firefighters lifted the backboard containing the gunshot victim onto the gurney.

I told [REDACTED] when I interviewed [REDACTED] she told me at one point the gunshot victim's pants were being moved. I continued that when the gunshot victim's pants were moved "something" was seen. I asked [REDACTED] if he remembered that. He said, "I absolutely remember that." [REDACTED] explained that he handed [REDACTED] his "trauma shears" and she began to make "further" cuts to the gunshot victim's pants before he was placed on the backboard and after the "IV" had been established.

[REDACTED] said [REDACTED] finished cutting off the gunshot victim's pants so she could "visualize" the gunshot victim's pelvis and upper legs. He explained that at some point someone saw the "weapon" and said, "Deputy, there's a weapon here. It's down here." [REDACTED] looked and saw what appeared to be a "Glock semiautomatic black pistol." He said the gun was in a firing position (the slide was not locked back). [REDACTED] said the gun was by the gunshot victim's right leg. He said it appeared to him that the gun was in the "middle of the cut open pants" and he was not certain how the gun got there. [REDACTED] explained that he did not see the gun at the same time as the fire personnel. He clarified that the gun was on the right side of the gunshot victim's right leg, and he believed the gun's grip was facing upward toward the gunshot victim's head. [REDACTED] said the gun was "pointing outward from the body." He clarified that the "muzzle" of the gun was pointed out away from the gunshot victim's leg.

After seeing the gun, [REDACTED] made room for the Deputy Sheriff to secure it. He said he did not see the Deputy Sheriff secure the gun because he was preparing the backboard.

[REDACTED] explained that he believed the Deputy Sheriff secured the gun and removed it from the area of the gunshot victim's body.

13 DATE / TIME OF REPORT 11/20/06/ 7:55 PM	14 REPORTING OFFICER / ID NO / DIV / UNIT Det. S. Peterson #2238 / Spl. Svcs.	15 APPROVED BY / ID NO Sgt. Ayub #3318
---	--	---

NARRATIVE REPORT VENTURA COUNTY SHERIFF'S DEPARTMENT

Page 5 of 5 Continuation

AGENCY IDENTIFIER CA0560000

1 RD 9072	2 BEAT 9G01	3 RB NUMBER 2006-30492
--------------	----------------	---------------------------

4 CODE	5 ITEM	6 QTY	7 ITEM NAME	8 BRAND / MAKE MANUFACTURER	9 MODEL NAME OR NUMBER	10 MISC. DESCRIPTION	11 IDENTIFICATION / SERIAL NUMBER	12 VALUE
--------	--------	-------	-------------	-----------------------------	------------------------	----------------------	-----------------------------------	----------

██████████ confirmed that the gunshot victim was placed inside the ambulance after he was secured onto the backboard and the gurney. He said he drove the ambulance utilizing the emergency lights and siren (Code 3) during the transportation of the gunshot victim to the Emergency Room at Los Robles Regional Medical Center. ██████████, Firefighter / Paramedic ██████████, and a Firefighter / Paramedic named Jeff treated the gunshot victim in the ambulance on the way to the medical center.

██████████ said at the scene the gunshot victim never regained consciousness. He did not believe that the gunshot victim regained consciousness during the transport to the medical center. At no time did the gunshot victim make any statements.

██████████ explained what occurred when he and the other emergency personnel arrived at the medical center and the medical center staff took over treatment of the gunshot victim.

I asked ██████████ if he remembered any additional information I had not asked him about. He said he remembered that it was "mentioned" that there were four gunshots. ██████████ continued that he was told that two shots struck the gunshot victim, one to the right shoulder or upper chest and one to an unknown finger. He said ██████████ or one of the Firefighter / Paramedics provided him that information as they entered the Emergency Room. ██████████ then clarified that he believed ██████████ provided him the information.

██████████ had no additional information to add to this interview.

End of report.

13 DATE / TIME OF REPORT 11/20/06/ 7:55 PM	14 REPORTING OFFICER / ID NO / DIV / UNIT Det. S. Peterson #2238 / Spl. Svcs.	15 APPROVED BY / ID NO Sgt. Ayub #3318
---	--	---

NARRATIVE REPORT VENTURA COUNTY SHERIFF'S DEPARTMENT

Page 4 of 7

Continuation

AGENCY IDENTIFIER CA0560000

1 RD	2 BEAT	3 FB NUMBER
9072	9G01	2006-30492

4 CODE	5 ITEM	6 QTY	7 ITEM NAME	8 BRAND / MAKE MANUFACTURER	9 MODEL NAME OR NUMBER	10 MISC. DESCRIPTION	11 IDENTIFICATION / SERIAL NUMBER	12 VALUE
--------	--------	-------	-------------	-----------------------------	------------------------	----------------------	-----------------------------------	----------

Supplemental Case Cleared

Gang Domestic Hate Child Abuse Elderly Abuse

Connecting Report Numbers:

Code Section / Description: Officer Involved Shooting

Reclassify To:

Code: P Name: Canley, Adrian Doyle

Witness Interview

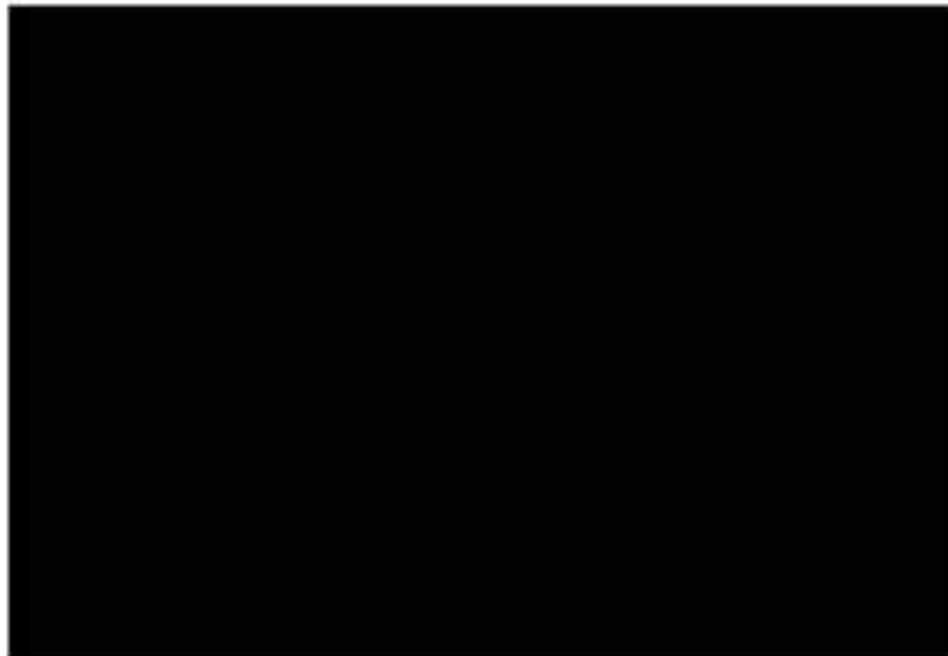

On November 14, 2006, at approximately 2119 hours, I interviewed Firefighter / Paramedic [REDACTED] employed by the Ventura County Fire Department, in the Nurses Lounge at Los Robles Regional Medical Center in the City of Thousand Oaks. This interview was digitally recorded. The following is a summary of the interview. Refer to the CD ROM containing the recording for additional information:

13 DATE / TIME OF REPORT 11/27/06/ 9:10 AM	14 REPORTING OFFICER / ID NO / DIV / UNIT Det. S. Peterson #2238 / Spl. Svcs.	15 APPROVED BY / ID NO Sgt. Ayub #3318
---	--	---

NARRATIVE REPORT VENTURA COUNTY SHERIFF'S DEPARTMENT

Page 2 of 7 Continuation

AGENCY IDENTIFIER CA0560000

1 RD	2 BEAT	3 RB NUMBER
9072	9G01	2006-30492



4 CODE	5 ITEM	6 QTY	7 ITEM NAME	8 BRAND / MAKE MANUFACTURER	9 MODEL NAME OR NUMBER	10 MISC. DESCRIPTION	11 IDENTIFICATION / SERIAL NUMBER	12 VALUE
--------	--------	-------	-------------	-----------------------------	------------------------	----------------------	-----------------------------------	----------

█████ confirmed that on November 14, 2006, he was working at Station 31 as a Firefighter / Paramedic. He confirmed that on November 14, 2006, he responded to a call of a gunshot victim at ██████ in the City of Thousand Oaks. ██████ was assigned to Squad 31 with Firefighter / Paramedic ██████ and Fire Cadet ██████. Firefighter / Paramedic ██████ was assigned as the driver and ██████ was assigned as the "attendant."

█████ explained that he and the other fire personnel from Station 31 were at the scene of a traffic collision on the northbound 101 Freeway south of Hampshire Road when the call of the gunshot victim was received. The dispatcher advised the address where the gunshot victim was located ██████. The dispatcher further advised that the fire personnel were to stage for the arrival of law enforcement to the scene. ██████ confirmed that he, Firefighter / Paramedic ██████ and Fire Cadet ██████ responded to the scene of the gunshot victim from the scene of the traffic collision. He estimated it took approximately five minutes to arrive at the staging area. ██████ said he and the other fire personnel remained at the staging area for approximately one minute before being cleared to enter the scene where the gunshot victim was located.

█████ described the location of the scene as being within "some type of an apartment complex" or "condominium complex." He said Firefighter / Paramedic ██████ parked Squad 31 approximately 40 feet away from the gunshot victim with the squad's headlights facing the gunshot victim in an "eastbound direction."

Upon arrival to the scene, ██████ advised the dispatcher that Squad 31 had arrived at the scene. He exited Squad 31 and retrieved medical equipment from the Squad. ██████ also directed Fire Cadet ██████ to retrieve some additional medical equipment from the Squad. He said he then walked over to the gunshot victim. ██████ said the gunshot victim was an approximate 28-year-old male with breathing respirations that were not sufficient enough to maintain his life. He added that the gunshot victim was taking one breath approximately every five seconds. ██████ said the gunshot victim was "gasping for a breath."

13 DATE / TIME OF REPORT	14 REPORTING OFFICER / ID NO / DIV / UNIT	15 APPROVED BY / ID NO
11/27/06/ 9:10 AM	Det. S. Peterson #2238 / Spl. Svcs. 	Sgt. Ayub #3318 

NARRATIVE REPORT VENTURA COUNTY SHERIFF'S DEPARTMENT

Page 3 of 7

Continuation

AGENCY IDENTIFIER CA0560000

1 RD	2 BEAT	3 RB NUMBER
9072	9G01	2006-30492

4 CODE	5 ITEM	6 QTY.	7 ITEM NAME	8 BRAND / MAKE MANUFACTURER	9 MODEL NAME OR NUMBER	10 MISC. DESCRIPTION	11 IDENTIFICATION / SERIAL NUMBER	12 VALUE
--------	--------	--------	-------------	-----------------------------	------------------------	----------------------	-----------------------------------	----------

█████ said the gunshot victim was lying "supine (on his back)" and his extremities were "basically sprawled out." He believed the gunshot victim was wearing black jeans. █████ explained that when he arrived the gunshot victim's chest was exposed. He continued that it appeared that the gunshot victim was wearing a "sweatshirt" and possibly a "couple layers of shirts." █████ said the sweatshirt and layers of shirts on the gunshot victim were "already open." He believed that the sweatshirt and layers of shirts had been pulled up as opposed to being cut off.

█████ said the gunshot victim's sweatshirt was possibly black in color. The gunshot victim's other shirts were possibly white and gray in color. █████ could not recall if the gunshot victim was wearing any footwear. He did not see anything around the gunshot victim's body.

█████ confirmed that he saw an injury on the gunshot victim. He saw an "entry wound" on the gunshot victims' upper right chest that appeared to be below the clavicle. █████ believed the gunshot victim was not wearing the sweatshirt or layers of shirts when he initially saw the gunshot wound. He added that when he initially walked up to the gunshot victim he "clearly" saw the gunshot wound.

█████ explained the medical treatment that he and Firefighter / Paramedic █████ performed on the gunshot victim. He was on the gunshot victim's right side performing medical treatment. █████ believed there was a truck behind him that narrowed the space between him and the gunshot victim.

█████ said after he performed his initial medical treatment on the gunshot victim, he directed a uniformed Deputy Sheriff to cut off the gunshot victim's clothing. He clarified that he told the Deputy Sheriff to cut off all the clothing on the gunshot victim from his torso toward his head. █████ continued to explain the medical treatment and results that he performed on the gunshot victim. He continued that the Deputy Sheriff cut off "all" the gunshot victim's clothing. █████ clarified that the Deputy Sheriff only cut off the gunshot victim's sweatshirt and layers of shirts.

13 DATE / TIME OF REPORT	14 REPORTING OFFICER / ID NO. / DIV / UNIT	15 APPROVED BY / ID NO.
11/27/06/ 9:10 AM	Det. S. Peterson #2238 / Spl. Svcs. <i>SP</i>	<i>BA</i> Sgt. Ayub #3318

NARRATIVE REPORT VENTURA COUNTY SHERIFF'S DEPARTMENT

Page 4 of 7 Continuation

AGENCY IDENTIFIER CA0560000

1 RD	2 BEAT	3 FB NUMBER
9072	9G01	2006-30492

4 CODE	5 ITEM	6 QTY	7 ITEM NAME	8 BRAND / MAKE MANUFACTURER	9 MODEL NAME OR NUMBER	10 MISC. DESCRIPTION	11 IDENTIFICATION / SERIAL NUMBER	12 VALUE
--------	--------	-------	-------------	-----------------------------	------------------------	----------------------	-----------------------------------	----------

He added that he assisted the Deputy Sheriff in cutting off the gunshot victim's upper clothing in a "cut, tear, rip operation."

██████ confirmed that he had a better view of the gunshot victim's gunshot wound after the gunshot victim's sweatshirt and layers of shirts had been removed. He said he was initially told that four shots had been fired at the scene. ██████ said the information he heard about the numbers of shots that had been fired was more "hearsay" rather than being directed to him by a specific person. He confirmed that the amount of shots that had been fired was one of the topics being discussed at the scene.

██████ said "initially" the entry of the gunshot wound was not "too hard to see." He continued that the clothing had been cut off the gunshot victim's upper torso so the gunshot victim could be checked for additional gunshot wounds. ██████ said the clothing from the gunshot victim's upper torso was lying on the ground under the gunshot victim's back, and he pulled the clothing out from under the gunshot victim.

██████ said the emergency personnel from "AMR (American Medical Response ambulance company)" arrived at the scene and he saw Paramedic ██████. He said Paramedic ██████ asked him what she could do. ██████ continued that he placed a tourniquet on the gunshot victim's right upper arm and asked Paramedic ██████ to establish an "IV" into the gunshot victim's left arm. He continued to explain the difficulties in establishing an "IV" into the gunshot victim's right arm. ██████ said that the gunshot victim's arms appeared to have "some type of what we refer to as track marks or scars." He clarified that the track marks or scars were on the gunshot victim's right arm. ██████ continued that he was unable to establish the "IV."

██████ said Firefighter / Paramedic ██████ intubated the gunshot victim. He continued to tell me about the medical treatment he provided to the gunshot victim after the gunshot victim was intubated. ██████ said he then directed "people" that he needed to have the gunshot victim's pants cut off because that was a "main priority." He said "a few minutes" passed before the gunshot victim's pants were cut off, and he believed Firefighter / Paramedic ██████ was the

13 DATE / TIME OF REPORT	14 REPORTING OFFICER / ID NO / DIV / UNIT	15 APPROVED BY / ID NO
11/27/06/ 9:10 AM	Det. S. Peterson #2238 / Spl. Svcs.	Sgt. Ayub #3318 <i>BA</i>

NARRATIVE REPORT VENTURA COUNTY SHERIFF'S DEPARTMENT

Page 5 of 7 Continuation

AGENCY IDENTIFIER CA0560000

1 RD 9072	2 BEAT 9G01	3 RB NUMBER 2006-30492
--------------	----------------	---------------------------

4 CODE	5 ITEM	6 QTY	7 ITEM NAME	8 BRAND / MAKE MANUFACTURER	9 MODEL NAME OR NUMBER	10 MISC. DESCRIPTION	11 IDENTIFICATION / SERIAL NUMBER	12 VALUE
--------	--------	-------	-------------	-----------------------------	------------------------	----------------------	-----------------------------------	----------

person who cut off the gunshot victim's pants. ██████ said Firefighter / Paramedic ██████ began the cuts at the cuffs of the gunshot victim's pants and went up both legs of the pants to the "belt region, pelvic region."

██████ said the gunshot victim's pants were opened after being cut. A search began to determine if the gunshot victim had more gunshot wounds on his lower body and none were found. ██████ said at that point the gunshot victim was about to be moved from the ground to a backboard. He added that it was during that time that he saw the gun. ██████ said the gun was on top of the gunshot victim's pants in the area of the gunshot victim's "genital area." He said the barrel of the gun was pointed toward the gunshot victim's left leg.

I asked ██████ to describe the gun. He indicated he could not describe it. I showed ██████ my department issued semiautomatic gun. He said the gun was a "good sized handgun." ██████ said the gun was "very" similar to my department issued semiautomatic gun. He said the gun was black in color and was in a position that it could be fired (the slide of the gun was not locked back). ██████ continued that the gun was pointed toward the gunshot victim's left thigh. He said he remembered that because Paramedic ██████ was on the gunshot victim's left side.

██████ said he let "everyone" know that a gun was present. He said the same Deputy Sheriff who cut the gunshot victim's sweatshirt and layer of shirts noticed the gun. ██████ said, "And for some reason I -- I don't know if it was shot right away, but my intention was to get that patient on the backboard." I asked him what he meant when he said "shot right away." He explained that he was referring to a photograph being taken of the gun were it was found on the gunshot victim's person. ██████ explained that he was confused because he believed someone was going to retrieve a camera to photograph the gun.

██████ continued that he moved the gunshot victim's pants because the gunshot victim had to have his clothing removed in order to be rolled over to check for additional gunshot wounds or injuries. He said the gunshot victim was rolled onto his right side. No additional wounds were found on the gunshot victim's back or other parts of his body.

13 DATE / TIME OF REPORT 11/27/06/ 9:10 AM	14 REPORTING OFFICER / ID NO / DIV / UNIT Det. S. Peterson #2238 / Spl. Svcs.	15 APPROVED BY / ID NO BA Sgt. Ayub #3318
---	--	---

NARRATIVE REPORT VENTURA COUNTY SHERIFF'S DEPARTMENT

Page 6 of 7 Continuation

AGENCY IDENTIFIER CA0560000

1 RD 9072	2 BEAT 9G01	3 RB NUMBER 2006-30492
--------------	----------------	---------------------------

4 CODE	5 ITEM	6 QTY	7 ITEM NAME	8 BRAND/ MAKE MANUFACTURER	9 MODEL NAME OR NUMBER	10 MISC DESCRIPTION	11 IDENTIFICATION/ SERIAL NUMBER	12 VALUE
--------	--------	-------	-------------	----------------------------	------------------------	---------------------	----------------------------------	----------

█████ said the gun had not been retrieved at the point the gunshot victim was rolled onto his side to check for additional gunshot wounds or injuries. He continued that he had to pull the gunshot victim's pants out from underneath the gunshot victim, and the gun came out with the pants. █████ explained that he did not touch the gun and that he moved the gun on the gunshot victim's pants in order to transport the gunshot victim for medical treatment. He continued that he moved the gunshot victim's pants toward the gunshot victim's feet and the gun came with the pants. █████ reiterated that he did not touch the gun. He said he folded the gunshot victim's pants over the top of the gun. █████ said "someone" said the gun should be seen, so he opened the pants to expose the gun. He confirmed that he never touched the gun, but it was possible that he might have "scraped" against it.

█████ said the gunshot victim was then placed onto a backboard and explained how that was completed. Once the gunshot victim was secured to the backboard he was then secured onto a gurney. █████ confirmed that the gunshot victim was then moved to the ambulance.

█████ said he went in the ambulance to transport the gunshot victim to the Emergency Room at Los Robles Regional Medical Center. Firefighter / Paramedic █████ and Paramedic █████ were with him in the back of the ambulance treating the gunshot victim while the ambulance was driven by an unknown person from the ambulance company. █████ estimated that it took approximately 7 to 8 minutes to get from the scene to the Emergency Room. He said the ambulance was driven to the Emergency Room with the use of the ambulance's emergency lights and siren (Code 3).

█████ said the gunshot victim never regained consciousness or made any statements at the scene or in the ambulance. At no time during the drive to the Emergency Room did the gunshot victim stop having a heart rate or pulse.

█████ explained that upon arrival to the Emergency Room the gunshot victim was placed inside Room 6 of the Emergency Room. He continued that the gunshot victim then began to

13 DATE / TIME OF REPORT 11/27/06/ 9:10 AM	14 REPORTING OFFICER / ID NO. / DIV / UNIT Det. S. Peterson #2238 / Spl. Svcs.	15 APPROVED BY / ID NO. Sgt. Ayub #3318
---	---	--

NARRATIVE REPORT VENTURA COUNTY SHERIFF'S DEPARTMENT

Page 7 of 7 Continuation

AGENCY IDENTIFIER CA0560000

1 RD 9072	2 BEAT 9G01	3 RB NUMBER 2006-30492
---------------------	-----------------------	----------------------------------

4 CODE	5 ITEM	6 QTY	7 ITEM NAME	8 BRAND / MAKE MANUFACTURER	9 MODEL NAME OR NUMBER	10 MISC. DESCRIPTION	11 IDENTIFICATION / SERIAL NUMBER	12 VALUE
--------	--------	-------	-------------	-----------------------------	------------------------	----------------------	-----------------------------------	----------

receive medical treatment from the medical staff at the Emergency Room. [REDACTED] said he remained in the area to assist the medical staff with the gunshot victim's medical treatment.

I asked [REDACTED] if he had any additional information to add to this interview. He explained that on the drive to the Emergency Room he attempt to establish another "IV" into the gunshot victim without success.

[REDACTED] had no additional information to add to this interview.

End of report.

13 DATE / TIME OF REPORT 11/27/06/ 9:10 AM	14 REPORTING OFFICER / ID NO. / DIV / UNIT Det. S. Peterson #2238 / Spl. Svcs.	15 APPROVED BY / ID NO. <i>SP</i> Sgt. Ayub #3318
--	--	--

NARRATIVE REPORT VENTURA COUNTY SHERIFF'S DEPARTMENT

Page 1 of 2 Continuation

AGENCY IDENTIFIER CA0560000

1 RD 9072	2 BEAT 9G01	3 RB NUMBER 2006-30492
--------------	----------------	---------------------------

4 CODE	5 ITEM	6 QTY	7 ITEM NAME	8 BRAND / MAKE MANUFACTURER	9 MODEL NAME OR NUMBER	10 MISC DESCRIPTION	11 IDENTIFICATION / SERIAL NUMBER	12 VALUE
--------	--------	-------	-------------	-----------------------------	------------------------	---------------------	-----------------------------------	----------

- Supplemental Case Cleared
 Gang Domestic Hate Child Abuse Elderly Abuse

Connecting Report Numbers:

Code Section / Description: 245(c) P.C.

Reclassify to:

Code: S-1 Name: Canley, Adrian



On 11/14/06, at approximately 1840 hours, I arrived at [REDACTED], Thousand Oaks, Ca. I had information that this was the scene of a shooting between Detective Matthews and (S) Adrian Canley. I was asked by Sergeant Powers to interview the firefighters that were still on scene.

I directed the Fire personnel to move their engine out of the crime scene and across Los Feliz Drive to an adjacent driveway. I then interviewed each of the Fire personnel separately. I spoke to Fire Cadet [REDACTED] [REDACTED], and digitally recorded our interview. [REDACTED] said he is currently assigned to Station # 31, located at 151 Duesenberg Drive, Thousand Oaks, Ca. Refer to the CD, and my Supplemental reports for further details.

[REDACTED] said they were dispatched to a gunshot victim (S – Canley) at a location on Los Feliz Drive. Once on scene, he helped get a backboard from the engine and brought it to the paramedics. He then helped with retrieving other items needed to assist with treating (S) Canley. [REDACTED] said Canley was on the ground next to a white truck.

I then asked [REDACTED] if he could see any injuries on Canley's body. [REDACTED] said he could see a wound in the upper right portion of Canley's chest, near his shoulder. He also commented that

13 DATE / TIME OF REPORT 11-24-06 / 1007	14 REPORTING OFFICER / ID NO / DIV / UNIT Det. J. Smith/#2569/East County M.C.	15 APPROVED BY / ID NO <i>[Signature]</i> / 2486
---	---	---

NARRATIVE REPORT VENTURA COUNTY SHERIFF'S DEPARTMENT

Page 2 of 2 Continuation

AGENCY IDENTIFIER CA0560000

1 RD 9072	2 BEAT 9G01	3 RB NUMBER 2006-30492
--------------	----------------	---------------------------

4 CODE	5 ITEM	6 QTY.	7 ITEM NAME	8 BRAND / MAKE MANUFACTURER	9 MODEL NAME OR NUMBER	10 MISC. DESCRIPTION	11 IDENTIFICATION / SERIAL NUMBER	12 VALUE
--------	--------	--------	-------------	-----------------------------	------------------------	----------------------	-----------------------------------	----------

Canley had a lot of tattoos on his torso. [REDACTED] said as the paramedics were cutting open Canley's pants, a gun was discovered inside the right side of Canley's pants. I asked [REDACTED] if he could describe Canley's condition, and he said Canley was unresponsive. [REDACTED] said he remained on scene after the paramedics transported Canley.

I asked [REDACTED] if he noticed anything unusual about the white truck next to Canley. At first, [REDACTED] said he did not notice anything. A few seconds later, [REDACTED] said the truck was leaking what he believed to be coolant.

End of Interview.

13 DATE / TIME OF REPORT 11-24-06 / 1007	14 REPORTING OFFICER / IDNO / DIV / UNIT Det. J. Smith/#2569/East County M.C.	15 APPROVED BY / IDNO <i>J. Smith</i> / 2486
---	--	---

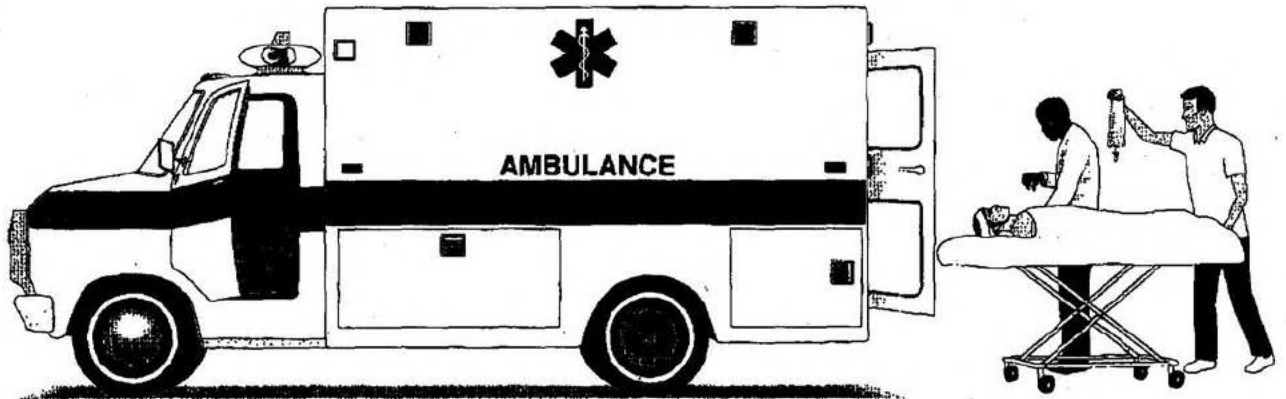

AMR

FAX COVER SHEET

FROM: Bonnie Smith

PHONE# 310-851-7600 ext. 12054

FAX # 310-851-7705

TO: BILL AYUB

PHONE _____

DATE: 1/3/2007

FAX # 805-477-7010

COMMENTS:	
GOOD MORNING BILL ATTACHED YOU WILL FIND TRIP NOTES FOR PATIENT ADRIAN CANLEY	
HOPEFULLY THIS INFORMATION IS READABLE AND HELPFUL IF MORE INFORMATION IS NEEDED	
PLEASE FEEL FREE TO CONTACT ME AND ABOVE NUMBER	

Number of pages 9 including cover sheet.

AMERICAN MEDICAL RESPONSE
 20101 Hamilton Ave. Suite 300
 Torrance, CA. 90502

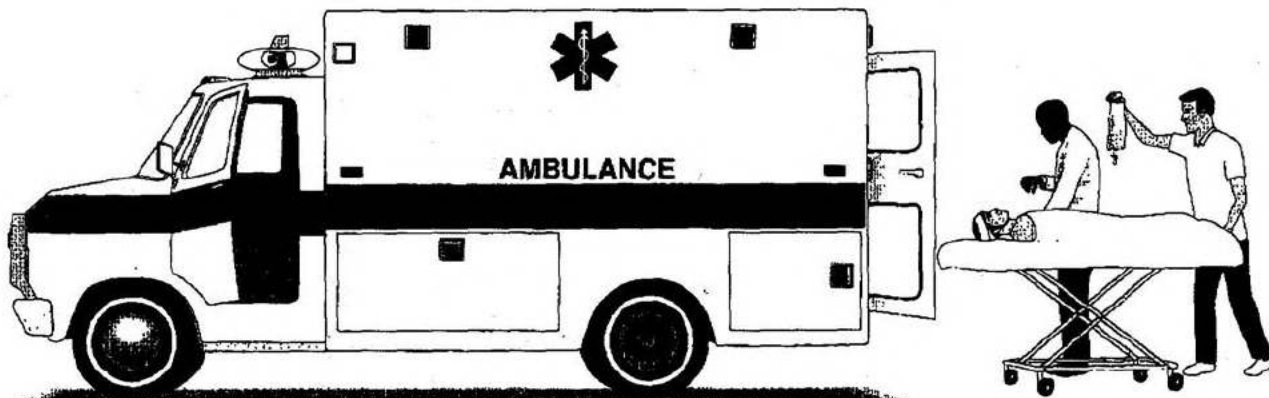

AMR

FAX COVER SHEET

FROM: Bonnie Smith

PHONE# 310-851-7600 ext. 12054

FAX # 310-851-7705

TO: BILL AYUB

PHONE _____

DATE: 1/3/2007

FAX # 805-477-7010

COMMENTS:

GOOD MORNING BILL ATTACHED YOU WILL FIND TRIP NOTES FOR PATIENT ADRIAN CANLEY
 HOPEFULLY THIS INFORMATION IS READABLE AND HELPFUL IF MORE INFORMATION IS NEEDED
 PLEASE FEEL FREE TO CONTACT ME AND ABOVE NUMBER

Number of pages 9 including cover sheet.

AMERICAN MEDICAL RESPONSE
 20101 Hamilton Ave. Suite 300
 Torrance, CA. 90502

MED452

11/14/2006

AMR Ventura
Ventura County Fire

Run #
Fire Incident #
Priority:
Call Type:
InitBy:
Location:
City:
MapGrid:

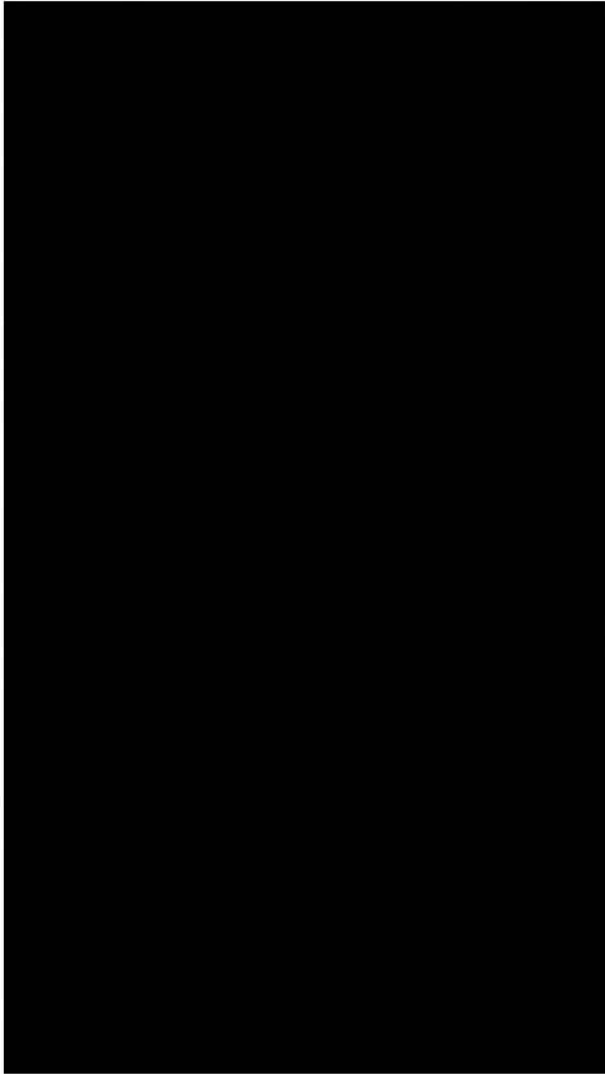

Received:
Dispatched:
Enroute:
OnScene:
Transport:
Arrival:
Available:
Cancel Time:

11/15/2006 8:33:51 AM
79 OF 107



American Medical Response Ventura County Division

Divisional Offices: 616 Fitch Avenue Moorpark, CA 93021

Billing office: 20101 Hamilton Ave. Suite 300 Torrance, CA 90502 (310) 851-7000

INCIDENT INFORMATION

AMR ACCT # (OFFICE USE ONLY)	DATE OF SERVICE	CURRENT DATE AND TIME			
	2006/11/14	11/14/2006 9:26 PM			
INCIDENT # <input checked="" type="checkbox"/> COUNTY FIRE <input type="checkbox"/> AMR	UNIT#	PICKUP ADDRESS	CITY	STATE	ZIP
6101562	9452		T.O.	CA	91360
		DESTINATION	ROOM #		
		LRH&MC	ER6		

PATIENT INFORMATION

LAST NAME	FIRST NAME	MI	
CANLEY	ADRIAN	D	GCS 3

INSURANCE

PRIMARY INS. <input type="checkbox"/> WORK RELATED <input type="checkbox"/> T.C.	POLICY #	GROUP #	PHONE #
MEDICAL	556839935		() -
SECOND INS. <input checked="" type="checkbox"/> NA <input type="checkbox"/> WORK RELATED <input type="checkbox"/> T.C.	POLICY #	GROUP #	PHONE #
			() -

GUARANTOR SAME AS PATIENT NOT WORK RELATED

LAST NAME	FIRST NAME	MI	
STREET ADDRESS	APT/SUITE	PHONE #	RELATIONSHIP
		(805) -	SELF
CITY	STATE	ZIP	
EMPLOYER	ADDRESS	CITY	STATE ZIP
UNK			

EMPLOYEE 1: NAME O'BRIEN, HEATHER ID# 202484 EMPLOYEE 2: SIMPSON, CHRIS ID# 200546 PT # 1 OF 1

LEVEL OF SERVICE TRANSPORT SUPPLIES AND EQUIPMENT

<input type="checkbox"/> BLS BASE RATE	<input checked="" type="checkbox"/> ALS AIRWAY	<input checked="" type="checkbox"/> O ₂ @ 15LPM NRB <input checked="" type="checkbox"/> Nc <input type="checkbox"/> Hc <input type="checkbox"/> AM	MILES WITH TENTHS	
<input checked="" type="checkbox"/> EMERGENCY RESPONSE	<input checked="" type="checkbox"/> AMBU BAG	<input type="checkbox"/> SPLINT	START	FINISH
<input type="checkbox"/> IMMEDIATE RESPONSE	<input type="checkbox"/> SUCTION EQUIP.	<input type="checkbox"/> BURN KIT	22.3	29.6
<input type="checkbox"/> BH CONTACT/ MONITOR ONLY	<input checked="" type="checkbox"/> BACKBOARD	<input type="checkbox"/> COLD PACKS	DESTINATION	
<input type="checkbox"/> MULTIPLE PATIENTS	<input checked="" type="checkbox"/> C-SPINE IMMOB.	<input type="checkbox"/> OBSTETRICS KIT	<input checked="" type="checkbox"/> CLOSEST FACILITY	
<input checked="" type="checkbox"/> ALS BASE RATE	<input checked="" type="checkbox"/> C-COLLAR	<input type="checkbox"/> RESTRAINTS-VIOLENT	<input type="checkbox"/> DIVERSION	
<input checked="" type="checkbox"/> REGULATORY COMPLIANCE	<input type="checkbox"/> KED	<input type="checkbox"/> RESTRAINTS-NON VIOLENT	<input type="checkbox"/> HMO/PT REQUEST	
<input checked="" type="checkbox"/> ADDL. MEDICAL PERSONNEL	<input type="checkbox"/> TRACTION SPLINT	<input checked="" type="checkbox"/> INFECTION CONTROL	<input type="checkbox"/> MD REQUEST	
<input type="checkbox"/> NEONATAL TEAM TRANSPORT	<input checked="" type="checkbox"/> DRESSING	<input checked="" type="checkbox"/> DISPOSABLE LINEN		

INTERFACILITY TRANSFER CODES-CHECK ALL THAT APPLY

<input type="checkbox"/> 01	HIGHER LEVEL OF CARE / SERVICES NOT AVAILABLE AT SENDING FACILITY
<input type="checkbox"/> 02	MD OR FAMILY REQUEST
<input type="checkbox"/> 03	INSURANCE REASON / NO CONTRACT FACILITY

MEDICAL NECESSITY CODES-CHECK ALL THAT APPLY

<input checked="" type="checkbox"/> 00	EMERGENCY (ACCIDENT, INJURY OR ACUTE ILLNESS)
<input type="checkbox"/> 01	NEEDED TO BE RESTRAINED
<input checked="" type="checkbox"/> 02	WAS/S UNCONSCIOUS AND/OR IN SHOCK
<input checked="" type="checkbox"/> 03	REQUIRED OXYGEN OR OTHER EMERGENCY TREATMENT/MONITORING
<input checked="" type="checkbox"/> 04	REMAIN IMMOBILE (SUSPECTED FRACTURE THAT HAS NOT BEEN SET)
<input type="checkbox"/> 05	SUSTAIN SUSPECTED ACUTE CVA OR MI
<input checked="" type="checkbox"/> 06	SEVERE HEMORRHAGE
<input type="checkbox"/> 07	BED CONFINED BEFORE /AFTER AMBULANCE TRIP (DOCUMENT REASON IN NARRATIVE)
<input checked="" type="checkbox"/> 08	COULD ONLY BE MOVED BY STRETCHER (DOCUMENT REASON IN NARRATIVE)
<input type="checkbox"/> 09	DID NOT NEED AMBULANCE TRANSPORT (DOCUMENT IN NARRATIVE AND HAVE RELEASE/AMA SIGNED)

DOCUMENTATION FOR GENERATION OF DRY RUN ACCOUNT

<input type="checkbox"/> 01	ALS SERVICES RENDERED INCLUDING MEDICATIONS
<input type="checkbox"/> 02	PATIENT TRANSPORT BY COUNTY HELICOPTER
<input type="checkbox"/> 03	PATIENT TRANSPORTED BY HELICOPTER WITH AMR PROVIDER ON BOARD

PATIENT IN CUSTODY OF LAW ENFORCEMENT AGENCY

LAW ENFORCEMENT AGENCY:	OFFICER:	ID/BADGE:
REASON IN CUSTODY:		

HIM Unit #

HIM Acct #

Patient
CANLEY,ADRIAN

Med. Rec/Unit #
G000460003

Service/Location
EMERGENCY RO

Status
REG ER

Date
11/14/06

Account #
G00209543570

PATIENT EMPLOYER

NONE- NOT EMPLOYED
UNK
UNK,CA XXXXX

Work Phone: (999)999-9999
Occupation: NONE

GUARANTOR EMPLOYER

NONE- NOT EMPLOYED
UNK
UNK,CA XXXXX

Work Phone: (999)999-9999
Occupation: NONE

OTHER GUARANTOR EMPLOYER

Address:

Home Ph: County:

Work Phone:
Occupation:

Relationship to Patient:
PERSON TO NOTIFY

NEXT OF KIN

Home Ph:
Relationship to Patient:

Work Ph:

Home Ph:
Relationship to Patient:

Work Ph:

INSURANCE #1
PEND MEDI-CAL VENDOR 03434

Policy #:556839935
Coverage #:
Subscriber: CANLEY,ADRIAN
Rel to Pt: PATIENT
Eff: to Rel Y Assign Y
Group: -NONE- NOT EMPLOYED

AUTHORIZATION

Treat/Precert: Not Required
Ins Verif: Not Required
Pro Review: Not Required
PA Code: 03434

Phone:

INSURANCE #2
CHARITY PENDING 09950
SELF PAY

Policy #:556839935
Coverage #:
Subscriber: CANLEY,ADRIAN
Rel to Pt: PATIENT
Eff: to Rel Y Assign Y
Group: -NONE- NOT EMPLOYED

AUTHORIZATION

Treat/Precert: Not Required
Ins Verif: Not Required
Pro Review: Not Required
PA Code: 09950

Phone:

OCCURRENCES

Code Type
05 OTHER ACCIDENT

Date Time
11/14/06 1853

CONDITIONS

Code Type

Special Program

OB/Type of Delivery

Last Hospitalization

Admission Comment
SEE NOTES

Financial Class
99

ADMISSION / REGISTRATION

Attending Physician

Admitting Physician

Emergency Room Physician
LR Emergency Phys

Prim Care Physician

Family Physician

Other Physician

ADMISSION / REGISTRATION

Date	Time	Source	Adm. Priority	Rm/Bed	Arrival	Admitting Diagnosis/Reason for Visit	Admitted By
11/14/06	1853	PR	EM	/	AMB	GUNSHOT WOUND	GADMJG

ADMISSION FORM

Los Robles Regional Medical Center
215 West Janss Road Thousand Oaks, CA 91380

Printed 11/14/06 2014



Acct:





- [Medi-Cal Home](#)
- [Transaction Login](#)
- [System Status](#)
- [POS System Status](#)
- [Education & Outreach](#)
- [Provider Bulletins](#)
- [Provider Manuals](#)
- [Fraud and Abuse](#)
- [Billing Tips Updated](#)
- [Contact Us](#)

- ▶ [Eligibility](#)
 - ◆ [Single Subscriber](#)
 - ◆ [Multiple Subscribers](#)
- ▶ [SOC \(Spend Down\)](#)
- ▶ [Medical Services Reservation](#)
- ▶ [TAR Menu](#)
- ▶ [eTAR Medical Tutorials](#)
- ▶ [Provider Services](#)
- ▶ [Pharmacy Online TAR](#)
- ▶ [eTAR Pharmacy Tutorial](#)
- ▶ [Batch Internet Eligibility](#)
- ▶ [Batch Claim Status](#)
- ▶ [Login](#)
- ▶ [Exit](#)

Eligibility Response

My CA

Eligibility transaction performed by provider: ZZZ315452
on Friday, November 17, 2006 at 12:19:51 PM



Subscriber ID:			556839935		
Service Date:	Subscriber Birth Date:	Issue Date:			
11/15/2006	04/01/1981	11/17/2006			
Primary Aid Code:		First Special Aid Code:			
Second Special Aid Code:		Third Special Aid Code:			
Subscriber County:		HIC Number:			
Primary Care Physician Phone #:		Service Type:			
Trace Number (Eligibility Verification Confirmation (EVC) Number):					
Eligibility Message: NO RECORDED ELIGIBILITY FOR 11/06.					



[Conditions of Use](#) [Privacy Policy](#)

Server:www.medi-cal.ca.gov |File:/Eligibility/EligResp.asp |Last Modified:2/17/2004 1:32:40 PM

Fire Incident #: C2006101562

Patient #: 1 of 1

Patient: CANLEY, ADRIAN DOYLE

Page: 1

VENTURA COUNTY EMERGENCY MEDICAL SERVICES PREHOSPITAL CARE RECORD

Complete

INCIDENT INFORMATION

Date: 11/14/2006
 Location Type: Residence
 Fire Incident #: C2006101562
 Agency Patient #: 6101562

Call Type: Emergency
 Care Level: ALS

Times
 911:
 Dispatch: 18:23:00
 Arrival: 18:30:00
 At Patient (Est):
 Base Hosp. Contact: 18:40:00
 Transport: 18:41:00
 At Destination: 18:49:00

Last Updated: 11/14/2006 9:52:00PM
 By: Obrien, [REDACTED]

Patient Conditions
 (Other)

[REDACTED]

T.O.

Actual Address:

PROVIDER INFORMATION

First Responder: V Cnty Sheriff
 EMT1/P
 Obrien, [REDACTED]
 other agency personnel, ALS
 [REDACTED], Christopher

Paramedic Agency: AMR

Cert.
 ALS
 ALS
 BLS

Transport Provider: AMR
 Unit: 452
 Vehicle Type: Ground

PATIENT INFORMATION

[REDACTED]

Gender: M
 Name: CANLEY, ADRIAN DOYLE

Medical History
 (Unknown)

[REDACTED]

NARRATIVE

[REDACTED]

Fire Incident #: C2006101562

Patient #: 1 of 1

Patient: CANLEY, ADRIAN DOYLE

Page: 2

ASSESSMENT

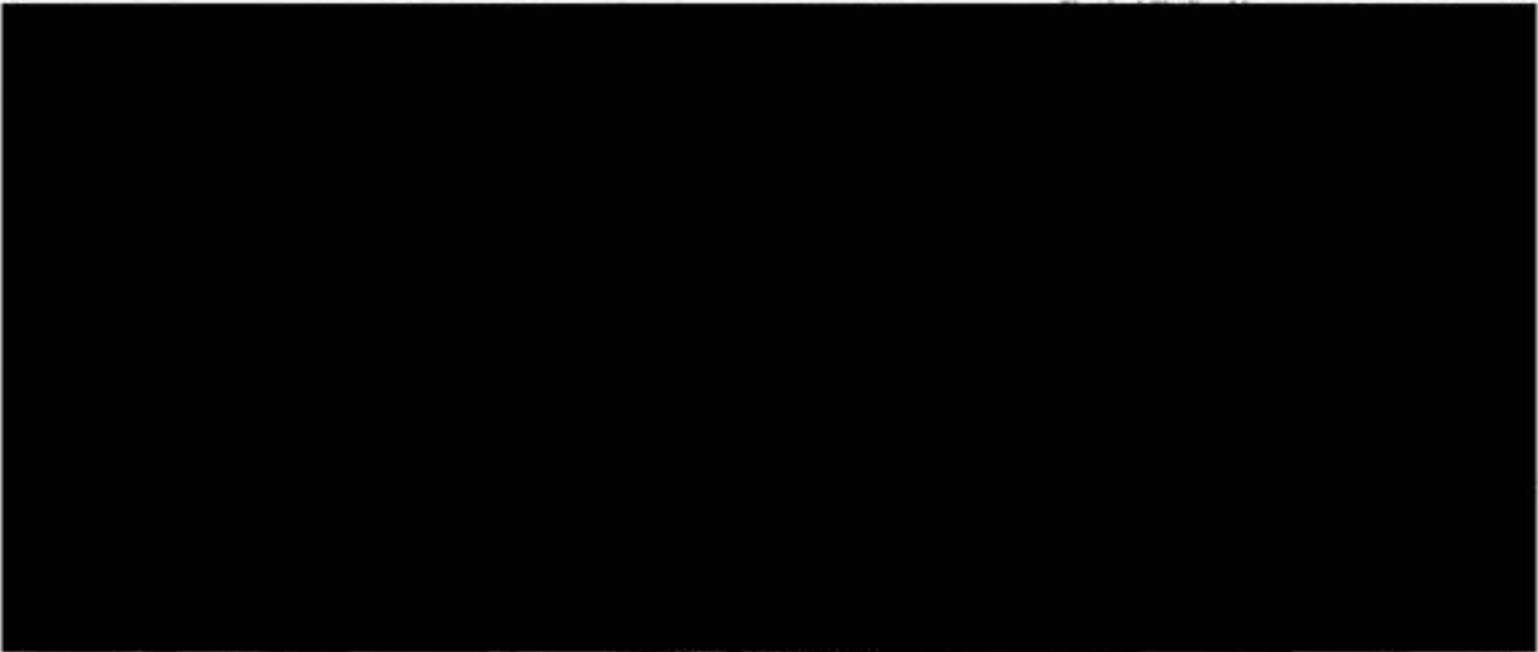

DISPOSITION

Base Hospital: LRRMC	Transported to: LRRMC	Final Disposition: Hospital, ED
Medical Control: Contact made, no orders given	Destination Decision: Most Accessible	Condition on Arrival: Unchanged

AMERICAN MEDICAL RESPONSE

We believe that for the services provided to you or about to be provided to you by this ambulance company, Medicare is likely to deny payment for the following services:

FOR THE FOLLOWING REASONS:

Therefore, we are required to give you this notice advising you that in the event Medicare denies payment, you will be responsible for payment. Please read the statement below, sign it, and return it to us.

CONDITIONS OF AMBULANCE SERVICE

The undersigned consents to ambulance transportation by American Medical Response (AMR). The undersigned also consents to the performance of medical services, administration of medications and all other emergency procedures consistent with local medical and hospital protocols, or as may be deemed appropriate and necessary according to instructions issued by the attending base station physician or other physician assuming responsibility for the care and treatment of the patient.

I hereby acknowledge services rendered to me or my dependents. I authorize use of this original, or a copy, and permit payment for same via assignment of medical insurance benefits to AMR or it's agents for this or any services provided to me by AMR. I authorize any holder of medical information or documentation about me to release it to the Health Care Finance Administration and it's agents or any other insurance agencies as well as to AMR any information or documentation needed to determine benefits payable for this service or any services provided to me by AMR now, or in the future.

The undersigned certifies that he/she has read the foregoing, and is the patient, the patient's legal representative, or is duly authorized by the patient as the patient's general agent to execute this consent and accept its terms.

In addition, I acknowledge that I was provided with, or a reasonable attempt was made to provide me with, a copy of American Medical Response's Notice of Privacy Practices and my rights in accordance with the Health Insurance Portability and Accountability Act of 1996, also known as HIPAA.

X BENEFICIARY SIGNATURE	DATE	RELATIONSHIP IF OTHER THAN PT
X <i>Heather O'Brien</i>	<i>11-16-07</i>	<i>Unable to obtain Sign</i>
WITNESS	DATE	REASON PT UNABLE TO SIGN

WAIVER OF LIABILITY

MEDICARE PATIENTS:

Medicare will only pay for services that it determines to be "reasonable and necessary" under section 1862(A)(1) of the Medicare law. If Medicare determines a particular service is "not reasonable and necessary" under Medicare program standards, Medicare will deny payment for that service. In your case, Medicare may deny payment for the ambulance services about to be rendered because it may not be medically necessary for you to be transported by ambulance. I have been notified by AMR that, in my case, Medicare may deny payment for the ambulance service referenced below. If Medicare denies payment, I agree to be personally and financially responsible for full payment of my ambulance service.

MEDI-CAL PATIENTS:

Medi-Cal may determine that this ambulance transport is not a benefit of the Medi-Cal program. I have been notified by AMR that, in my case, Medi-Cal may deny payment for the ambulance service referenced below. If Medi-Cal denies payment, I agree to be personally and financially responsible for full payment of my ambulance service.

X BENEFICIARY SIGNATURE	DATE	RELATIONSHIP IF OTHER THAN PT
X		
WITNESS	DATE	REASON PT UNABLE TO SIGN



MAIL WITH CHECK OR MONEY ORDER MADE PAYABLE TO:

Ventura County Fire Protection District
165 Durley Ave., Camarillo, CA 93010
(805) 389-9710; FAX: (805) 388-4364

REQUEST FOR FIRE RECORDS

The public has a right to obtain information per the California Public Records Act. Ventura County Fire Protection District (VCFPD) makes every effort to comply with requests for public records while ensuring compliance with federal, state, and local laws (HIPAA and California Privacy).

MEDICAL RECORDS will not be released without a properly completed VCFPD "Authorization for Use & Disclosure of Protected Health Information and Records" form (VCFPD Medical Release), or by court order. Otherwise, all medical assessments will be removed (blacked out/redacted or withheld).

Please Read and Make a Selection from the Record Types Listed Below

INCIDENT REPORT (IR)

An IR is produced for each event to which VCFPD equipment and staff respond. The IR is constructed under the rules of the National Fire Incident Reporting System (NFIRS). All medical assessments will be removed without a properly completed VCFPD Medical Release.

- Incident Report - \$3.00** Does not include any medical assessments.
- Incident Report with VCFPD Medical Release - \$3.00** A properly completed VCFPD "Authorization for Use & Disclosure of Protected Health Information and Records" form must accompany this request. Any medical assessment record(s) completed by VCFPD personnel will be included with the IR. In some cases, private ambulance company personnel will make the medical assessment, in which case VCFPD may have only some or none of the medical records.

FIRE INVESTIGATION REPORT (FIR)

A FIR may be generated when members of the Investigation Unit are called to investigate the cause of a fire. Not all fires are investigated. To determine the availability of a report before submitting the request below, call the Fire Investigation Office at (805) 383-4790.

- Fire Investigation Report - \$33.00** The FIR includes the written document (hard copy of the report) with the associated pictures in a CD-ROM format. All medical assessments in written and picture form will be removed unless a completed VCFPD Medical Release form is included.
- Fire Investigation Report with VCFPD Medical Release - \$33.00** Same as the FIR above but also includes any medical assessments. A properly completed VCFPD "Authorization for Use & Disclosure of Protected Health Information and Records" form must accompany this request.

Incident Information - Please Print Legibly

Incident Number (if known, assigned by VCFPD, not by law enforcement): _____

Incident Date (required): 11/14/2006 Incident Time (approximate): 6:15 a.m. or p.m. (p.m.)

Incident Address/Location: _____

Nearest Cross Street (if known): _____ City: THOUSAND OAKS

Type of Incident (fire, traffic collision, etc.): SHOOTING VICTIM

Name of Requestor: Sgt. Bill Ayub #3318, VTA Co. Sheriff

Requestor's Mailing Address: 6401 TELEPHONE RD. STE. 200, VENTURA 93009

Requestor's Phone Number: 805-477-7019 FAX Number: 805-477-7010

requestforincidents_investigationrecords.doc

TX RESULT REPORT

NAME :SPEC VCSD MAJOR CRIMES
TEL :8054777010
DATE :JAN.04.2007 10:54

SESSION	FUNCTION	NO.	DESTINATION STATION	DATE	TIME	PAGE	DURATION	MODE	RESULT
3186	TX	001	93884364	JAN.04	10:53	001	00h00min40s	ECM	OK



Custodian of Records
Ventura County Fire Department
165 Durley Avenue, Camarillo, CA 93010
(805) 383-4790
Fax: (805) 388-4315

FAX TRANSMITTAL

DATE: 1-4-07
TO: Bill Ayub
FAX # 477-7010
FROM: Doni

TOTAL # OF PAGES (including cover): 8

COMMENTS:



Entries in this report are intended for the sole use of the Ventura County Fire Protection District. Estimations and evaluations made hereon represent "most likely" and "most probable" cause and effect. Any representation as to the validity or accuracy of reported conditions outside the Ventura County Fire Protection District is neither intended nor implied. Due to the variability in estimating property and content value and loss, the Ventura County Fire Protection District takes no position and as a consequence may reflect a \$0 estimate in the database.

The Custodian of Records for Ventura County Fire Protection District has generated the enclosed incident information from its computer database. This is a certified copy of the information contained in District records.

Incident No. 6101562 Date Issued: 1-3-06
 VCFPD Custodian of Records [REDACTED] No. of Pages: 4



VENTURA COUNTY FIRE PROTECTION DISTRICT INCIDENT REPORT

1. BASIC

Incident Date	Incident Number	Exposure	Station	Location Type
11/14/2006	6101562	000	31 - Westlake	1 Street address
[REDACTED]			Apt/Suite/Rm	City, State & Zip
[REDACTED]			[REDACTED]	Thousand Oaks, CA 91380
Cross Street			Incident Type	
[None selected]			321 EMS call, excluding vehicle accident with inju	
Aid Type	Mutual Aid Department	Their Incident Number		
N None	[None selected]	0		
Alarm Time	Arrival Time	Control Date/Time	Last Unit Cleared Time	
18:23:23	18:28:41		11/15/2006 01:49:51	
Action Taken				
33 Provide advanced life support (ALS)				
Detector (confined fires)		Property Use		
Unknown		965 Vehicle parking area		
Fire Related Casualties				
Fire Service Deaths	<u>0</u>	Fire Service Injuries	<u>0</u>	
Civilian Deaths	<u>0</u>	Civilian Injuries	<u>0</u>	
Remarks				

2. APPARATUS/PERSONNEL

Apparatus ID	Apparatus Type	Use	Number of People
E30	11 Engine	EMS	3
E31	11 Engine	EMS	3
ME34	11 Engine	EMS	3
B3	92 Chief officer car	EMS	1
LA37	62 Light and air unit	Other	3
SQ31	76 ALS unit	EMS	2



VENTURA COUNTY FIRE PROTECTION DISTRICT INCIDENT REPORT

Employee Number

- 1592
- 1621
- A702
- 1097
- 2893
- 1100
- A559
- A698
- A665
- 2436
- 3516
- A697
- 1579
- 2898
- A834

3 FIRE

Residential Units 0	On-Site Materials	Material Storage Use
Fire Origin	<input type="checkbox"/> Confined to Origin	
Heat Source	Material Type First Ignited	
Item First Ignited	Ignition Cause	
Ignition Factor	Human Factors	
Acres Burned 0	<input type="checkbox"/> Less than 1 Acre	<input type="checkbox"/> Possibly Mentally Disabled
	<input type="checkbox"/> None	<input type="checkbox"/> Physically Disabled
	<input type="checkbox"/> Asleep	<input type="checkbox"/> Multiple Persons Involved
	<input type="checkbox"/> Possibly Impaired (Alcohol/Drugs)	<input type="checkbox"/> Age was a Factor
	<input type="checkbox"/> Unattended Person	
Age 0	Gender Unknown	Mobile Property Involved
Mobile Property Type		Mobile Property Make



**VENTURA COUNTY
FIRE PROTECTION DISTRICT
INCIDENT REPORT**

4 STRUCTURE FIRE

Structure Type		Structure Status		
Above Grade Stories 0	Below Grade Stories 0			
Main Floor Square Feet 0	OR	Main Floor Length (ft.) 0	X	Main Floor Width (ft.) 0
Fire Origin Below Grade	Fire Spread	Detectors Present Unknown		
Detector Type	Detector Power Supply		Detector Operation	
Detector Effectiveness	Detector Failure Reason			
AES Present N None Present	AES Type	AES Operation		
AES Sprinkler Heads Work 0	AES Failure Reason			

7 EMS

Provider Impression

38 Trauma

Cardiac Arrest

PreArrival
 Post Arrival

Witnessed Bystander

Init Arrest Rhythm

VFIB/VTACH

Other Undetermined

Init Level Prov.

4 EMT-P (Paramedic)

Patient Number

1

8 HAZMAT

Chemical Name	Est. Amount	Units	
	0		
Cause	Contrib Factors	Disposition	

9 WILDLAND FIRE

Latitude	Longitude	AreaType	Wildland Fire Cause	Total Acres Burned
				0



Ventura County Fire Department

Detail Report for Incident 6101562

Date	Call Type	Location	City	Sector	Map Page
11/14/2006	GUNSHOT VICTIM	[REDACTED]	TO	31	18E1-84
911	Received	Dispatched	Enroute	Arrived	Cleared
	18:23:23	18:23:52	18:25:08	18:28:41	01:40:51
Unit ID	Date/Time	CAD Command	Remarks		
	11/14/2006 6:23:23 PM	REMARK	OFFICER INVOLVED SHOOTING / 1 SUBJ DOWN / STG FOR SCC		
	11/14/2006 6:23:23 PM	REMARK	*3283 // BCT		
	11/14/2006 6:23:23 PM	REMARK	CT 2222 LOS FELIZ DR		
E30	11/14/2006 6:23:52 PM	DISPATCHED			
MED452	11/14/2006 6:23:52 PM	DISPATCHED			
SQ31	11/14/2006 6:24:20 PM	DISPATCHED			
E31	11/14/2006 6:24:20 PM	DISPATCHED			
E30	11/14/2006 6:24:31 PM	CLOSE/CLEAR			
E31	11/14/2006 6:25:08 PM	ENROUTE			
SQ31	11/14/2006 6:25:12 PM	ENROUTE			
ME34	11/14/2006 6:25:43 PM	ASSIGN UNIT			
ME34	11/14/2006 6:25:43 PM	ENROUTE			
MED452	11/14/2006 6:26:12 PM	ENROUTE			
E31	11/14/2006 6:26:23 PM	CLOSE/CLEAR			
ME34	11/14/2006 6:26:43 PM	STAGED			
SQ31	11/14/2006 6:26:48 PM	STAGED			
	11/14/2006 6:27:20 PM	REMARK	RT CLR TO ENTER/IGM		
ME34	11/14/2006 6:28:06 PM	CLOSE/CLEAR			
E31	11/14/2006 6:28:13 PM	ENROUTE			
E31	11/14/2006 6:28:13 PM	ASSIGN UNIT			
B3	11/14/2006 6:28:37 PM	ASSIGN UNIT			
B3	11/14/2006 6:28:37 PM	ENROUTE			
B3	11/14/2006 6:28:41 PM	ARRIVED O/S			
MED452	11/14/2006 6:30:13 PM	ARRIVED O/S			
E31	11/14/2006 6:39:33 PM	RADIO TRAFFIC	B3 AVAIL O/S. E31/SQ31 ON HOSP F/U/IRN		
B3	11/14/2006 6:40:07 PM	AVAIL RADIO			
MED452	11/14/2006 6:41:43 PM	ENROUTE HOSPITAL	C3 ALS LRRMC 2 FF		
MED452	11/14/2006 6:48:58 PM	AT HOSPITAL	C3 ALS LRRMC 2 FF		
LA37	11/14/2006 7:14:10 PM	DISPATCHED			
LA37	11/14/2006 7:19:23 PM	ENROUTE			
LA37	11/14/2006 7:30:49 PM	STAGED			
MED452	11/14/2006 8:34:16 PM	CLOSE/CLEAR	C3 ALS LRRMC 2 FF		
B3	11/14/2006 8:34:48 PM	CLOSE/CLEAR			
SQ31	11/14/2006 9:35:34 PM	CLOSE/CLEAR			
E31	11/14/2006 9:45:44 PM	CLOSE/CLEAR			
LA37	11/14/2006 9:51:55 PM	FIRE ASSESSMENT	OUT ADL 21 HRS		
LA37	11/14/2006 9:52:30 PM	FIRE ASSESSMENT	OUT ADL 2 HRS (CORRECTION FROM LAST)		
LA37	11/15/2006 1:43:35 AM	RS			
LA37	11/15/2006 1:49:51 AM	CLOSE/CLEAR			

Report Date: Wednesday, January 03, 2007 16:50:48

STA. 31

Journal

(Pg 1)

TUESDAY

NOV 14th 2006

'B'



[Redacted]
[Redacted] information.
[Redacted]

237
[Redacted]
[Redacted]
[Redacted]
[Redacted]

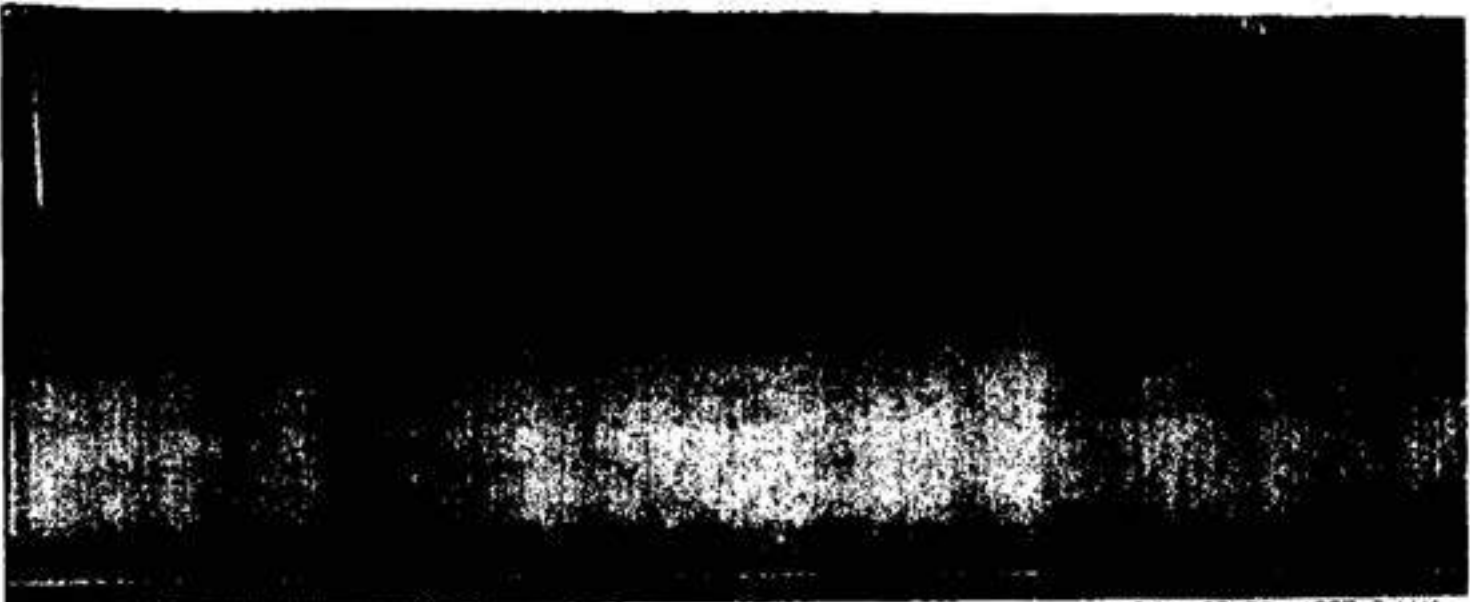

col

1.5

[REDACTED]

NARRATIVE:

FCW -

[REDACTED]

col

NARRATIVE:

CE

(150)

1.5

[REDACTED]

[REDACTED]

33
110

[REDACTED]

NARRATIVE REPORT VENTURA COUNTY SHERIFF'S DEPARTMENT

Page 1 of 9 Continuation

AGENCY IDENTIFIER CA0560000

1 RD 9072	2 BEAT 9G	3 RB NUMBER 06-30492
--------------	--------------	-------------------------

4 CODE	5 ITEM	6 QTY	7 ITEM NAME	8 BRAND / MAKE MANUFACTURER	9 MODEL NAME OR NUMBER	10 MISC. DESCRIPTION	11 IDENTIFICATION / SERIAL NUMBER	12 VALUE
--------	--------	-------	-------------	-----------------------------	------------------------	----------------------	-----------------------------------	----------

Supplemental Case Cleared

Gang Domestic Hate Child Abuse Elderly Abuse

Connecting Report Numbers:

Code Section / Description: Code Section / Description (Reclassify To:)

Officer Involved Shooting

Code: P Name: VCSD Detective Matthews, Shane

On Nov. 14, 2006, I responded to an officer involved shooting at [REDACTED]. When I arrived, I saw Ventura County Fire personnel on scene and attending to a gunshot victim, who was lying on the pavement next to a full-size white Ford pickup.

I had been informed that the shooting involved Detective Shane Matthews, who is one of my partners in the Investigations Bureau. Several deputies had arrived on scene, and were closing off the area to preserve evidence at the scene.

I saw Detective Matthews, who appeared calm and composed. I asked him if he was injured or if he was okay. Detective Matthews told me that he was okay. He was wearing the same professional clothing, which I had seen him wearing earlier that day (blue dress shirt, tie, dress slacks and black shoes). His badge was clearly displayed on his trouser belt next to his sidearm. He also wore his department identification card on a lanyard hanging around his neck.

As I walked under the yellow crime scene tape, one of the deputies pointed to a man wearing a red shirt. The deputy told me that the man in the red shirt had been present and witnessed the shooting.



13 DATE / TIME OF REPORT 11/27/06 / 11:20	14 REPORTING OFFICER / ID NO / DIV / UNIT E. Buschow #2552 / ECPS / DETS	15 APPROVED BY / ID NO <i>[Signature]</i> / 2486
--	---	---

NARRATIVE REPORT VENTURA COUNTY SHERIFF'S DEPARTMENT

Page 2 of 9 *Continuation*

AGENCY IDENTIFIER CA0560000

1 RD
9072

2 BEAT
9G

3 RB NUMBER
06-30492

4 CODE	5 ITEM	6 QTY	7 ITEM NAME	8 BRAND / MAKE MANUFACTURER	9 MODEL NAME OR NUMBER	10 MISC. DESCRIPTION	11 IDENTIFICATION / SERIAL NUMBER	12 VALUE
--------	--------	-------	-------------	-----------------------------	------------------------	----------------------	-----------------------------------	----------

I approached [REDACTED] [REDACTED], who was visibly shaking at the time. [REDACTED] gestured toward the man who had been shot and asked, "Is he gonna be okay?"

I told him that I didn't know. I asked [REDACTED] to tell me what had happened at the scene. He told me that Detective Matthews had been interviewing him about an incident involving his previous employer, General Nutrition Center.

While Matthews interviewed [REDACTED], an unidentified man approached them from the parking area of the apartment complex. As the man neared Matthews and [REDACTED], he shouted at Matthews, "Are you a cop? Are you a cop? You're not gonna get me cop! You're not gonna get me cop!"

[REDACTED] said that Matthews looked at [REDACTED] and asked if he knew the man. [REDACTED] said he told Matthews he had never seen the man before. The subject was later identified as Adran Canley (DOB 4-1-81).

Matthews called for Canley to stop, but the man walked away toward the parking lot. [REDACTED] said Matthews told Canley to stop several times. [REDACTED] told me, "Matthews kept saying 15 million times, 'Stop! Stop!'"

At first Canley walked, but then began running down the concrete walkway along the west side of the parking area. Detective Matthews ran after Canley.

Canley entered a white Ford pickup, which was parked facing west on the west side of the parking lot. Canley began to back out of the parking space. Detective Matthews was still shouting at the man to stop.

The pickup backed out of the parking space with the rear of the truck turning south. The pickup then accelerated forward (northbound) toward Detective Matthews and toward the only exit of the parking lot, which goes toward Los Feliz Drive. By that point, [REDACTED] said that Detective Matthews was in a position where he was in front of the pickup directly in its path. Matthews had drawn his sidearm, and continued shouting at the man to stop. The pickup accelerated forward, at which time Detective Matthews fired a single shot in the left front tire of the pickup.

The pickup continued to advance, and Detective Matthews continued shouting at Canley to stop. When the pickup did not stop, Matthews fired additional shots into the pickup as he jumped away from the path of the oncoming pickup. The truck came to rest against the curb at the north end of the parking lot facing the clubhouse. [REDACTED] said he thought he heard three gunshots being fired by Matthews, including the first one into the left front tire.

While we stood there discussing the incident, I noticed a notebook in the grass adjacent to the walkway that extends from the apartments to the parking lot. I asked [REDACTED] if the notebook was

13 DATE / TIME OF REPORT 11/27/06 / 11:20	14 REPORTING OFFICER / ID NO / DIV / UNIT E. Buschow #2552 / ECPS / DETS	15 APPROVED BY / ID NO <i>[Signature]</i> / 2785
--	---	---

NARRATIVE REPORT VENTURA COUNTY SHERIFF'S DEPARTMENT

Page 3 of 9 Continuation

AGENCY IDENTIFIER CA0560000

1 RD
9072

2 BEAT
9G

3 RB NUMBER
06-30492

4 CODE	5 ITEM	6 QTY	7 ITEM NAME	8 BRAND / MAKE MANUFACTURER	9 MODEL NAME OR NUMBER	10 MISC DESCRIPTION	11 IDENTIFICATION / SERIAL NUMBER	12 VALUE
--------	--------	-------	-------------	-----------------------------	------------------------	---------------------	-----------------------------------	----------

Matthews'. ██████ told me that it belonged to Matthews, and that the detective threw the notebook on the grass as he ran after Canley.

██████ told me several times that he couldn't understand why Canley acted the way he did, and why he didn't stop for Detective Matthews. ██████ told me that Detective Matthews helped Canley out of the pickup and rendered first aid to the man. ██████ said he heard Matthews say to Canley that he was going to be okay.

Matthews instructed ██████ to call 9-1-1, which he said he did from his cellular telephone. I asked ██████ if anyone else was present during the shooting. He said he was not aware of any other witnesses in the area at the time. I had a brief discussion with Deputy Axelrod, who said he thought there was another witness in the parking lot at the time. When Axelrod described the person to ██████, ██████ said that the man in question did not show up at the scene until after the shooting occurred.

I asked ██████ if he was afraid during the incident. At first he told me that he wasn't. Then he told me that he was afraid when he heard the first shot being fired.

██████ told me, "If somebody fires a gun at you, especially a police officer pulls out a gun...and if you're gonna push him that far to fire, then I was kind of afraid he would have done something to Matthews or me. If someone pulls a gun, you don't try to get away or anything like that. Do you know what I mean? That's why I thought maybe...I'm not saying Matthews is a bad shooter, but if...I was afraid if he fired, the guy was going to turn around and fire or something like that. For a person to resist an officer who is holding a gun and shoots the tire. One shot...that shouldn't even be that... taking it that far. If he goes to that extent, who knows how far it's going to go? You know what I mean? After the shots, I was worried the guy was going to do something to Matthews."

After the shots, Detective Matthews ordered Canley out of the pickup. Canley said, "I'm hit! I'm hit!"

Matthews then told Canley that he was going to be okay. ██████ said that as Matthews helped Canley out of the pickup, Matthews told Canley, "Just hang on with me buddy! After that they were like friends, you know?"

"He [Matthews] was trying to calm him down," ██████ said. "He was trying to help him. That's all he wanted to do."

██████ told me, "I feel really bad for Matthews. I really do. He did not want to fire."

██████ said he didn't understand why Canley confronted Detective Matthews. He said, "I'm thinking to myself...Buddy, whatever you did...you see him talking to me. I'm not saying to get away with it. You see the cop there, not bothering you. What are you trying to do? Why are you standing there? He totally instigated it. You see a cop talking to me...leave us alone. If you're a criminal, then get the hell

13 DATE / TIME OF REPORT 11/27/06 / 11:20	14 REPORTING OFFICER / ID NO / DIV / UNIT E. Buschow #2552 / ECPS / DETS	15 APPROVED BY / ID NO <i>[Signature]</i> / 2785
--	---	---

NARRATIVE REPORT VENTURA COUNTY SHERIFF'S DEPARTMENT

Page 4 of 9 *K* Continuation

AGENCY IDENTIFIER CA0560000

1 RD 9072	2 BEAT 9G	3 RB NUMBER 06-30492
--------------	--------------	-------------------------

4 CODE	5 ITEM	6 QTY	7 ITEM NAME	8 BRAND / MAKE MANUFACTURER	9 MODEL NAME OR NUMBER	10 MISC. DESCRIPTION	11 IDENTIFICATION / SERIAL NUMBER	12 VALUE
--------	--------	-------	-------------	-----------------------------	------------------------	----------------------	-----------------------------------	----------

out. That was pure stupidity. You don't push it to that level. He [Matthews] wouldn't have even seen the guy if the guy didn't open his mouth. What does that tell you?"

██████ was cooperative and remained at the scene at my request. A short while later, Detective Sgt. Rhods interviewed ██████ a second time. Refer to Rhods' report for further details.

13 DATE / TIME OF REPORT 11/27/06 / 11:20	14 REPORTING OFFICER / ID NO / DIV / UNIT E. Buschow #2552 / ECPS / DETS	15 APPROVED BY / ID NO <i>[Signature]</i> / 2486
--	---	---

NARRATIVE REPORT VENTURA COUNTY SHERIFF'S DEPARTMENT

Page 5 of 9 Continuation

AGENCY IDENTIFIER CA0560000

1 RD
9072

2 BEAT
9G

3 RB NUMBER
06-30492

4 CODE	5 ITEM	6 QTY	7 ITEM NAME	8 BRAND / MAKE MANUFACTURER	9 MODEL NAME OR NUMBER	10 MISC. DESCRIPTION	11 IDENTIFICATION / SERIAL NUMBER	12 VALUE
--------	--------	-------	-------------	-----------------------------	------------------------	----------------------	-----------------------------------	----------

During a neighborhood canvass, I contacted, or attempted to make contact with residents at the following locations:



When I entered apartment [REDACTED] I noticed that the rear sliding door was open, and afforded the occupants a partial elevated view of the police activity at the crime scene. However, the actual shooting scene and location of the pickup were obscured by the clubhouse, which is located between apartment [REDACTED] and the crime scene.

[REDACTED] said he and his family were watching television in the front room of their apartment, which is next to the open sliding door that leads to the balcony facing to the south toward the crime scene.

[REDACTED] said he heard three gunshots and then two additional gunshots approximately three or four seconds later. He said he and his family heard screaming after the gunshots, but couldn't make out any words. He said that he and his family heard nothing before the incident.

[REDACTED] said he looked outside and saw a man in a red t-shirt holding what appeared to be a phone to his ear. [REDACTED] said he saw no other activity until emergency personnel arrived on scene.

At home with [REDACTED] at the time were the following family members:



All of the occupants of apartment [REDACTED] gave consistent statements. I asked [REDACTED] if he or any family members looked outside after hearing the shots. He said he did not look outside, nor did he let his family look or go outside. He said he told everybody present that they couldn't go outside until after the police were there.

13 DATE / TIME OF REPORT
11/27/06 / 11:20

14 REPORTING OFFICER / ID NO / DIV / UNIT
E. Buschow #2552 / ECPS / DETS

15 APPROVED BY / ID NO
[Signature] / 2485

NARRATIVE REPORT VENTURA COUNTY SHERIFF'S DEPARTMENT

Page 6 of 7 Continuation

AGENCY IDENTIFIER CA0560000

1 RD
9072

2 BEAT
9G

3 RB NUMBER
06-30492

4 CODE	5 ITEM	6 QTY	7 ITEM NAME	8 BRAND / MAKE MANUFACTURER	9 MODEL NAME OR NUMBER	10 MISC DESCRIPTION	11 IDENTIFICATION / SERIAL NUMBER	12 VALUE
--------	--------	-------	-------------	-----------------------------	------------------------	---------------------	-----------------------------------	----------

After a few minutes, I asked again if they saw or heard anything after the gunshots. [REDACTED] said he was going to call 9-1-1. He looked out the sliding door and saw a man wearing a red shirt and brown shorts making a phone call. [REDACTED] said he thought the man was calling 9-1-1.

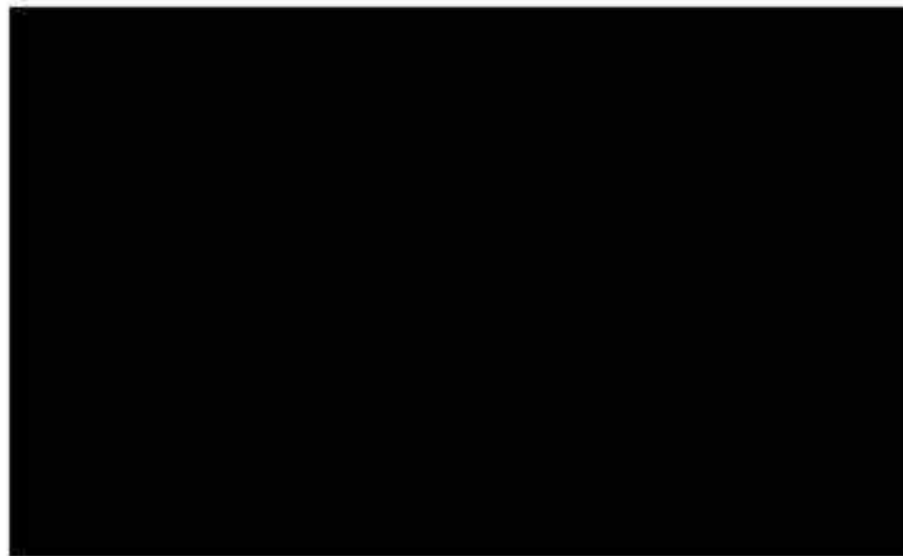

Both [REDACTED] and [REDACTED] live in apartment [REDACTED]. They were home when the shooting occurred, and the rear sliding door of the apartment was open. The small balcony has a view directly across to the clubhouse to the south. The shooting took place on the opposite side of the clubhouse from their apartment. The residents of apartment [REDACTED] did not have a view of the crime scene at all. The television was on at the time of the incident.

[REDACTED] told me that he heard nothing prior to hearing what he thought were six gunshots. He described the sounds as two in close sequence, a brief pause, and then four shots in close sequence.

[REDACTED] said she heard two shots, then heard someone yelling "Stop, Stop!" She then heard the additional shots. [REDACTED] concurred with what [REDACTED] said she heard.



I encountered [REDACTED] [REDACTED] in the parking lot in front of the apartments near #107. He was walking toward his apartment, where there had been no answer earlier. I began to question him about what he had seen or heard that evening. He was extremely uncooperative, but said spontaneously about the shooting, "I wonder if it was that guy that just got out of CYA."

13 DATE / TIME OF REPORT
11/27/06 / 11:20

14 REPORTING OFFICER / ID NO / DIV / UNIT
E. Buschow #2552 / ECPS / DETS

15 APPROVED BY / ID NO
[Signature] / 2486

NARRATIVE REPORT VENTURA COUNTY SHERIFF'S DEPARTMENT

Page 7 of 9 Continuation

AGENCY IDENTIFIER CA0560000

1 RD
9072

2 BEAT
9G

3 RB NUMBER
06-30492

4 CODE	5 ITEM	6 QTY	7 ITEM NAME	8 BRAND / MAKE MANUFACTURER	9 MODEL NAME OR NUMBER	10 MISC. DESCRIPTION	11 IDENTIFICATION / SERIAL NUMBER	12 VALUE
--------	--------	-------	-------------	-----------------------------	------------------------	----------------------	-----------------------------------	----------

I asked him whom he was talking about. He said he did not want to get involved or give any information. [REDACTED] seemed nervous, and appeared to be under the influence of a controlled substance. His pupils were approximately 8.5 mm in the well-illuminated area where we were standing. I asked [REDACTED] if he was on probation or parole. He told me that he is on probation for drugs. I told him that he appeared to be "high." He said, "Well, I have a letter for medical marijuana."

I asked him why he would be allowed to use illegal drugs if he is on probation for drugs. He said he uses marijuana to treat his sleep apnea.

[REDACTED] claimed he had no additional information and continued to be uncooperative. I asked [REDACTED] when he got home. He said he had just walked up toward his apartment when I began to question him. He said he works at Ben & Jerry's ice cream shop on Thousand Oaks Boulevard and Conejo School Road, and had just come home from work. Since [REDACTED] was not present when the shooting occurred, I ended the interview.



I went to apartment 105 at approximately 2008 hours. [REDACTED] [REDACTED] told me that he had heard three or four shots approximately one hour earlier. He said that he and his family had been home for approximately ten minutes prior to hearing the shots. The rear sliding door was closed, and they did not see anything related to the incident.

[REDACTED] said he heard the sirens a short time later. He said he didn't want to go outside to see what was going on, because of the gunshots.

Neither [REDACTED], his wife, nor his daughter had any additional information about the incident.

13 DATE / TIME OF REPORT
11/27/06 / 11:20

14 REPORTING OFFICER / ID NO / DIV / UNIT
E. Buschow #2552 / ECPS / DETS

15 APPROVED BY / ID NO
[Signature] / 12486

NARRATIVE REPORT VENTURA COUNTY SHERIFF'S DEPARTMENT

Page 8 of 9 Continuation

AGENCY IDENTIFIER CA0560000

1 RD
9072

2 BEAT
9G

3 RB NUMBER
06-30492

4 CODE	5 ITEM	6 QTY	7 ITEM NAME	8 BRAND / MAKE MANUFACTURER	9 MODEL NAME OR NUMBER	10 MISC. DESCRIPTION	11 IDENTIFICATION / SERIAL NUMBER	12 VALUE
--------	--------	-------	-------------	-----------------------------	------------------------	----------------------	-----------------------------------	----------



I contacted [REDACTED] in her apartment. She told me that she was home at the time of the incident, but didn't hear anything until she heard the sirens of emergency vehicles responding after the shooting had taken place.

[REDACTED] had a guest at her apartment on the evening of Nov. 14, 2006. [REDACTED] was in the apartment when she heard three gunshots. She said she knew they were gunshots, because she lives in Los Angeles and has heard shots many times before.

[REDACTED] said she was working on the computer between 1800 and 1900 hours when the shooting occurred. Neither she nor [REDACTED] saw nor heard anything else until emergency equipment began arriving at the apartment complex.

[REDACTED]'s apartment has a view to the east out the back, and the front door faces west. There is no view of the area where the shooting took place from inside the apartment.



There is a retirement home just west of the scene where the shooting took place. It is a three-story structure with apartments that face east toward the area of the shooting. I went with a team of detectives to contact all of the residents whose apartments faced the crime scene.



13 DATE / TIME OF REPORT 11/27/06 / 11:20	14 REPORTING OFFICER / ID NO / DIV / UNIT E. Buschow #2552 / ECPS / DETS	15 APPROVED BY / ID NO <i>[Signature]</i> / 2486
--	---	---

NARRATIVE REPORT VENTURA COUNTY SHERIFF'S DEPARTMENT

Page 9 of 9 *K* Continuation

AGENCY IDENTIFIER CA0560000

1 RD
9072

2 BEAT
9G

3 RB NUMBER
06-30492

4 CODE	5 ITEM	6 QTY	7 ITEM NAME	8 BRAND / MAKE MANUFACTURER	9 MODEL NAME OR NUMBER	10 MISC. DESCRIPTION	11 IDENTIFICATION / SERIAL NUMBER	12 VALUE
--------	--------	-------	-------------	-----------------------------	------------------------	----------------------	-----------------------------------	----------

I spoke to the [REDACTED] at 2050 hours. The [REDACTED] told me they were home at the time of the incident, but neither of them saw or heard anything related to the shooting. Their balcony actually faces south toward the Civic Arts Plaza, and they have no view of the area where the shooting occurred.

[REDACTED]

I spoke with [REDACTED], who told me that she was downstairs having dinner in the dining room earlier in the evening until approximately 1800 hours. Immediately after dinner, she remained downstairs and used one of the computers in the computer room. She said she didn't see or hear anything related to the shooting.

[REDACTED]

[REDACTED] said she ate dinner downstairs between 1700 and 1800 hours. She said she returned to her apartment at approximately 1815 hours. She said she didn't know there was another apartment complex behind the retirement home. She said she didn't see or hear anything related to the shooting.

[REDACTED]

[REDACTED] suffers dementia, and had me confused with the UPS delivery man. She had no information related to the shooting.

[REDACTED]

13 DATE / TIME OF REPORT
11/27/06 / 11:20

14 REPORTING OFFICER / ID NO / DIV / UNIT
E. Buschow #2552 / ECPS / DETS

15 APPROVED BY / ID NO
[Signature] / 2986

NARRATIVE REPORT VENTURA COUNTY SHERIFF'S DEPARTMENT

Page 1 of 8

Continuation

AGENCY IDENTIFIER CA0560000

1 RD	2 BEAT	3 RB NUMBER
9072	9G01	06-30492

4 CODE	5 ITEM	6 QTY	7 ITEM NAME	8 BRAND / MAKE MANUFACTURER	9 MODEL NAME OR NUMBER	10 MISC. DESCRIPTION	11 IDENTIFICATION / SERIAL NUMBER	12 VALUE
--------	--------	-------	-------------	-----------------------------	------------------------	----------------------	-----------------------------------	----------

- Supplemental Case Cleared
 Gang Domestic Hate Child Abuse Elderly Abuse

Connecting Report Numbers:

Code Section / Description: Officer Involved Shooting

Reclassify to:

Code: P-1 **Name:** Canley, Adrian

On November 14, 2006, at approximately 1845 hrs. I received a telephone call at my home from Captain Kelley. He informed me that there had been an officer involved shooting and asked me to respond and assist with the investigation. Captain Kelley further instructed me to respond to [REDACTED] Dr. in the City of Thousand Oaks.

I arrived at the scene at approximately 1905 hrs, where I met with Sergeant Powers. Sergeant Powers briefed me on the circumstances surrounding the shooting. Sergeant Powers told me that Detective Shane Matthews was at the location conducting an investigation when he was forced to shoot a subject in a white pickup truck that was now parked nearby. Sergeant Powers then asked me to contact and interview the subject Detective Matthews was meeting with. I was directed to a subject who was standing nearby. At 1915 Hrs, I introduced myself and he identified himself as [REDACTED]. I confirmed with Mr. [REDACTED] that he was talking to Detective Matthews before the shooting. [REDACTED] told me he was and that he saw the whole thing. The following is a synopsis of my interview with Mr. [REDACTED], which was digitally recorded.

13 DATE / TIME OF REPORT	14 REPORTING OFFICER / ID NO. / DIV / UNIT	15 APPROVED BY / ID NO.
11-21-06 / 1459	Sgt. S. Rhods/#1438/Special Services	

NARRATIVE REPORT VENTURA COUNTY SHERIFF'S DEPARTMENT

Page 2 of 8

Continuation

AGENCY IDENTIFIER CA0560000

1. RD 9072	2. BEAT 9G01	3. RB NUMBER 06-30492
---------------	-----------------	--------------------------

4. CODE	5. ITEM	6. QTY	7. ITEM NAME	8. BRAND / MAKE MANUFACTURER	9. MODEL NAME OR NUMBER	10. MISC. DESCRIPTION	11. IDENTIFICATION / SERIAL NUMBER	12. VALUE
---------	---------	--------	--------------	------------------------------	-------------------------	-----------------------	------------------------------------	-----------

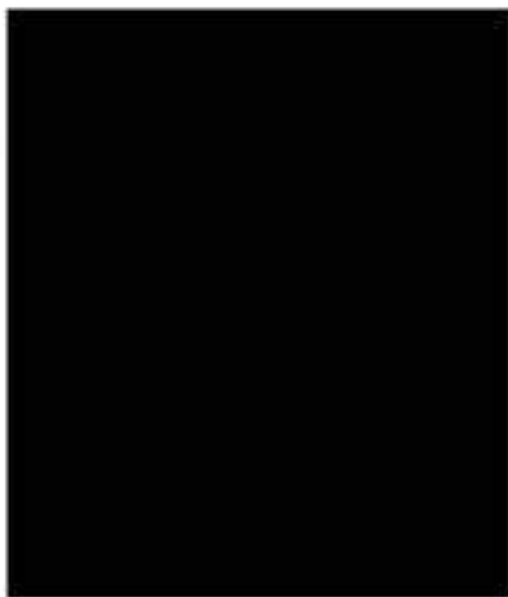

██████████ and I started our conversation in the front seat of my car. As we were walking to my car, I confirmed with him that he was not hurt. After obtaining ██████████'s personal information, I asked him to tell me what had happened.

██████████ told me that Detective Matthews came to his apartment to speak to him about a place he once worked at called GNC. ██████████ said he and Matthew's talked about a theft at work and if he (██████████) had ever seen another employee take anything. I confirmed Detective Matthews was there to talk to ██████████ about some employee thefts. I confirmed with ██████████ that Detective Matthews was speaking to him as a witness to this employee theft. ██████████ said, "Right."

██████████ told me that as they are talking the suspect approached them and demanded to know, "Are you Sheriff?" ██████████ said he and Matthews looked at each other. ██████████ said neither of them responded to the suspect and the suspect continues to say, "You'll never catch me." ██████████ said he was trying to ignore the suspect and it seemed to him like Matthews was trying to ignore him.

██████████ said he and Matthews continued to talk a little longer. ██████████ said it appeared to him that Matthews was ignoring the subject. ██████████ said he watched the suspect as he started

13. DATE / TIME OF REPORT 11-21-06 / 1459	14. REPORTING OFFICER / ID NO / DIV / UNIT Sgt. S. Rhods/#1438/Special Services	15. APPROVED BY / ID NO <i>[Signature]</i>
--	--	---

NARRATIVE REPORT VENTURA COUNTY SHERIFF'S DEPARTMENT

Page 3 of 8 Continuation

AGENCY IDENTIFIER CA0560000

1. RD 9072	2. BEAT 9G01	3. RB NUMBER 06-30492
---------------	-----------------	--------------------------

4. CODE	5. ITEM	6. QTY	7. ITEM NAME	8. BRAND / MAKE MANUFACTURER	9. MODEL NAME OR NUMBER	10. MISC. DESCRIPTION	11. IDENTIFICATION / SERIAL NUMBER	12. VALUE
---------	---------	--------	--------------	------------------------------	-------------------------	-----------------------	------------------------------------	-----------

walking back to his truck. [REDACTED] said as the suspect walked back to his truck he stopped and just stood on the sidewalk. [REDACTED] said he and Matthews continued to talk and as they concluded their conversation, they started walking together along the west sidewalk towards the parking lot. [REDACTED] said the suspect was still standing on the sidewalk as they walked towards him.

[REDACTED] said as they approached the suspect he started running towards his truck. [REDACTED] told me that at the same time Matthews was yelling, "Stop, stop, stop." [REDACTED] said Matthews was pounding on the window of the truck with his fist. [REDACTED] said the suspect was inside his truck and suddenly started up the truck and started backing out. [REDACTED] said as the suspect was backing the truck up, Matthews pulled out his gun, and at the same time is yelling, "Stop, stop, stop." [REDACTED] told me the suspect backed out and then a started pulling forward and that is when Matthews shoots the tire. [REDACTED] said after shooting the tire, Matthews yelled, "Stop." [REDACTED] stated that after he shot the tire, Matthews moved to the side and fired twice more at the driver's side of the truck. [REDACTED] said after that the truck slowed and drifted to the right where it rolled to a stop against a curb.

[REDACTED] told me after the truck came to a stop he heard Matthews yell at the suspect, "Get out of the car." [REDACTED] told me that he heard the subject say something like, "I'm hit." [REDACTED] stated that the suspect opened the door and then he heard Matthews say, "Call 911." [REDACTED] said he called 911 and told dispatch that Detective Matthews had been involved in a shooting. [REDACTED] told me Matthews was telling the suspect, "Hold on buddy I'm going to get you some help." [REDACTED] said Matthews was "Kind of appeasing the guy." [REDACTED] told me that soon after police and fire arrived on the scene.

I asked [REDACTED] where he and Detective Matthews were standing when they were talking. [REDACTED] told me they were in front of the stairs. I asked [REDACTED] where the stairs were in relation to where I met him in the parking lot near the crime scene. [REDACTED] suggested he be allowed to walk through the sequence of events. I told him I thought that would be a good idea.

13. DATE / TIME OF REPORT 11-21-06 / 1459	14. REPORTING OFFICER / ID NO / DIV / UNIT Sgt. S. Rhods/#1438/Special Services	15. APPROVED BY / ID NO 
--	--	--

NARRATIVE REPORT VENTURA COUNTY SHERIFF'S DEPARTMENT

Page 4 of 8

Continuation

AGENCY IDENTIFIER CA0560000

1 RD 9072	2 BEAT 9G01	3 RB NUMBER 06-30492
---------------------	-----------------------	--------------------------------

4 CODE	5 ITEM	6 QTY	7 ITEM NAME	8 BRAND / MAKE MANUFACTURER	9 MODEL NAME OR NUMBER	10 MISC DESCRIPTION	11 IDENTIFICATION / SERIAL NUMBER	12 VALUE
--------	--------	-------	-------------	-----------------------------	------------------------	---------------------	-----------------------------------	----------

█████ escorted me to the Southeast corner of the complex and a set of stairs to a two-story building directly south of the parking lot where the shooting occurred. There was also a sidewalk along the west edge of this parking lot.

█████ and I stopped on this sidewalk near the entrance of a courtyard that separates two apartment buildings. I asked █████ where he and Matthews were talking. █████ pointed to a set of stairs off to our left that were about thirty yards away. █████ told me this was where he and Matthews were talking. █████ explained he was sitting on the second or third step facing the parking lot. █████ said Matthews was facing him and had his back to the parking lot.

█████ then indicated that the suspect was walking south on the sidewalk from the parking lot towards the apartment buildings and was headed towards the building on the right side of the courtyard. █████ said he thought the suspect saw a badge or something and said to Matthews, "you a cop, you'll never catch me, or I won't go that easy or something like that." █████ said Matthews did not say anything to the suspect.

█████ said he and Matthews continued to talk. Matthews said he had to go and they started walking North on the sidewalk towards the parking lot. █████ said the suspect had remained on the sidewalk about thirty yards from where they were standing. █████ said as he and Matthews were walking back to their cars when all of a sudden, the suspect started running and Matthews started running after him and was yelling over and over, "Stop."

█████ said the suspect got into his car which was parked in the third parking stall from the entrance of the parking lot and on the west side of the parking lot. █████ also stated the suspects car was parked nose in.

█████ said after the suspect got into his truck and Matthews ran up to the driver's door he began beating on the door with his fist. █████ said the suspect ignored Matthews and started backing his truck out of the parking spot. █████ said Matthews was now standing in front of the suspect's truck near the left front corner. █████ said Matthews pulled out his gun and

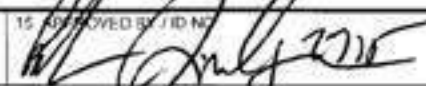
13 DATE / TIME OF REPORT 11-21-06 / 1459	14 REPORTING OFFICER / ID NO / DIV / UNIT Sgt. S. Rhods/#1438/Special Services	15 APPROVED BY / ID NO 
--	--	---

NARRATIVE REPORT VENTURA COUNTY SHERIFF'S DEPARTMENT

Page 5 of 8 Continuation

AGENCY IDENTIFIER CA0560000

1 RD	2 BEAT	3 RB NUMBER
9072	9G01	06-30492

4 CODE	5 ITEM	6 QTY	7 ITEM NAME	8 BRAND / MAKE MANUFACTURER	9 MODEL NAME OR NUMBER	10 MISC DESCRIPTION	11 IDENTIFICATION / SERIAL NUMBER	12 VALUE
--------	--------	-------	-------------	-----------------------------	------------------------	---------------------	-----------------------------------	----------

yelled at the suspect, "Stop, stop, stop" while pointing his gun at the suspect. [REDACTED] confirmed Matthews was standing at the corner of the truck not in front of it. [REDACTED] said as the truck pulled forward, Matthews fired a shot at the tire. [REDACTED] said the suspect continued to drive forward at the same time; Matthews stepped to the side and shoots two more shoots as the truck rolled past him. I asked [REDACTED] if it looked to him like the truck was driving at Matthews. [REDACTED] said, "The first time, yes and maybe even the second time." I asked [REDACTED] if Matthews had not stepped to the side after he fired that first shot, did he think the truck would have hit Matthews. [REDACTED] said, "Maybe not, because Matthews was on the corner." I asked [REDACTED] if he could estimate how fast the truck was going. [REDACTED] said, "He was trying to speed up. He was trying to get the hell out." I asked [REDACTED] if he could hear the engine revving. [REDACTED] said, "Oh yeah, yeah." I asked [REDACTED] if he heard the tires squealing. [REDACTED] said yes for a brief second.

I confirmed with [REDACTED] that the truck backed out of the parking stall. [REDACTED] said Matthew's pulled out his gun, runs and stands in front of the truck. Then yells Stop, stop. [REDACTED] said the guy put the truck in gear and started heading towards Matthews so he shoots the tires while yelling, "Stop, stop."

I asked [REDACTED] what happened next. [REDACTED] said the truck rolled across the parking lot entrance and stopped at the north curb of the parking lot. [REDACTED] said Matthews ducked down and moved up to the driver's side. I asked [REDACTED] if Matthews was yelling at the driver. [REDACTED] said Matthews was yelling at the driver, "Get out of the car. Get out of the car." [REDACTED] said he heard the suspect say, "I'm hit. I'm hit." [REDACTED] said Matthews opened the driver's door and asked the suspect where are you hit. [REDACTED] said Matthews then started talking to the suspect telling him they were getting him help and that he was going to be okay.

I asked [REDACTED] where he was while all this was happening. [REDACTED] pointed at the sidewalk on the west edge of the parking lot and said, "Right there in the middle of the street." [REDACTED] said as Matthews opened the driver's door he moved to the end of the sidewalk.

13 DATE / TIME OF REPORT	14 REPORTING OFFICER / ID NO / DIV / UNIT	15 APPROVED BY / ID NO
11-21-06 / 1459	Sgt. S. Rhods/#1438/Special Services	

NARRATIVE REPORT VENTURA COUNTY SHERIFF'S DEPARTMENT

Page 6 of 8 Continuation

AGENCY IDENTIFIER CA0560000

1 RD 9072	2 BEAT 9G01	3 RS NUMBER 06-30492
---------------------	-----------------------	--------------------------------

4 CODE	5 ITEM	6 QTY	7 ITEM NAME	8 BRAND / MAKE MANUFACTURER	9 MODEL NAME OR NUMBER	10 MISC DESCRIPTION	11 IDENTIFICATION / SERIAL NUMBER	12 VALUE
--------	--------	-------	-------------	-----------------------------	------------------------	---------------------	-----------------------------------	----------

I asked [REDACTED] if he saw anybody else outside when all this was going on. [REDACTED] said he did not see anybody else. [REDACTED] told me he called 911 from his cell phone while he was standing on the sidewalk and after Matthews opened the driver's door.

I asked [REDACTED] if he the suspect was being real aggressive or was he just acting like a knucklehead. [REDACTED] said the suspect was trying to instigate something. [REDACTED] said he and Matthews did not pay any attention to the suspect.

I asked [REDACTED] how Matthews was dressed. [REDACTED] told me he was in business attire, blue shirt and a tie. I asked [REDACTED] if he could see a gun on Matthews. [REDACTED] said he had a cell phone but he did not notice a gun. I asked if Matthews was wearing a coat. [REDACTED] said Matthews was not wearing a coat. [REDACTED] said he did see Matthews badge and a cell phone. [REDACTED] said the suspect apparently thought, "we were cops."

I asked [REDACTED] if Matthews said anything to him when he started yelling at the suspect to stop. I suggested Matthews may have said stay back or shout any warning to him. [REDACTED] said, "NO, he just ran up to the guy and the guy kept running." [REDACTED] said it was while the guy was backing his truck away from Matthews that was when he was told to call 911.

I confirmed with [REDACTED] that his opinion was that when the suspect backed the truck up and was revving the engine up he was going to burn out as quickly as he could. [REDACTED] said it looked to him like the guy had hit Matthews he would not have stopped to help him he would have kept on going. I asked [REDACTED] if he thought Matthews would have been hit. [REDACTED] said, "Yes, until he shot the tire. That is when Matthews moved to the side and fired the two shots. I asked [REDACTED] if the truck was rolling towards Matthews when he fired that first shot. [REDACTED] said, "Yes, yes because he put it in forward and started going and that's when he shot the tires."

I asked [REDACTED] about how far was Matthews was when he fired that first shot at the tires. [REDACTED] demonstrated by standing about eight to ten feet from the left front corner of a parked vehicle. I confirmed the truck was moving forward at that point. [REDACTED] then demonstrated

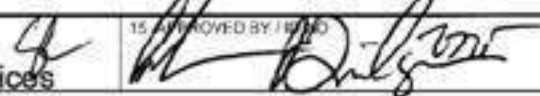
13 DATE / TIME OF REPORT 11-21-06 / 1459	14 REPORTING OFFICER / ID NO / DIV / UNIT Sgt. S. Rhods/#1438/Special Services	15 APPROVED BY / ID NO 
--	--	---

NARRATIVE REPORT VENTURA COUNTY SHERIFF'S DEPARTMENT

Page 7 of 8

Continuation

AGENCY IDENTIFIER CA0560000

1 RD	2 BEAT	3 RB NUMBER
9072	9G01	06-30492

4 CODE	5 ITEM	6 QTY	7 ITEM NAME	8 BRAND / MAKE MANUFACTURER	9 MODEL NAME OR NUMBER	10 MISC DESCRIPTION	11 IDENTIFICATION / SERIAL NUMBER	12 VALUE
--------	--------	-------	-------------	-----------------------------	------------------------	---------------------	-----------------------------------	----------

using the parked car to show that Matthews ran to the side of the truck and positioned himself about five feet from the driver's door. [REDACTED] confirmed he was about that distance when he fired the next two shots.

I asked [REDACTED] how many shots were fired in total. [REDACTED] said, "Three, and one of them into the tire. I asked [REDACTED] if he knew if Matthews hit the tire. [REDACTED] said, "Oh I know he hit the tire." [REDACTED] said he heard the explosion of the tire.

I again asked [REDACTED] where he was when this occurred. He confirmed he was on the sidewalk leading to his apartment building but he could see the whole thing. I asked [REDACTED] if when the gun came out and the shooting started did he take cover by getting down behind anything. [REDACTED] said, "No." I asked [REDACTED] if he felt threatened by the suspect in the truck or did he feel threatened for Matthews. [REDACTED] said he felt threatened for Matthews. [REDACTED] said, "Because I felt really scared for Matthews that's why I ran up a little closer. Because a guy who resists a gunshot like that I don't think has any remorse." [REDACTED] said, "If a person pushes a cop that far then ... When a cop tells you to stop and you don't want to stop... you better stop and if a cop pulls out a gun buddy stop, don't push him to fire."

I asked [REDACTED] if the suspect mentioned what he might have been wanted for. [REDACTED] said he did not say anything. [REDACTED] said Matthews asked him if he knew the suspect right after the suspect first made contact with them. [REDACTED] said he told Matthews he did not know him. [REDACTED] said he has never seen the suspect before and does not know him. I asked [REDACTED] if he had ever seen the truck before. [REDACTED] said, "No."

[REDACTED] again said, "The guy wanted to instigate something." I asked [REDACTED] how long he and Matthews talked after the suspect first approached them. [REDACTED] said it was about thirty more seconds.

I asked [REDACTED] if he saw a weapon in the suspect's hands when Matthews started chasing the suspect. [REDACTED] said no.

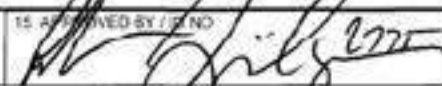
13 DATE / TIME OF REPORT	14 REPORTING OFFICER / ID NO / DIV / UNIT	15 APPROVED BY / ID NO
11-21-06 / 1459	Sgt. S. Rhods/#1438/Special Services	

NARRATIVE REPORT VENTURA COUNTY SHERIFF'S DEPARTMENT

Page 8 of 8 Continuation

AGENCY IDENTIFIER CA0560000

1 PD 9072	2 BEAT 9G01	3 RB NUMBER 06-30492
--------------	----------------	-------------------------

4 CODE	5 ITEM	6 QTY.	7 ITEM NAME	8 BRAND / MAKE MANUFACTURER	9 MODEL NAME OR NUMBER	10 MISC. DESCRIPTION	11 IDENTIFICATION / SERIAL NUMBER	12 VALUE
--------	--------	--------	-------------	-----------------------------	------------------------	----------------------	-----------------------------------	----------

I provided [REDACTED] my business card and told him that he would remember some detail and told him to call me.

This interview was concluded at 1945 Hrs. (*The incorrect time of 1745 Hrs was stated.*) For complete details of this interview, refer to the attached C.D.

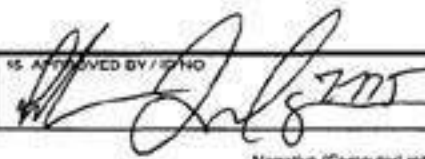
13 DATE / TIME OF REPORT 11-21-06 / 1502	14 REPORTING OFFICER / ID NO / DIV / UNIT Sgt. S. Rhods/#1438/Special Services	15 APPROVED BY / ID NO 
---	---	---

NARRATIVE REPORT VENTURA COUNTY SHERIFF'S DEPARTMENT

Page 4 of 2 Continuation

AGENCY IDENTIFIER CA0560000

1 RD 9072	2 BEAT 9G	3 RB NUMBER 06-30492
--------------	--------------	-------------------------

4 CODE	5 ITEM	6 QTY	7 ITEM NAME	8 BRAND / MAKE MANUFACTURER	9 MODEL NAME OR NUMBER	10 MISC DESCRIPTION	11 IDENTIFICATION / SERIAL NUMBER	12 VALUE
--------	--------	-------	-------------	-----------------------------	------------------------	---------------------	-----------------------------------	----------

- Supplemental Case Cleared
 Gang Domestic Hate Child Abuse Elderly Abuse

Connecting Report Numbers:

Code Section / Description: Officer Involved Shooting

Code: S-1 Name: Canley, Adrian

On 11-14-06 at about 2100 hours, I assisted several other deputies with contacting the residents of [REDACTED] is located at [REDACTED], [REDACTED] in Thousand Oaks. We were attempting to locate any witnesses to an officer involved shooting incident in which Detective Shane Matthews #3127 shot S-Adrian Canley who was attempting to drive over Detective Matthews with his (Canley's) vehicle.

At about 2100 hours, I rang the doorbell to apartment # [REDACTED] in the [REDACTED] apartment complex. An elderly lady, who identified herself as [REDACTED] answered the door. [REDACTED] lives in the apartment alone and her telephone number is [REDACTED].

I identified myself to [REDACTED] and asked if I could speak to her regarding the shooting incident that occurred in the parking lot behind (east of) her apartment. [REDACTED] seemed to know why I was there, agreed to speak with me and then invited me into her apartment. My conversation with [REDACTED] was tape-recorded.

I asked [REDACTED] to tell me what she knew about the incident. [REDACTED] said she was sitting in her apartment and heard what she thought was a gunshot. [REDACTED] said she then heard three or four more noises that she "knew were shots".

[REDACTED] said after hearing the gunshots, she walked out onto her balcony. From her balcony, [REDACTED] said she saw a guy standing behind a pickup truck and holding what she thought was a rifle. [REDACTED] said she does not know much about guns.

[REDACTED] went on to say that the guy standing behind the truck kept peeking around the side of the bed of the pickup, looking at another guy who was about "halfway into the truck". [REDACTED] explained that the second male subject appeared to be sitting partially in the cab of the pickup, but kept looking back toward the guy standing behind the pickup.

[REDACTED] said that eventually the guy who had been standing behind the pickup moved up toward the cab of the pickup. [REDACTED] then told me, "By that time, apparently the guy (in the cab of the pickup) had already been shot, because he had slumped over into the truck."

[REDACTED] said the guy from behind the pickup moved up to the cab and opened the door. [REDACTED] then changed her statement and said that he didn't open the door. [REDACTED] told me she did

13 DATE / TIME OF REPORT 11/16/06 / 15:16	14 REPORTING OFFICER / ID NO / DIV / UNIT A. Devers #2172 / EC / DETS	15 APPROVED BY / ID NO <i>[Signature]</i> 2186
--	--	---

NARRATIVE REPORT VENTURA COUNTY SHERIFF'S DEPARTMENT

Page 2 of 2 Continuation

AGENCY IDENTIFIER CA0560000

1 RD 9072	2 BEAT 9G	3 RB NUMBER 06-30492
--------------	--------------	-------------------------

4 CODE	5 ITEM	6 QTY	7 ITEM NAME	8 BRAND / MAKE MANUFACTURER	9 MODEL NAME OR NUMBER	10 MISC. DESCRIPTION	11 IDENTIFICATION / SERIAL NUMBER	12 VALUE
--------	--------	-------	-------------	-----------------------------	------------------------	----------------------	-----------------------------------	----------

not want to say anything that wasn't correct. She then said that the guy who had been behind the pickup, moved up to the cab, looked into the window and "saw that the guy (in the cab) was shot." [REDACTED] then told me, "At that point I came in and called 911, because I knew it was something serious."

[REDACTED] told me she thought the incident occurred at about 1830 hours. I went back over [REDACTED]'s statement with her. She showed me that her balcony faces and looks out over the area where the shooting occurred.

[REDACTED] thought she heard four gunshots, but the last three were so close together that there may have been more shots fired. [REDACTED] did not see who did the shooting, but she "presumed" that the guy standing behind the pickup had fired the shots. [REDACTED] said she thought that the guy who had been behind the truck was the person who did the shooting, because it was the guy in the truck who had been shot.

I asked [REDACTED] if she was sure that the guy behind the pickup truck had a rifle. [REDACTED] again told me that she did not know much about guns, however she did go hunting once with her brothers in South Dakota and they used rifles. [REDACTED] said, "It looked like their guns." I asked if the gun was "long". [REDACTED] said, "No, not a long one. No, it wasn't long, so that's why I don't know if it was a rifle or not." I asked [REDACTED] if she could describe the gun. [REDACTED] said, "Well, it was awfully dark and the guy's clothing was dark." [REDACTED] then said, "I would say it was a short rifle." [REDACTED] reached out her hands and gestured that the length of the rifle was about 18 inches long. I asked [REDACTED] if what she saw could have been the guy's arm out-stretched with a handgun in his hand. [REDACTED] said, "It could have been." [REDACTED] then said, "I presumed it was a gun because I heard the shots."

[REDACTED] told me she did not see anyone else in the area. [REDACTED] explained that she was out on her balcony within about 15 seconds after hearing the gunshots and it was approximately a minute later before she saw two other male subjects walk out from the apartment complex to the south of the incident. [REDACTED] said she could not describe any of the subjects, only to say that they were wearing dark clothing. [REDACTED] said she did not hear any words spoken by either subject involved in the incident.

[REDACTED] said she went back into her apartment shortly after seeing the other two male subjects to call 911. When [REDACTED] went back out onto her balcony, emergency personal were starting to arrive. [REDACTED] did not have any additional information to add regarding the incident. Refer to the tape-recording of my conversation with [REDACTED] for more details.

13 DATE / TIME OF REPORT 11/16/06 / 15:16	14 REPORTING OFFICER / ID NO / DIV / UNIT A. Devers #2172 / EC / DETS	15 APPROVED BY / ID NO <i>[Signature]</i> / 2486
--	--	---

NARRATIVE REPORT VENTURA COUNTY SHERIFF'S DEPARTMENT

Page 1 of 2 Continuation

AGENCY IDENTIFIER CA0560000

1 RD 9072	2 BEAT 9G01	3 RB NUMBER 2006-30492
--------------	----------------	---------------------------

4 CODE	5 ITEM	6 QTY	7 ITEM NAME	8 BRAND / MAKE MANUFACTURER	9 MODEL NAME OR NUMBER	10 MISC DESCRIPTION	11 IDENTIFICATION / SERIAL NUMBER	12 VALUE
--------	--------	-------	-------------	-----------------------------	------------------------	---------------------	-----------------------------------	----------

- Supplemental Case Cleared
 Gang Domestic Hate Child Abuse Elderly Abuse

Connecting Report Numbers:

Code Section / Description: 245(c) P.C.

Reclassify to:

Code: S-1 Name: Canley, Adrian



On 11/14/06, at approximately 1840 hours, I arrived at [REDACTED], Thousand Oaks, Ca. I had information that this was the scene of a shooting between Detective Matthews and (S) Adrian Canley. I was asked by Sergeant Powers to interview the firefighters that were still on scene.

Once I completed the interviews with the firefighters, Sergeant Weaver asked me to assist Detectives Harris and Alvarez with a canvas for possible witnesses in the apartments immediately south of the crime scene. Detectives Harris, Alvarez, and I approached and knocked on the door of apartment [REDACTED]. The following is a synopsis of my digitally recorded conversation with [REDACTED]. Refer to the CD for details.

A female adult identified as [REDACTED] answered the knock on her door. Detective Alvarez and I asked if we could speak to her and she invited us into the apartment. [REDACTED] called out for her husband to also come speak with us. Refer to Det. Alvarez's interview with Mr. [REDACTED] for further details. [REDACTED] and I sat in her living room, and she told me the following.

[REDACTED] told me that she had been home from work this evening since approximately 1730 hours. She said she changed her clothes and then lay on her couch. [REDACTED] said she was just about to fall asleep when she heard three loud, "Boom, Boom, Boom." She said she did not go

13 DATE / TIME OF REPORT 11-27-06 / 1112	14 REPORTING OFFICER / ID NO / DIV / UNIT Det. J. Smith/#2569/East County M.C.	15 APPROVED BY / ID NO <i>[Signature]</i> / 1416
---	---	---

NARRATIVE REPORT VENTURA COUNTY SHERIFF'S DEPARTMENT

Page 2 of 2 Continuation

AGENCY IDENTIFIER CA0560000

1 RD 9072	2 BEAT 9G01	3 RB NUMBER 2006-30492
--------------	----------------	---------------------------

4 CODE	5 ITEM	6 QTY	7 ITEM NAME	8 BRAND / MAKE MANUFACTURER	9 MODEL NAME OR NUMBER	10 MISC. DESCRIPTION	11 IDENTIFICATION / SERIAL NUMBER	12 VALUE
--------	--------	-------	-------------	-----------------------------	------------------------	----------------------	-----------------------------------	----------

outside, but her husband immediately went out of the apartment to investigate the sounds that he believed to be gunshots. [REDACTED] said she did not recognize the sounds as that of gunshots. She said she awoke to the sounds sometime after 1800 hours.

[REDACTED] said she did finally go outside to see what the sounds were, and she went down the stairs and stood next to their manager (Mr. [REDACTED]). She saw that the area was already draped with yellow tape. [REDACTED] saw a white truck within the taped-off area, but she did not see anyone on the ground next to the truck. Later, [REDACTED] said that the ambulance had already left the area prior to leaving her apartment. Her first thought was that the truck looked similar to a truck that is driven by a male adult that visits her neighbor, [REDACTED] (Apt. # [REDACTED]). [REDACTED] said she did not know the name of the owner of the truck, but she said the owner of that vehicle "had that gangster look." She said that male was either "Black or Hispanic, or mixed" with a shaved head, 5-10, medium build, in his twenties.

I asked [REDACTED] when she first started to notice the owner of the truck was visiting their complex. She said that person started to visit approximately one week ago, and only had seen that person twice at the complex visiting her neighbor, [REDACTED]. [REDACTED] mentioned that [REDACTED] has an older brother, but she does not know his name. She said that [REDACTED] and his older brother have only lived at the complex a short period of time.

[REDACTED] then informed me of a prior conversation she had with [REDACTED]. During a short conversation with [REDACTED], [REDACTED] asked [REDACTED] the whereabouts of his older brother. [REDACTED] informed [REDACTED], "He's on vacation just like I was." I asked [REDACTED] what she thought [REDACTED] meant by that statement. [REDACTED] said she understood [REDACTED] to mean that the other brother was in jail. [REDACTED] then said from that point on, she felt uncomfortable around [REDACTED] and his friends. After some non-pertinent conversation, I ended the interview.

13 DATE / TIME OF REPORT 11-27-06 / 1112	14 REPORTING OFFICER / ID NO / DIV / UNIT Det. J. Smith/#2569/East County M.C.	15 APPROVED BY / ID NO <i>[Signature]</i> / 2496
---	---	---

NARRATIVE REPORT VENTURA COUNTY SHERIFF'S DEPARTMENT

Page 1 of 2 Continuation

AGENCY IDENTIFIER CA0560000

1 RD 9072	2 BEAT 9G01	3 RB NUMBER 2006-30492
--------------	----------------	---------------------------

4 CODE	5 ITEM	6 QTY	7 ITEM NAME	8 BRAND / MAKE MANUFACTURER	9 MODEL NAME OR NUMBER	10 MISC DESCRIPTION	11 IDENTIFICATION / SERIAL NUMBER	12 VALUE
--------	--------	-------	-------------	-----------------------------	------------------------	---------------------	-----------------------------------	----------

- Supplemental Case Cleared
 Gang Domestic Hate Child Abuse Elderly Abuse

Connecting Report Numbers:

Code Section / Description: 245(c) P.C.

Reclassify to:

Code: S-1 Name: Canley, Adrian



On 11/14/06, at approximately 1840 hours, I arrived at [REDACTED], Thousand Oaks, Ca. I had information that this was the scene of a shooting between Detective Matthews and (S) Adrian Canley. I was asked by Sergeant Powers to interview the firefighters that were still on scene.

Once I completed the interviews with the firefighters, Sergeant Weaver asked me to assist Detectives Harris and Alvarez with a canvas for possible witnesses in the apartments immediately south of the crime scene. I approached and knocked on the door of apartment # [REDACTED]. The following is a synopsis of my digitally recorded conversation with [REDACTED] Refer to the CD for details.

An adult male answered the door and identified himself as [REDACTED], the Apartment Manager. [REDACTED] said he had already given a statement to another detective. I informed [REDACTED] that I wanted to interview his son, since he was home during the incident. [REDACTED] invited me into his apartment and I spoke to his son, [REDACTED], while in [REDACTED]'s presence.

[REDACTED] said he was in the sixth grade, and he was in his apartment when the incident occurred. He said he was eating dinner with his father when he heard "gunshots, and then after that some moaning. And that's pretty much all I heard." I asked [REDACTED] how many gunshots he

13 DATE / TIME OF REPORT 11-24-06 / 1753	14 REPORTING OFFICER / IDNO / DIV / UNIT Det. J. Smith/#2569/East County M.C.	15 APPROVED BY / ID NO <i>[Signature]</i> / 12486
---	--	--

NARRATIVE REPORT VENTURA COUNTY SHERIFF'S DEPARTMENT

Page 2 of 2 Continuation

AGENCY IDENTIFIER CA0560000

1 RD 9072	2 BEAT 9G01	3 RB NUMBER 2006-30492
--------------	----------------	---------------------------

4 CODE	5 ITEM	6 QTY	7 ITEM NAME	8 BRAND / MAKE MANUFACTURER	9 MODEL NAME OR NUMBER	10 MISC. DESCRIPTION	11 IDENTIFICATION / SERIAL NUMBER	12 VALUE
--------	--------	-------	-------------	-----------------------------	------------------------	----------------------	-----------------------------------	----------

heard, and he said, "four to five." I asked him what happened next. [REDACTED] interrupted and said he left the apartment to investigate the gunshots, and he told [REDACTED] to go to his room and stay in the apartment.

[REDACTED] said after a while, he did step outside of the apartment. He said he never went down to look at the scene, but elected to stay on the second story landing by his apartment door. I asked [REDACTED] what he saw from his location. [REDACTED] said he saw a police officer putting up crime scene tape, and lots of lights. He said some trees blocked his view. He said he never went down to the incident. After some non-pertinent conversation, I ended the interview.

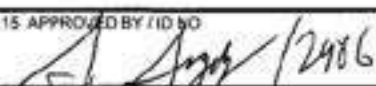
13 DATE / TIME OF REPORT: 11-24-06 / 1753	14 REPORTING OFFICER / ID NO / DIV / UNIT Det. J. Smith/#2569/East County M.C.	15 APPROVED BY / ID NO  / 2486
--	---	--

NARRATIVE REPORT VENTURA COUNTY SHERIFF'S DEPARTMENT

Page 1 of 2 Continuation

AGENCY IDENTIFIER CA0560000

1 RD 9072	2 BEAT 9G01	3 RB NUMBER 2006-30492
--------------	----------------	---------------------------

4 CODE	5 ITEM	6 QTY	7 ITEM NAME	8 BRAND / MAKE MANUFACTURER	9 MODEL NAME OR NUMBER	10 MISC. DESCRIPTION	11 IDENTIFICATION / SERIAL NUMBER	12 VALUE
--------	--------	-------	-------------	-----------------------------	------------------------	----------------------	-----------------------------------	----------

- Supplemental Case Cleared
 Gang Domestic Hate Child Abuse Elderly Abuse

Connecting Report Numbers:

Code Section / Description: 245(c) P.C.

Reclassify to:

Code: S-1 Name: Canley, Adrian



On 11/14/06, at approximately 1840 hours, I arrived at [REDACTED], Thousand Oaks, Ca. I had information that this was the scene of a shooting between Detective Matthews and (S) Adrian Canley. I was asked by Sergeant Powers to interview the firefighters that were still on scene.

Once I completed the interviews with the firefighters, Sergeant Weaver asked me to assist Detectives Harris and Alvarez with a canvas for possible witnesses in the apartments immediately south of the crime scene. Detectives Harris, Alvarez, and I approached and knocked on the door of apartment [REDACTED]. The following is a synopsis of my digitally recorded conversation with the listed parties. Refer to the CD for details.

A female adult identified as [REDACTED] answered the knock on the door. We asked if we could speak to her and [REDACTED] invited us into the apartment. Once in the apartment, we were soon met by two adult males, and two adult females, who came from other rooms of the

13 DATE / TIME OF REPORT 11-24-06 / 1448	14 REPORTING OFFICER / ID NO / DIV / UNIT Det. J. Smith/#2569/East County M.C.	15 APPROVED BY / ID NO <i>[Signature]</i> / 2446
---	---	---

NARRATIVE REPORT VENTURA COUNTY SHERIFF'S DEPARTMENT

Page 2 of 2 Continuation

AGENCY IDENTIFIER CA0560000

1 RD 9072	2 BEAT 9G01	3 RB NUMBER 2006-30492
--------------	----------------	---------------------------

4 CODE	5 ITEM	6 QTY	7 ITEM NAME	8 BRAND / MAKE MANUFACTURER	9 MODEL NAME OR NUMBER	10 MISC DESCRIPTION	11 IDENTIFICATION / SERIAL NUMBER	12 VALUE
--------	--------	-------	-------------	-----------------------------	------------------------	---------------------	-----------------------------------	----------

apartment. I motioned for the two adult females to follow me into the kitchen. I then spoke to (P) [REDACTED] and (P) [REDACTED] who told me the following.

Both (P) [REDACTED] and (P) [REDACTED] said they were friends of the family. They said they knew the [REDACTED] family from when they lived in Canoga Park. They said they lived in the adjacent apartment complex on the same street in Canoga Park. They said they were friends of [REDACTED].

(P) [REDACTED] and (P) [REDACTED] said they drove together to the apartment and arrived at approximately 2000 hours. (P) [REDACTED] said they parked at the intersection of Conejo School Road and Los Feliz Drive, and walked to the apartment (# [REDACTED]). I asked both [REDACTED] and [REDACTED] if they saw or heard what happened that night near the apartment. Both (P) [REDACTED] and (P) [REDACTED] said they did not see or hear what happened that night near the apartment. They both alleged that they arrived at the apartment complex after the shooting had occurred. They had no other information for me. I asked both (P) [REDACTED] and (P) [REDACTED] if they knew the name of (S) Adrian Canley. They both denied knowing (S) Adrian Canley. After some non-pertinent conversation, I ended my conversation.

It is my opinion that both (P) [REDACTED] and (P) [REDACTED] were less than truthful about when they arrived at the apartment complex. I know that the driveway I parked in is the only access into the complex for both vehicles and pedestrians. The driveway was blocked as part of a secondary perimeter when I arrived on scene, and all non-emergency personnel were not allowed to pass through. Since they were both at the apartment, I believe they arrived prior to the shooting and at the very least heard the shooting take place.

13 DATE / TIME OF REPORT 11-24-06 / 1448	14 REPORTING OFFICER / ID NO / DIV / UNIT Det. J. Smith/#2569/East County M.C.	15 APPROVED BY / ID NO <i>[Signature]</i> / 2486
---	---	---

1 CONNECTING REPORT NUMBERS 060030492		2 RD 9072	3 BEAT 9601	4 RB NUMBER 060030499
5 <input type="checkbox"/> CRIME <input checked="" type="checkbox"/> INCIDENT Use Supplemental form to add or change information		6 <input type="checkbox"/> DOMESTIC <input type="checkbox"/> CHILD ABUSE/ HSA <input type="checkbox"/> HATE <input type="checkbox"/> GANG <input type="checkbox"/> ELDERLY ABUSE <input type="checkbox"/> ARRC		
7 CODE SECTION / DESCRIPTION 1 Shots Fired SOC/ Shots fired/Possible shots fired	8 CLASS. <input type="checkbox"/> Misd. <input type="checkbox"/> Fel.	9 CODE SECTION / DESCRIPTION 3	10 CLASS. <input type="checkbox"/> Misd. <input type="checkbox"/> Fel.	
11 CODE SECTION / DESCRIPTION 2	12 CLASS. <input type="checkbox"/> Misd. <input type="checkbox"/> Fel.	13 CODE SECTION / DESCRIPTION 4	14 CLASS. <input type="checkbox"/> Misd. <input type="checkbox"/> Fel.	
15 OCCURRED FROM MO. DAY YR. TIME 11 14 2006 1820	16 DOW TUE	17 OCCURRED TO MO. DAY YR. TIME 11 14 2006 1825	18 DOW TUE	

67 ARSON LOCATION 1234 <input type="checkbox"/> Single Family Res. <input type="checkbox"/> Other Residential <input type="checkbox"/> Storage <input type="checkbox"/> Commercial <input type="checkbox"/> Industrial/Mfg. <input type="checkbox"/> Community/Public <input type="checkbox"/> Other Structure <input type="checkbox"/> Vehicle <input type="checkbox"/> Other Mobile Prop. <input type="checkbox"/> Dumpster/Trash <input type="checkbox"/> Forest/Field <input type="checkbox"/> Other	68 ARSON INHABITED 1234 <input type="checkbox"/> Inhabited <input type="checkbox"/> Uninhabited	69 BURGLARY 1234 <input type="checkbox"/> Residential <input type="checkbox"/> Commercial <input type="checkbox"/> Vehicle <input type="checkbox"/> Other	70 FORCE 1234 <input type="checkbox"/> Force <input type="checkbox"/> No Force <input type="checkbox"/> Attempt Only	75 SPECIAL INTEREST (Copy to Agency/Unit)
71 THEFT <input type="checkbox"/> Auto Parts <input type="checkbox"/> Bicycle <input type="checkbox"/> From Building <input type="checkbox"/> Coin Machine <input type="checkbox"/> From Person <input type="checkbox"/> From Vehicle <input type="checkbox"/> Purse Snatch <input type="checkbox"/> Shoplift <input type="checkbox"/> Other		72 ROBBERY <input type="checkbox"/> Bank <input type="checkbox"/> Commercial <input type="checkbox"/> Convenience Store <input type="checkbox"/> Gas Station <input type="checkbox"/> Highway <input type="checkbox"/> Residence <input type="checkbox"/> Other		73 ASSAULT <input type="checkbox"/> No or Minor injury <input type="checkbox"/> Great Bodily Injury (incl. Potential GBI)
74 WEAPON <input type="checkbox"/> Firearm <input type="checkbox"/> Cutting/Knife <input type="checkbox"/> Hands/Fists/Feet <input type="checkbox"/> Other				76 VALUE/DAMAGE LOSS \$ \$ _____ <small>REPORT ALL INDIVIDUAL PROPERTY, FRAUD, EMBEZZLEMENT AND FORGERY VALUES ON THE PROPERTY/EVIDENCE REPORT</small>

77 DATE AND TIME REPORTED 11/14/2006 1835	78 DATE / TIME OF REPORT 11/14/2006 2256	79 REPORTING OFFICER / ID NO. / DIV. / UNIT DE - Deputy Jones, C. - 3597 - ECPS-THOUSAND OAKS - ECPS THOUSAND OAKS-PATROL
80 FTO OFFICER / ID NO. / DIV. / UNIT		81 APPROVED BY / ID NO. / DIV. / UNIT SGT - Sergeant Sagely, Steven - 2488 - ECPS-INVESTIGATIONS - ECPS THOUSAND OAKS-INVESTIGATIONS

COPIES TO DET / MC NARC GANG/SEU STATS PRESS DOJ COURT OTHER

107 DOMESTIC VIOLENCE (PC 13700, 13701, 13730)

* COMPLETE #70 & 74 ON FRONT PAGE

108 RESPONDED TO A CALL INVOLVING A DOMESTIC INCIDENT.

- Parties involved are described in 13700 (b) PC and
- Incident was verbal only; no evidence of crime, physical violence or traumatic condition existed (brief narrative required) or
- A misdemeanor, other than domestic-related (_____ PC) occurred and no prosecution was desired by any involved party.
- A felony A misdemeanor arrest was made for (_____ PC)

109 RELATIONSHIP OF PARTIES (13700 PC)

- SPOUSES
- FORMER SPOUSES
- COHABITANTS
- FORMER COHABITANT
- DATING/ENGAGED
- FORMER DATING/ENGAGED
- PARENTS OF CHILD FROM RELATIONSHIP

110 13730(G) PC REQUIREMENTS

- (1) Alcohol/Drug use by Abuser? YES NO
- (2) Number of prior responses? _____
- (3) Deputy found it necessary to inquire about the presence of firearms or deadly weapons YES NO
- Inquiry disclosed the presence of firearm(s) or deadly weapon(s). YES NO

111 DOMESTIC VIOLENCE / STALKING / SEX / HATE CRIMES

- Per 264.2 PC, "Victims of Domestic Violence" pamphlet given to: V-1 V-2 V-3 (Includes sexual assault victims)
- Per 6254 GC, Victim of DV, Stalking, Sex or Hate Crime requests his/her name be withheld from the public. V-1 V-2 V-3

NARRATIVE

If Crime Report include a brief description below (establishing elements of crime). Use Narrative Report for details of crime. Document all suspect information on a Suspect Report.

On 11-14-06, at about 1820 hours, I responded to a radio broadcast of shots fired in the area of [REDACTED].

As I arrived on scene, a second call of a suspicious person hiding in the bushes of [REDACTED] was broadcast. [REDACTED] and [REDACTED] have a small section of common property line. The south east section of [REDACTED] is adjacent to the north west section of [REDACTED]. Because the two properties are adjacent, it was believed the suspect in the bushes might have been involved in the incident at [REDACTED].

I went to [REDACTED]. The following is a summary of her tape-recorded statement: On 11-14-06, at about 1820, [REDACTED] was talking on the telephone with a friend and [REDACTED] heard several shots coming from the area of Los Feliz Drive. A couple of minutes went by when [REDACTED] was approached by (W) [REDACTED]. [REDACTED] asked [REDACTED] if she had heard gunshots. [REDACTED] and [REDACTED] decided to walk to the property line and see what was happening. [REDACTED] and [REDACTED] were on the north west side of the property, looking north, when they saw a male subject by the fence of 71 N. [REDACTED] and [REDACTED]. [REDACTED] said the subject appeared to be crouching down near a building at 71 N. [REDACTED] and walking away from [REDACTED].

[REDACTED] went to her trailer and called the police regarding the suspicious person. [REDACTED] said from the time of the gunshots to the time she saw the subject near the building was about five minutes. [REDACTED] was informed by [REDACTED] that the subject had got into a "white Bronco style truck" and quickly left southbound on [REDACTED] and then drove east bound on Thousand Oaks Boulevard.

[REDACTED] could not clearly see the subject but said the subject was definitely male, not black, with short dark hair. The subject was only described as wearing a white shirt.

I then spoke with [REDACTED] and the following is a summary of her tape-recorded statement: On 11-14-06, at about 1825 hours, [REDACTED] was outside her trailer when she heard five gunshots coming from the area of Los Feliz. [REDACTED] said she heard two gunshots, a pause, and then three rapid gunshots. [REDACTED] went to [REDACTED]'s trailer and asked if she had heard the gunshots as well. [REDACTED] and [REDACTED] went to the west side of the property and looked north. [REDACTED] saw a figure crouching down near the

CRIME / INCIDENT REPORT

VENTURA COUNTY SHERIFF'S DEPARTMENT

AGENCY IDENTIFIER CA0560000

Page 3 of 4

(CONTINUED)

1 CONNECTING REPORT NUMBERS

060030492

2 RD

9072

3 BEAT

9G01

4 RB NUMBER

060030499

NARRATIVE (Continued)

block wall and a building on the property of 71 N. [REDACTED]. The figure ran toward the parking lot. [REDACTED] went to the front of the property, near [REDACTED], and saw the subject in the driver seat of a "white Bronco type truck." The subject drove south on [REDACTED], ran the red light at [REDACTED] and Thousand Oaks Boulevard, and continued east on Thousand Oaks Boulevard.

[REDACTED] did not get a good look at the subject, but said he was definitely not black, with short dark hair, wearing a white shirt. [REDACTED] said she is positive the subject in the white car was the same subject she saw near the block wall.

I secured a possible second crime scene at [REDACTED], near the entrance to 71 N. [REDACTED]. I was eventually allowed to move the possible second crime scene into the parking lot of 71 N. [REDACTED]. As I was sitting in the parking lot, a white Chevy Tahoe drove into the parking lot. The driver, (W) Keith [REDACTED], matched the description of the subject seen leaving the area.

I spoke with [REDACTED] and the following is a summary of his tape-recorded statement: [REDACTED] is visiting his friend (P) [REDACTED]. [REDACTED] rents a studio apartment at 71 N. [REDACTED]. On 11-14-06, at about 1820 hours, [REDACTED] was sitting in [REDACTED]'s apartment when [REDACTED] heard five gunshots. [REDACTED] believed the gunshots were being fired in the parking lot directly in front of him, so [REDACTED] "ducked for cover."

After [REDACTED] realized the gunfire was over, he and [REDACTED] cautiously went out into the parking lot. They did not see anybody in the parking lot and went back inside [REDACTED]'s apartment. About 1830 hours, [REDACTED] and [REDACTED] began hearing several sirens in the area and became curious. [REDACTED] and [REDACTED] went outside and saw several emergency lights coming from [REDACTED]. [REDACTED] stood in the parking lot of [REDACTED]'s apartment complex while [REDACTED] walked over to the block wall to see what was happening.

[REDACTED] watched [REDACTED] look over the wall, quickly turn around and began running back toward [REDACTED]. [REDACTED] told [REDACTED] the police were in the apartments and that something must have happened. [REDACTED] was late for a hockey game, so [REDACTED] and [REDACTED] left to go to [REDACTED]'s hockey game. [REDACTED] said [REDACTED] left in a Chevy Tahoe that was almost identical to his.

I then spoke with (P) [REDACTED] and the following is a summary of his tape-recorded statement: [REDACTED] lives at 71 N. [REDACTED]. On 11-14-06, at about 1820, [REDACTED] heard several gunshots and believed they were coming from his parking lot. [REDACTED] went to the parking lot to see if anybody was hurt and did not see anything.

At about 1830 hours, [REDACTED] was on his way to a roller hockey game, when he heard several sirens in the area. [REDACTED] said he saw several flashing lights in the parking lot of [REDACTED] and became "morbidly curious." [REDACTED] walked over to the block wall separating his complex from [REDACTED]. [REDACTED] is 6'4" tall and was the only person tall enough to see over the wall.

[REDACTED] said he looked over the wall, saw several police officers standing around with police tape up. The police officers were looking in his direction and pointing to the block wall. [REDACTED] "got scared" and quickly ducked down. [REDACTED] ran back to the parking lot, got into his friends car and drove away. [REDACTED] did not see the shooting and did not know it was an officer involved shooting until he got back home.

It was apparent to me that [REDACTED] was indeed the subject seen by [REDACTED] and [REDACTED] and that he was not involved in the shooting.

I advised Sergeant Peterson, the incident commander, of the situation. Sergeant Peterson conferred with Major Crimes

CRIME / INCIDENT REPORT

VENTURA COUNTY SHERIFF'S DEPARTMENT

AGENCY IDENTIFIER CA0560000

(CONTINUED)

1 CONNECTING REPORT NUMBERS 060030492	2 RD 9072	3 BEAT 9G01	4 RB NUMBER 060030499
--	--------------	----------------	--------------------------

NARRATIVE (Continued)

Detective Sergeant Ayub, and they agreed that [REDACTED] was not involved in the incident.

I tape-recorded all interviews and booked the micro-cassette into evidence at the East Valley Property Room.

OVERFLOW FIELDS

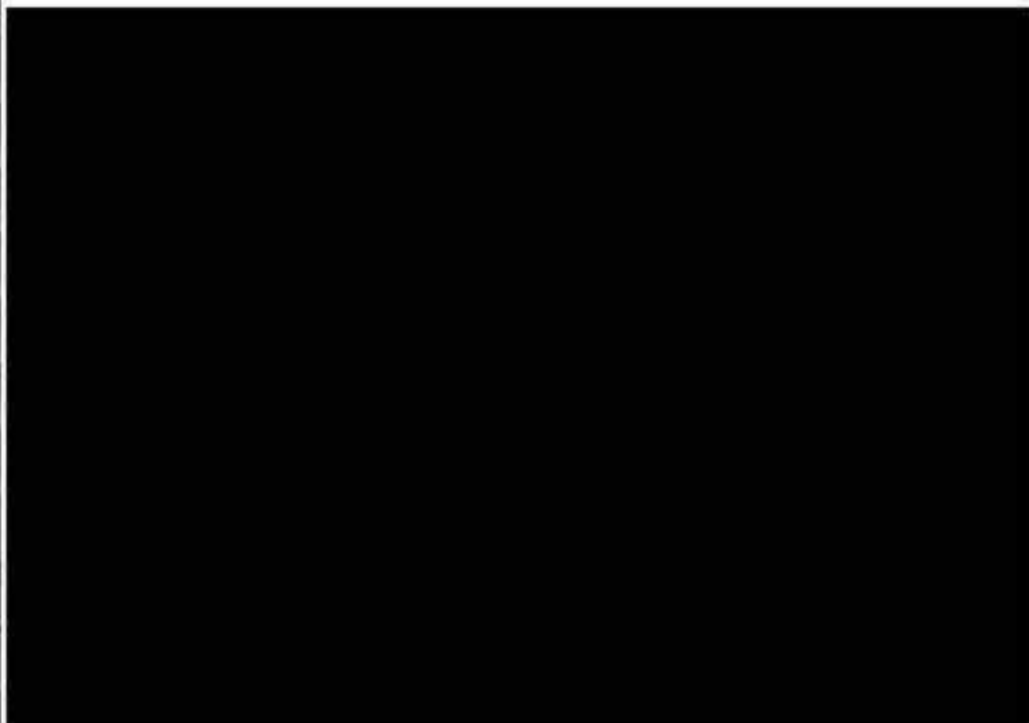

**PROPERTY / EVIDENCE
REPORT**

VENTURA COUNTY SHERIFF'S DEPARTMENT

AGENCY IDENTIFIER CA0560000

1 CONNECTING REPORT NUMBERS 060036492		2 RD 9072	3 BEAT 9001	4 RB NUMBER 060035499
5 INCIDENT / OFFENSE(S) (List all probable cause offenses pertaining to this RB.) Shots Fired SOC/ Shots fired/Possible shots fired / S		6 <input type="checkbox"/> Misdemeanor <input type="checkbox"/> Felony		7 DATE OF INCIDENT 11/14/2006 1820



34 NARRATIVE

Below listed item contains interviews of parties 1-4

PROPERTY/ EVIDENCE INFORMATION

For Bicycles, include the type (boys, girls, road, BMX, etc), frame size (inches), wheel size (inches), number of gears and license nolyty in the Additional Information field.

35 LOCATION BOOKED: Thousand Oaks	36 SEARCH WARRANT? <input type="checkbox"/> Yes <input checked="" type="checkbox"/> No	37 FINDER WISHES TO CLAIM? <input type="checkbox"/> Yes <input checked="" type="checkbox"/> No
--	--	--

38 PROPERTY CLASSIFICATION CODES		PROPERTY CODES			
SP - STOLEN PROPERTY	LP - LOST PROPERTY	A - CURRENCY/NOTES	D - VEHICLES	G - FIREARMS	J - LIVESTOCK
SR - STOLEN/RECOVERED	RC - RECOVERED PROPERTY	B - JEWELRY/PRECIOUS METALS	E - OFFICE EQUIPMENT	H - HOUSEHOLD GOODS	K - MISCELLANEOUS
E - EVIDENCE	FP - FOUND PROPERTY	C - CLOTHING/FURS	F - ELECTRONIC EQUIPMENT	I - CONSUMABLE GOODS	L - RIKE
SK - SAFEKEEPING	T - TRANSACTION	NOTE: ALL VEHICLES SHOULD ALSO BE ENTERED ON A CHP190 REPORT			

CODES E K	ITEM # 1	QTY 1	ITEM NAME Micro-Cassette Tape	MAKE Maxell	MODEL / CALIBER MC-60UR	PROPERTY ROOM USE ONLY
PROP AFFILIATIONS 1, 2, 3		ID / SERIAL NUMBER /			VALUE	
ADDITIONAL INFORMATION of all subjects interviews						

CODES	ITEM #	CITY	ITEM NAME	MAKE	MODEL / CALIBER	PROPERTY ROOM USE ONLY
PROP AFFILIATIONS		ID / SERIAL NUMBER			VALUE	
ADDITIONAL INFORMATION						

39 DATE AND TIME OF REPORT 11/15/2006 0130	40 REPORTING OFFICER / ID NO. / DIV / UNIT DE - Deputy Jones, C. - 3597 - ECPS-THOUSAND OAKS - ECPS THOUSAND OAKS-PATROL
--	--

41 FTO OFFICER / ID NO. / DIV / UNIT	42 APPROVED BY/ ID NO. / UNIT SGT - Sergeant Sagely, Steven - 2485 - ECPS-INVESTIGATIONS - ECPS THOUSAND OAKS-INVESTIGATIONS
--------------------------------------	--

COPIES TO DET/MC NARC GANG/SEU STAB PRESS DOJ COURT OTHER

**PROPERTY / EVIDENCE
REPORT**

VENTURA COUNTY SHERIFF'S DEPARTMENT

PROPERTY CLASSIFICATION CODES

PROPERTY CODES

SP -STOLEN PROPERTY LP-LOSTRPROPERTY
 SR -STOLEN/RECOVERED RC -RECOVERED PROPERTY
 E - EVIDENCE FP - FOUND PROPERTY
 SK - SAFEKEEPING T - TRANSACTION

A - CURRENCY/NOTES
 B - JEWELRY/PRECIOUS METALS
 C - CLOTHING/FURS

D - VEHICLES
 E - OFFICE EQUIPMENT
 F - ELECTRONIC EQUIPMENT

G - FIREARMS
 H - HOUSEHOLD GOODS
 I - CONSUMABLE GOODS

J - LIVESTOCK
 K - MISCELLANEOUS

CODES	ITEM #	QTY	ITEM NAME	MAKE	MODEL / CALIBER	PROPERTY ROOM USE ONLY
PROP AFFILIATIONS			ID / SERIAL NUMBER		VALUE	
ADDITIONAL INFORMATION						
CODES	ITEM #	QTY	ITEM NAME	MAKE	MODEL / CALIBER	PROPERTY ROOM USE ONLY
PROP AFFILIATIONS			ID / SERIAL NUMBER		VALUE	
ADDITIONAL INFORMATION						
CODES	ITEM #	QTY	ITEM NAME	MAKE	MODEL / CALIBER	PROPERTY ROOM USE ONLY
PROP AFFILIATIONS			ID / SERIAL NUMBER		VALUE	
ADDITIONAL INFORMATION						
CODES	ITEM #	QTY	ITEM NAME	MAKE	MODEL / CALIBER	PROPERTY ROOM USE ONLY
PROP AFFILIATIONS			ID / SERIAL NUMBER		VALUE	
ADDITIONAL INFORMATION						
CODES	ITEM #	QTY	ITEM NAME	MAKE	MODEL / CALIBER	PROPERTY ROOM USE ONLY
PROP AFFILIATIONS			ID / SERIAL NUMBER		VALUE	
ADDITIONAL INFORMATION						
CODES	ITEM #	QTY	ITEM NAME	MAKE	MODEL / CALIBER	PROPERTY ROOM USE ONLY
PROP AFFILIATIONS			ID / SERIAL NUMBER		VALUE	
ADDITIONAL INFORMATION						
CODES	ITEM #	QTY	ITEM NAME	MAKE	MODEL / CALIBER	PROPERTY ROOM USE ONLY
PROP AFFILIATIONS			ID / SERIAL NUMBER		VALUE	
ADDITIONAL INFORMATION						
CODES	ITEM #	QTY	ITEM NAME	MAKE	MODEL / CALIBER	PROPERTY ROOM USE ONLY
PROP AFFILIATIONS			ID / SERIAL NUMBER		VALUE	
ADDITIONAL INFORMATION						

7 CONNECTING REPORT NUMBERS 060030492		2 RD 9072	3 BEAT 9G01	4 RB NUMBER 060030499
--	--	--------------	----------------	--------------------------

5 <input type="checkbox"/> CRIME <input checked="" type="checkbox"/> INCIDENT Use Supplemental form to add or change information	6 <input type="checkbox"/> DOMESTIC <input type="checkbox"/> GANG	<input type="checkbox"/> CHILD ABUSE/ HSA <input type="checkbox"/> ELDERLY ABUSE	<input type="checkbox"/> HATE <input type="checkbox"/> ARRC
---	--	---	--

7 CODE SECTION / DESCRIPTION 1 Shots Fired SOC/ Shots fired/Possible shots fired	8 CLASS. <input type="checkbox"/> Misd. <input type="checkbox"/> Fel.	3	9 CODE SECTION / DESCRIPTION	10 CLASS. <input type="checkbox"/> Misd. <input type="checkbox"/> Fel.
11 CODE SECTION / DESCRIPTION 2	12 CLASS. <input type="checkbox"/> Misd. <input type="checkbox"/> Fel.	4	13 CODE SECTION / DESCRIPTION	14 CLASS. <input type="checkbox"/> Misd. <input type="checkbox"/> Fel.

15 OCCURRED FROM MO: 11 DAY: 14 YR: 2006 TIME: 1821	16 DOW TUE	17 OCCURRED TO MO: 11 DAY: 14 YR: 2006 TIME: 1821	18 DOW TUE
--	---------------	--	---------------

19 LOCATION OF OFFENSE / INCIDENT ADDRESS CITY STATE ZIP
2222 Los Feliz Drive, Thousand Oaks, California 91360

20 CODE: V - VICTIM W - WITNESS R - REPORTING PARTY P - PARTY

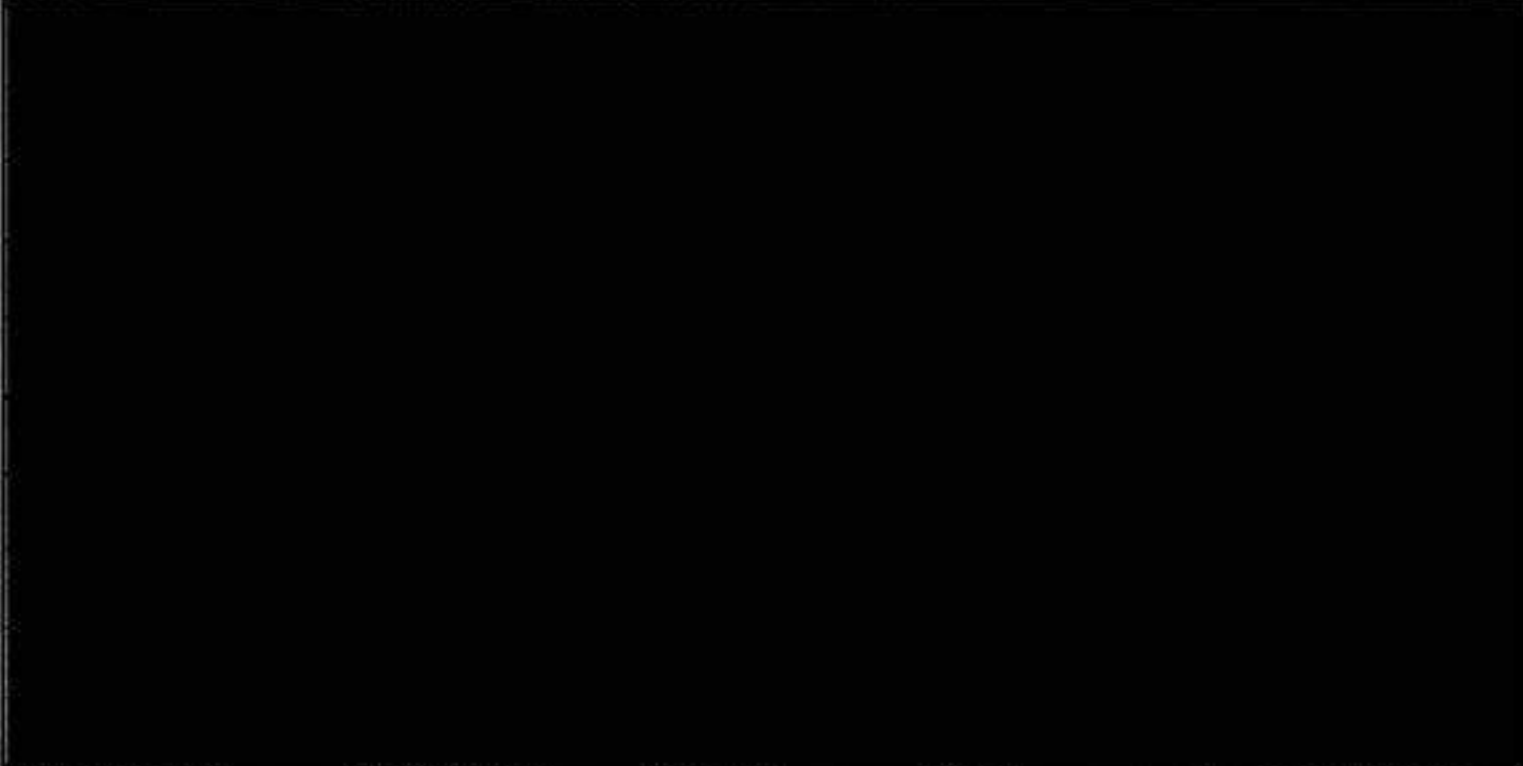

67 ARSON LOCATION 1234 <input type="checkbox"/> Single Family Res. <input type="checkbox"/> Other Residential <input type="checkbox"/> Storage <input type="checkbox"/> Commercial <input type="checkbox"/> Industrial/Mfg. <input type="checkbox"/> Community/Public <input type="checkbox"/> Other Structure <input type="checkbox"/> Vehicle <input type="checkbox"/> Other Mobile Prop. <input type="checkbox"/> Dumpster/Trash <input type="checkbox"/> Forest/Field <input type="checkbox"/> Other	68 ARSON INHABITED 1234 <input type="checkbox"/> Inhabited <input type="checkbox"/> Uninhabited	69 BURGLARY 1234 <input type="checkbox"/> Residential <input type="checkbox"/> Commercial <input type="checkbox"/> Vehicle <input type="checkbox"/> Other	70 FORGE 1234 <input type="checkbox"/> Force <input type="checkbox"/> No Force <input type="checkbox"/> Attempt Only	75 SPECIAL INTEREST (Copy to Agency/Unit)
71 THEFT <input type="checkbox"/> Auto Parts <input type="checkbox"/> Bicycle <input type="checkbox"/> From Building <input type="checkbox"/> Coin Machine <input type="checkbox"/> From Person <input type="checkbox"/> From Vehicle <input type="checkbox"/> Purse Snatch <input type="checkbox"/> Shoplift <input type="checkbox"/> Other	72 ROBBERY <input type="checkbox"/> Bank <input type="checkbox"/> Commercial <input type="checkbox"/> Convenience Store <input type="checkbox"/> Gas Station <input type="checkbox"/> Highway <input type="checkbox"/> Residence <input type="checkbox"/> Other	73 ASSAULT <input type="checkbox"/> No or Minor Injury <input type="checkbox"/> Great Bodily Injury (incl. Potential GB)	74 WEAPON <input type="checkbox"/> Firearm <input type="checkbox"/> Cutting/Knife <input type="checkbox"/> Hands/Fists/Feet <input type="checkbox"/> Other	76 VALUE/DAMAGE LOSS \$ 5

77 DATE AND TIME REPORTED 11/14/2006 1821	78 DATE / TIME OF REPORT 11/14/2006 2150	79 REPORTING OFFICER / ID NO. / DIV. / UNIT DE - Deputy Ferruzza, Paul - 3045 - ECPS-THOUSAND OAKS - ECPS THOUSAND OAKS-PATROL
--	---	---

80 FTO OFFICER / ID NO. / DIV. / UNIT	81 APPROVED BY / ID NO. / DIV. / UNIT S01 - Sergeant Segely, Steven - 2460 - ECPS-INVESTIGATIONS - ECPS THOUSAND OAKS-INVESTIGATIONS
---------------------------------------	---

COPIES TO: DET / MC NARC GANG/SEU STATS PRESS DOJ COURT OTHER

CRIME / INCIDENT REPORT VENTURA COUNTY SHERIFF'S DEPARTMENT

(CONTINUED)

AGENCY IDENTIFIER CA0560000

82 RB NUMBER

060030499

83 ADDITIONAL NAME (Complete Front Page First)													
84 CODE	85 NAME (Last, First, Middle, Gen.) / FIRM NAME			AKA / Moniker	86 RACE	87 SEX	88 HT	89 WT	90 HAIR	91 EYES	92 DOB	93 AGE	
94 VIOLATIONS 1 2 3 4 <input type="checkbox"/> <input type="checkbox"/> <input type="checkbox"/> <input type="checkbox"/>		95 RESIDENCE ADDRESS					CITY	STATE	ZIP	96 RESIDENCE PHONE			
97 BUSINESS/ SCHOOL NAME		ADDRESS			CITY	STATE	ZIP	98 BUSINESS PHONE					
99 OCCUPATION (<input type="checkbox"/> STUDENT <input type="checkbox"/> VC DEPUTY <input type="checkbox"/> OTHER LEO)				100 DAYS OFF	101 WORK HRS	102 INTERPRETER		103 OPERATOR'S LIC. NO. / STATE					
104 VEHICLE LIC. NO. / STATE		105 VEH. COLOR / YEAR /		MAKE /	MODEL /	BODY STYLE		106 OTHER CHARACTERISTICS / VIN NO.					

107 DOMESTIC VIOLENCE (PC 13700, 13701, 13730) * COMPLETE #70 & 74 ON FRONT PAGE

108 RESPONDED TO A CALL INVOLVING A DOMESTIC INCIDENT.		109 RELATIONSHIP OF PARTIES (13700 PC)			110 13730(c) PC REQUIREMENTS		
<input type="checkbox"/> Parties involved are described in 13700 (b) PC <u>and</u> <input type="checkbox"/> Incident was verbal only, <u>no</u> evidence of crime, physical violence or traumatic condition existed (<u>brief narrative required</u>) <u>or</u> <input type="checkbox"/> A misdemeanor, other than domestic-related (_____ PC), occurred <u>and</u> no prosecution was desired by any involved party. <input type="checkbox"/> A felony <input type="checkbox"/> A misdemeanor arrest was made for (_____ PC).		<input type="checkbox"/> SPOUSES <input type="checkbox"/> FORMER SPOUSES <input type="checkbox"/> COHABITANTS <input type="checkbox"/> FORMER COHABITANT <input type="checkbox"/> DATING/ENGAGED <input type="checkbox"/> FORMER DATING/ENGAGED <input type="checkbox"/> PARENTS OF CHILD FROM RELATIONSHIP			(1) Alcohol/Drug use by Abuser? <input type="checkbox"/> YES <input checked="" type="checkbox"/> NO (2) Number of prior responses? _____ (3) Deputy found it necessary to inquire about the presence of firearms or deadly weapons. Inquiry disclosed the presence of firearm(s) or deadly weapon(s). <input type="checkbox"/> YES <input checked="" type="checkbox"/> NO		

111 DOMESTIC VIOLENCE / STALKING / SEX / HATE CRIMES

<input type="checkbox"/> Per 264.2 PC, "Victims of Domestic Violence" pamphlet given to: <input type="checkbox"/> V-1 <input type="checkbox"/> V-2 <input type="checkbox"/> V-3 (Includes sexual assault victims)	<input type="checkbox"/> Per 6254 GC, Victim of DV, Stalking, Sex or Hate Crime requests his/her name be <u>withheld</u> from the public. <input type="checkbox"/> V-1 <input type="checkbox"/> V-2 <input type="checkbox"/> V-3
--	--

NARRATIVE If Crime Report, include a brief descriptor below (establishing elements of crime). Use Narrative Report for details of crime. Document all suspect information on a Suspect Report.

On 11-14-06, at approximately 1615 hours, I was working uniformed patrol in Thousand Oaks. I received a Nextel call from Detective Matthews. He told me that he was at [REDACTED]; he had shots fired, and a subject that was shot. He said he needed back up.

At the same time I received the call from Matthews, dispatch sent two patrol units to a call of shots fired at the same location. Because dispatch did not know that Detective Matthews was involved, I told dispatch via the radio that he was on seen and involved.

Deputy Jones and I were just clearing another call in Newbury Park and responded to the scene. Once we arrived, we both responded to investigate a report of a suspicious subject seen running near the location.

Deputy Jones responded to [REDACTED] See his report for further details. I responded to the area of [REDACTED].

I contacted the resident at [REDACTED] (W) [REDACTED] [REDACTED] told me the following in summary: [REDACTED] was inside her residence when she heard what she thought were two gun shots coming from the north of her house. She looked outside the front widow of her house and did not see anything. She heard the police sirens a short time later. She did not have any further information.

I spoke to the resident at [REDACTED] (W) [REDACTED] [REDACTED] told me the following in summary: [REDACTED] was inside her residence when she heard what she thought were gunshots. She heard three "pops" in rapid secession. There was a short pause and then she heard two more.

[REDACTED] was too scared to look outside. She hid inside her residence. She then heard the police sirens a short time later. She had no further information.

There was no one home at the time of the incident at [REDACTED]

NARRATIVE REPORT VENTURA COUNTY SHERIFF'S DEPARTMENT

Page **1** of **1** Continuation

AGENCY IDENTIFIER CA0560000

1 RD 9072	2 BEAT 9G1	3 RS NUMBER 2006-30492
---------------------	----------------------	----------------------------------

4 CODE	5 ITEM	6 QTY	7 ITEM NAME	8 BRAND / MAKE MANUFACTURER	9 MODEL NAME OR NUMBER	10 MISC. DESCRIPTION	11 IDENTIFICATION / SERIAL NUMBER	12 VALUE
--------	--------	-------	-------------	-----------------------------	------------------------	----------------------	-----------------------------------	----------

- Supplemental** **Case Cleared**
 Gang **Domestic** **Hate** **Child Abuse** **Elderly Abuse**

Connecting Report Numbers:

Code Section / Description: 245(c) PC

Code: (S) **Name:** Canley, Adrian

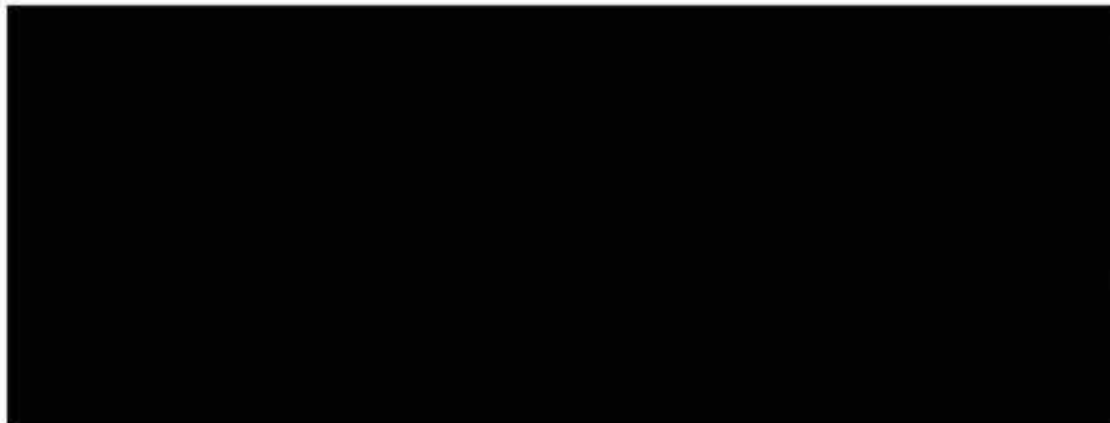

On 11-14-2006, at about 2031 hours, (W) [REDACTED] invited me into her apartment. [REDACTED] told me she lives with her husband, (W) [REDACTED]. This evening, at around 1800 hours, she was watching television with her husband and heard someone knocking on a wall, on her outer porch. [REDACTED] stated she and her husband are "disabled," and she did not get up to investigate what she had heard.

[REDACTED] stated this evening, at around 1900-1930 hours, he heard something outside that sounded like a "big bang." [REDACTED] did not look out the window to investigate what he had heard.

13 DATE / TIME OF REPORT 11/15/06 / 14:50	14 REPORTING OFFICER / ID NO / DIV / UNIT HUTTON / 3438 / ECPS / INVEST	15 APPROVED BY / ID NO <i>[Signature]</i> / 2486
---	---	--

NARRATIVE REPORT VENTURA COUNTY SHERIFF'S DEPARTMENT

Page 1 of 1 Continuation

AGENCY IDENTIFIER CA0560000

1 RD 9072	2 BEAT 9G1	3 RB NUMBER 2006-30492
---------------------	----------------------	----------------------------------

4 CODE	5 ITEM	6 QTY	7 ITEM NAME	8 BRAND / MAKE MANUFACTURER	9 MODEL NAME OR NUMBER	10 MISC. DESCRIPTION	11 IDENTIFICATION / SERIAL NUMBER	12 VALUE
--------	--------	-------	-------------	-----------------------------	------------------------	----------------------	-----------------------------------	----------

- Supplemental** **Case Cleared**
 Gang **Domestic** **Hate** **Child Abuse** **Elderly Abuse**

Connecting Report Numbers:

Code Section / Description: 245(c) PC

Code: (S) **Name:** Canley, Adrian



On 11-14-2006, at about 2026 hours, (W) [REDACTED] invited me into his apartment. [REDACTED] told me this evening, at around 1800 hours, he heard what sounded like a rock being thrown at his window. [REDACTED] said he heard a couple of "quick bangs." [REDACTED] later told me the noise might have been two "shots fired." [REDACTED] was on his computer when he heard the suspicious noises and mentioned he did not get up to investigate what he had heard outside.

13 DATE / TIME OF REPORT 11/15/06 / 14:50	14 REPORTING OFFICER / ID NO / DIV / UNIT HUTTON / 3438 / ECPS / INVEST	15 APPROVED BY / ID NO <i>[Signature]</i> / 2486
---	---	--

NARRATIVE REPORT VENTURA COUNTY SHERIFF'S DEPARTMENT

Page 1 of 3 Continuation

AGENCY IDENTIFIER CA0560000

1 RD 9072	2 BEAT 9G1	3 RB NUMBER 2006-30492
---------------------	----------------------	----------------------------------

4 CODE	5 ITEM	6 QTY	7 ITEM NAME	8 BRAND / MAKE MANUFACTURER	9 MODEL NAME OR NUMBER	10 MISC. DESCRIPTION	11 IDENTIFICATION / SERIAL NUMBER	12 VALUE
--------	--------	-------	-------------	-----------------------------	------------------------	----------------------	-----------------------------------	----------

- Supplemental**
 Case Cleared
 Gang
 Domestic
 Hate
 Child Abuse
 Elderly Abuse

Connecting Report Numbers:

Code Section / Description: 245(c) PC

Code: (S) **Name:** Canley, Adrian

On 11-14-2006, I was working uniformed patrol for the city of Thousand Oaks. At about 1948 hours, I responded to the area of [REDACTED] to assist detectives with an officer-involved shooting investigation. At the direction of Detective Sergeant Weaver #1276, I responded to [REDACTED] to interview elderly residents about the shooting.

[REDACTED] is a full-service, senior citizen apartment community. The apartment complex consists of three floors. The apartments on the east side of the property have windows facing the parking lot of [REDACTED], where the shooting occurred. Deputies Kadosono #3628, and Baker #3152, assisted in interviewing potential witnesses. Refer to their supplemental reports for additional details.

Deputies Kadosono, Baker, and I began interviewing residents on the third floor of the apartment complex. My interviews were digitally recorded. Refer to compact disc containing my interviews for exact details:

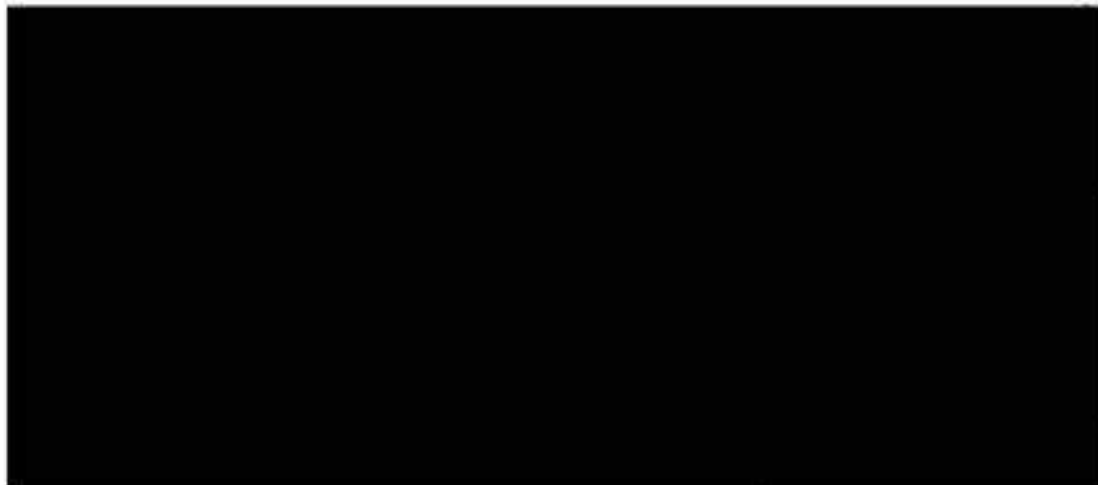

13 DATE / TIME OF REPORT 11/15/06 / 14:44	14 REPORTING OFFICER / ID NO / DIV / UNIT HUTTON / 3438 / ECPS / INVEST	15 APPROVED BY / ID NO <i>[Signature]</i> / 11/16
---	---	---

NARRATIVE REPORT VENTURA COUNTY SHERIFF'S DEPARTMENT

Page 2 of 3 ■ Continuation

AGENCY IDENTIFIER CA0560000

1 RD 9072	2 BEAT 9G1	3 RB NUMBER 2006-30492
---------------------	----------------------	----------------------------------

4 CODE	5 ITEM	6 QTY	7 ITEM NAME	8 BRAND / MAKE MANUFACTURER	9 MODEL NAME OR NUMBER	10 MISC. DESCRIPTION	11 IDENTIFICATION / SERIAL NUMBER	12 VALUE
--------	--------	-------	-------------	-----------------------------	------------------------	----------------------	-----------------------------------	----------

On 11-14-2006, at about 2010 hours, (P) [REDACTED] [REDACTED] invited me into her apartment. I interviewed [REDACTED] and her husband, (P) [REDACTED] [REDACTED]. Neither Wanda nor [REDACTED] saw or heard anything unusual this evening.

[REDACTED]

Apartment complex staff informed me this apartment is currently vacant.

[REDACTED]

On 11-14-2006, at about 2019 hours, (P) [REDACTED] [REDACTED] invited me into her apartment. I interviewed [REDACTED] and she told me she lives alone and did not see or hear anything unusual this evening.

[REDACTED]

At about 2030 hours, I knocked on the door of [REDACTED] [REDACTED]'s apartment. I knew this apartment was rented to [REDACTED] because he name appeared to the right side of her door, above her apartment number. I received no answer at the residence.

[REDACTED]

Apartment complex staff informed me this apartment is currently vacant.

[REDACTED]

On 11-14-2006, at about 2045 hours, I was escorted into (P) [REDACTED] [REDACTED]'s apartment by apartment complex staff. [REDACTED] lives alone and was asleep when I arrived. [REDACTED] stated she went to sleep this

13 DATE / TIME OF REPORT 11/15/06 / 14:44	14 REPORTING OFFICER / ID NO / DIV / UNIT HUTTON / 3438 / ECPS / INVEST	15 APPROVED BY / ID NO <i>[Signature]</i> / 2486
---	---	--

NARRATIVE REPORT VENTURA COUNTY SHERIFF'S DEPARTMENT

Page 3 of 3 Continuation

AGENCY IDENTIFIER CA056C000

1 RD 9072	2 BEAT 9G1	3 RB NUMBER 2006-30492
---------------------	----------------------	----------------------------------

4 CODE	5 ITEM	6 QTY	7 ITEM NAME	8 BRAND / MAKE MANUFACTURER	9 MODEL NAME OR NUMBER	10 MISC DESCRIPTION	11 IDENTIFICATION / SERIAL NUMBER	12 VALUE
--------	--------	-------	-------------	-----------------------------	------------------------	---------------------	-----------------------------------	----------

evening at about 2000 hours. [REDACTED] wears hearing aids and seemed confused while I was questioning her. I terminated my interview with [REDACTED].



On 11-14-2006, at about 2054 hours, (P) [REDACTED] [REDACTED] invited me into her apartment. [REDACTED] lives with her husband, (P) [REDACTED] [REDACTED], who is blind. [REDACTED] told me she did not see or hear anything unusual this evening. [REDACTED] also told me he did not hear anything unusual this evening.



On 11-14-2006, at about 2103 hours, I spoke with (P) [REDACTED] [REDACTED] outside her apartment. [REDACTED] lives alone and told me she did not hear or see anything unusual this evening.

13 DATE / TIME OF REPORT 11/15/06 / 14:44	14 REPORTING OFFICER / ID NO / DIV / UNIT HUTTON / 3438 / ECPS / INVEST	15 APPROVED BY / ID NO <i>[Signature]</i> / 2486
---	---	---

NARRATIVE REPORT VENTURA COUNTY SHERIFF'S DEPARTMENT

Page 4 of 2 Continuation

AGENCY IDENTIFIER CA0560000

1 RD 9072	2 BEAT 9G	3 RB NUMBER 06-30492
--------------	--------------	-------------------------

4 CODE	5 ITEM	6 QTY	7 ITEM NAME	8 BRAND / MAKE MANUFACTURER	9 MODEL NAME OR NUMBER	10 MISC. DESCRIPTION	11 IDENTIFICATION / SERIAL NUMBER	12 VALUE
--------	--------	-------	-------------	-----------------------------	------------------------	----------------------	-----------------------------------	----------

- Supplemental Case Cleared
 Gang Domestic Hate Child Abuse Elderly Abuse

Connecting Report Numbers:

Code Section / Description: Officer Involved Shooting

Code: S-1 Name: Canley, Adrian

On 11-14-06 at about 1930 hours, I responded to the area of [REDACTED] in Thousand Oaks to assist with the investigation of an officer involved shooting incident in which Detective Shane Matthews #3127 shot S-Adrian Canley who was attempting to drive over Detective Matthews with his (Canley's) vehicle.

Once on scene, I assisted several other deputies with a canvas of the area for witnesses. All my conversations with potential witnesses were tape-recorded. I went to the apartment complex located at [REDACTED] and began contacting residents.

On 11-14-06 at about 2010 hours, I contacted [REDACTED] in apartment # [REDACTED] lives alone in the apartment and her telephone number is [REDACTED]. [REDACTED] told me she was home during the time of the shooting, but she did not hear or see anything relating to the incident. [REDACTED] told me she did not even know anything was going on outside, until I knocked on her door to question her.

On 11-14-06 at about 2013 hours, I knocked on the door of apartment # [REDACTED] but received no answer from anyone.

On 11-14-06 at about 2115 hours, I contacted [REDACTED] ([REDACTED]) in apartment # [REDACTED]. [REDACTED]'s telephone number is 805-494-7933. [REDACTED] lives in the apartment with her two sons, [REDACTED] ([REDACTED]) and [REDACTED] ([REDACTED]). I inquired as to what [REDACTED] heard or saw regarding the incident. [REDACTED] told me at about 1830 to 1835 hours, she and her sons were returning home after [REDACTED] picked up the boys from school. They were driving in the area of Conejo School Rd. and Los Feliz Dr., when [REDACTED] said she heard 2 noises that she thought were gunshots, a short pause and then 3 more shots. [REDACTED] said the shots came from the area of her apartment complex, but she was not sure of the exact location. [REDACTED] did not see who was involved in the shooting and she could not provide any additional information regarding the incident.

After I spoke to [REDACTED], I talked to her sons about what they had heard or seen regarding the shooting. [REDACTED] is 5 years old and could not provide any pertinent information. [REDACTED] told me that he was in the family car with [REDACTED] and [REDACTED] on their way home from school. [REDACTED] said when they reached the area of Conejo School Rd. and Los Feliz Dr. he heard 2 "pops" and then 2 more. [REDACTED] explained that he heard 2 initial pops that he thought were gunshots, a short pause and then 2 more shots. [REDACTED] did not know where the shots had come from, or who

13 DATE / TIME OF REPORT 11/15/06 / 11:31	14 REPORTING OFFICER / ID NO / DIV / UNIT A. Devers #2172 / EC / DETS	15 APPROVED BY / ID NO [Signature] / 2986
--	--	--

NARRATIVE REPORT VENTURA COUNTY SHERIFF'S DEPARTMENT

Page 2 of 2 Continuation

AGENCY IDENTIFIER CA0560000

1 RD 9072	2 BEAT 9G	3 RB NUMBER 06-30492
--------------	--------------	-------------------------

4 CODE	5 ITEM	6 QTY.	7 ITEM NAME	8 BRAND / MAKE MANUFACTURER	9 MODEL NAME OR NUMBER	10 MISC DESCRIPTION	11 IDENTIFICATION / SERIAL NUMBER	12 VALUE
--------	--------	--------	-------------	-----------------------------	------------------------	---------------------	-----------------------------------	----------

was doing the shooting. [REDACTED] thought it was about 1830 hours when he heard the shots. [REDACTED] could not provide any additional information regarding the incident.

Following the canvas at [REDACTED], I went to the [REDACTED] which is a senior living complex. [REDACTED] is located [REDACTED]. Once at the complex, I assisted several other deputies with contacting the residents, and attempting to locate any witnesses.

On 11-14-06 between 2050 and 2055 hours, I rang the doorbells of apartments [REDACTED]. I did not get any response from anyone at those four apartments.

On 11-14-06 at about 2056 hours, I rang the doorbell to apartment # [REDACTED] and met with W- [REDACTED] who answered the door. Refer to my additional supplemental report for details of my interview with [REDACTED].

13 DATE / TIME OF REPORT 11/15/06 / 11:31	14 REPORTING OFFICER / ID NO / DIV / UNIT A. Devers #2172 / EC / DETS ^(A)	15 APPROVED BY / ID NO [Signature] / 2486
--	---	--

NARRATIVE REPORT VENTURA COUNTY SHERIFF'S DEPARTMENT

Page 1 of 2 Continuation

AGENCY IDENTIFIER CA0560000

1 RD 9072 2 BEAT 9601 3 RB NUMBER 06-30492

4 CODE	5 ITEM	6 QTY	7 ITEM NAME	8 BRAND / MAKE MANUFACTURER	9 MODEL NAME OR NUMBER	10 MISC DESCRIPTION	11 IDENTIFICATION / SERIAL NUMBER	12 VALUE
--------	--------	-------	-------------	-----------------------------	------------------------	---------------------	-----------------------------------	----------

- Supplemental
 Case Cleared
 Reclassification
 Gang
 Domestic
 Hate
 Child Abuse
 Elderly Abuse
 ARRC

Connecting Report Numbers:

Code Section / Description: 245(a)(1) P.C.

Code: V Name: Mathews, Shane

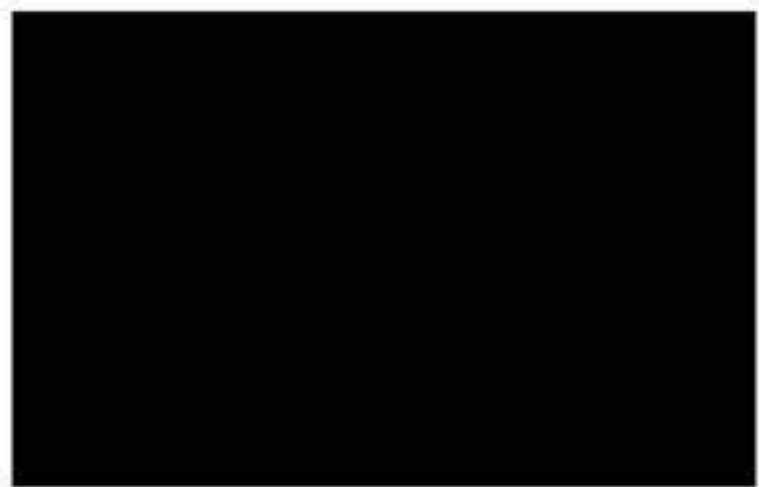

Apartment [Redacted]

2120 hours

The apartment is upstairs (2nd story) and is located to the southwest corner of the complex about 100 yards from the scene.

The following is a synopsis of what [Redacted] told me during a recorded interview on 11/14/2006. He was in his bedroom watching television when he heard some gunshots. He heard two "fast" gunshots, a short pause and then three more gunshots.

13 DATE / TIME OF REPORT 11/16/06 / 11:00	14 REPORTING OFFICER / I/D NO / DIV / UNIT L. Alvarez #2886/ ECPS / DETS	15 APPROVED BY / I/D NO <i>[Signature]</i>
--	---	---

NARRATIVE REPORT VENTURA COUNTY SHERIFF'S DEPARTMENT

Page 2 of 9 Continuation

AGENCY IDENTIFIER CA0560000

1 RD 9072

2 BEAT 9G01

3 RB NUM⁰⁰⁰ 06-30497

4 CODE	5 ITEM	6 QTY.	7 ITEM NAME	8 BRAND / MAKE MANUFACTURER	9 MODEL NAME OR NUMBER	10 MISC. DESCRIPTION	11 IDENTIFICATION / SERIAL NUMBER	12 VALUE
--------	--------	--------	-------------	-----------------------------	------------------------	----------------------	-----------------------------------	----------

Between thirty seconds and one minute later, he walked out of his apartment and towards the staircase. From that location, he could see the parking lot. He noticed a person with a flashlight bending over, near the driver's side of a white truck. He was unable to see well enough from his location. [REDACTED] was unsure if it was a female or a male. He watched for about five minutes from the staircase. He noticed the person with the flashlight was "working" on the person that belonged to the truck. From talking to the neighbors, he later determined the subject with the flashlight was the officer (Detective Mathews) that was involved in the shooting. [REDACTED] could not give me a description of Mathews or a detailed account of what occurred in the area of the truck. [REDACTED] then returned into his apartment to put his shoes on.

[REDACTED] stated he did not hear any words exchanged during the time of the gunshots.

After putting his shoes on, he saw his neighbor with the "ponytail" ([REDACTED] [REDACTED]) run towards the parking lot. [REDACTED] returned about one minute later. He did not know if [REDACTED] was associated with the white truck. [REDACTED] did not see [REDACTED] at the truck when [REDACTED] went towards the parking lot. [REDACTED] initially thought [REDACTED] could be involved in the incident because of his "history". I told [REDACTED] I did not know [REDACTED]'s history. [REDACTED] chose not to elaborate on his comment. [REDACTED] stated [REDACTED] just moved into the apartment and believed he had a friend with a truck like (S) Canley's. [REDACTED] later said he was not positive if [REDACTED] was associated with a white truck.

[REDACTED] stated the slider to his bedroom was closed and there are no windows in the room. [REDACTED] did not have any further information.

The C.D. with the interview was booked into the East County Sheriff's Department property room.

13. DATE / TIME OF REPORT 11/16/06 / 11:00	14. REPORTING OFFICER / ID NO / DIV / UNIT L. Alvarez #2886/ ECPS /DETS	15. APPROVED BY / ID NO  [REDACTED]
---	--	---

NARRATIVE REPORT VENTURA COUNTY SHERIFF'S DEPARTMENT

Page 1 of 3 Continuation

AGENCY IDENTIFIER CA0560000

1 RD 9072

2 BEAT 9601

3 RB NUMRFR 06-30492

4 CODE	5 ITEM	6 QTY	7 ITEM NAME	8 BRAND / MAKE MANUFACTURER	9 MODEL NAME OR NUMBER	10 MSC. DESCRIPTION	11 IDENTIFICATION / SERIAL NUMBER	12 VALUE
--------	--------	-------	-------------	-----------------------------	------------------------	---------------------	-----------------------------------	----------

- Supplemental
 Case Cleared
 Reclassification
 Gang
 Domestic
 Hate
 Child Abuse
 Elderly Abuse
 ARRC

Connecting Report Numbers:

Code Section / Description: 245(a)(1) P.C.

Code: V Name: Mathews, Shane

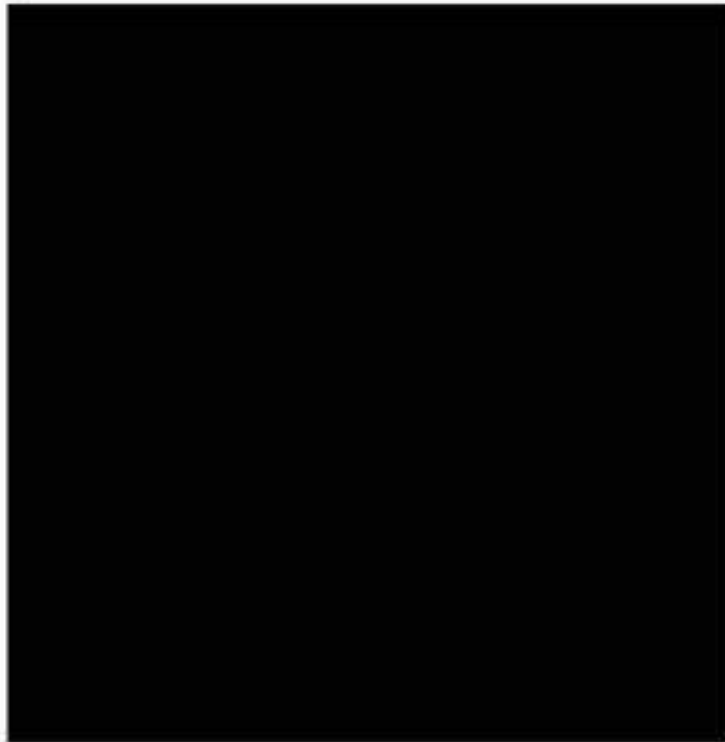

Apartment # [REDACTED]

2007 Hours

The apartment is located to at the southwest corner of the complex and was about 100 yards from the incident.

13. DATE / TIME OF REPORT 11/16/06 / 10:15	14. REPORTING OFFICER / ID NO / DIV / UNIT L. Alvarez #2886/ ECPS /DETS <i>DLA</i>	15. APPROVED BY / ID NO <i>[Signature]</i>
---	---	---

NARRATIVE REPORT VENTURA COUNTY SHERIFF'S DEPARTMENT

Page 2 of 3 Continuation

AGENCY IDENTIFIER CA0560000

1 RD 9072	2 BEAT 9601	3 RB NUMBER 06-30492
--------------	----------------	-------------------------

4 CODE	5 ITEM	6 QTY	7 ITEM NAME	8 BRAND / MAKE MANUFACTURER	9 MODEL NAME OR NUMBER	10 MISC DESCRIPTION	11 IDENTIFICATION / SERIAL NUMBER	12 VALUE
--------	--------	-------	-------------	-----------------------------	------------------------	---------------------	-----------------------------------	----------

The following is a synopsis of what [REDACTED] told me during a recorded interview. She was in her bedroom when she heard at least four gunshots at about 1800 hours. She initially did not realize they were gunshots. She believed it was "something" hitting the walls. About one minute later, she heard people yelling to call the police. She did not hear any voices during the gunshots.

She had her bedroom sliding door open, which faces away from the parking lot. She also had the kitchen window open. The window faces the parking lot. She described the gunshots as coming from the front of the residence. She did not have any further information.

[REDACTED] said her daughter, [REDACTED], was also home at the time. [REDACTED]'s husband was home when I talked to her but she stated he was not home during the incident.

13 DATE / TIME OF REPORT
11/16/06 / 10:15

14 REPORTING OFFICER / ID NO / DIV / UNIT
L. Alvarez #2886 / ECPS / DETS

15 APPROVED BY / ID NO
[Signature]

NARRATIVE REPORT VENTURA COUNTY SHERIFF'S DEPARTMENT

Page 3 of 3 Continuation

AGENCY IDENTIFIER CA0560000

1 RD 2 BEAT 3 RB NUMBER
 9072 9G01 06 3049Z

4 CODE	5 ITEM	6 QTY	7 ITEM NAME	8 BRAND / MAKE MANUFACTURER	9 MODEL NAME OR NUMBER	10 MISC. DESCRIPTION	11 IDENTIFICATION / SERIAL NUMBER	12 VALUE
--------	--------	-------	-------------	-----------------------------	------------------------	----------------------	-----------------------------------	----------

2012 hours

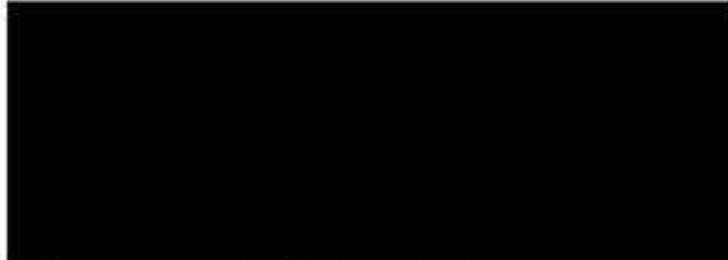

She was in her bedroom doing her homework. She heard a banging sound on the walls and did not know what it was. She opened the window and saw her neighbors, "██████" and "██████", talking outside. She and her mother went outside about two or three minutes after the gunshots. At that time, she saw a white truck "slanted" in the parking lot. She noticed ██████ and ██████ standing on the sidewalk near the parking lot.

When she initially looked out the window, she saw a male subject running towards the area of the parking lot. She then saw him returning in the direction of her apartment. She described him as a male with a ponytail and running with a limp. He was only wearing sweat pants, rolled up. She stated she has seen this subject in the complex before.

She described the suspect as the subject Detective Harris interviewed, ██████ ██████, in apartment #██████.

She heard the gunshots between 1800 hours and 1815 hours. ██████ did not have any further information.

I booked the C.D. with the interviews of ██████ and ██████ into the Sheriff's Department East County property room.

13 DATE / TIME OF REPORT 11/16/06 / 10:18	14 REPORTING OFFICER / ID NO / DIV / UNIT L. Alvarez #2886 / ECPS / DETS	15 APPROVED BY / ID NO <i>[Signature]</i>
--	---	--

NARRATIVE REPORT VENTURA COUNTY SHERIFF'S DEPARTMENT

Page 1 of 4 Continuation

AGENCY IDENTIFIER CA0560000

1 RD 9072	2 BEAT 9G01	3 RB NUMBER 06-30492
--------------	----------------	-------------------------

4 CODE	5 ITEM	6 QTY	7 ITEM NAME	8 BRAND / MAKE MANUFACTURER	9 MODEL NAME OR NUMBER	10 MISC DESCRIPTION	11 IDENTIFICATION / SERIAL NUMBER	12 VALUE
--------	--------	-------	-------------	-----------------------------	------------------------	---------------------	-----------------------------------	----------

- Supplemental Case Cleared
 Gang Domestic Hate Child Abuse Elderly Abuse

Connecting Report Numbers:

Code Section / Description: 245(a)(1) PC / ADW

Reclassify To:

Code: V-1 Name: Matthews, Shane

On 11-14-06, at approximately 1845 hours, I received a call at home from Detective Miller. He told me that Detective Matthews had been involved in a shooting at [REDACTED]. I told him that I would respond to assist with the investigation.

I arrived on scene at approximately 1913 hours. Detective Sergeant Weaver was already on scene and had sent detectives out to canvass the area. I met with Detective Sergeant Ayub and Detective Davidson from the Special Services Division, Major Crimes Bureau. Ayub and Davidson are the case agents for this investigation. Ayub and Davidson requested that the detectives who were canvassing return to the command post for a briefing. Sergeant Weaver and I contacted the detectives who were canvassing and had them return to the command post.

Detective Davidson and Detective Sergeant Powers held the briefing. They gave us information on what they knew regarding the case up to that point and gave specific instructions regarding the neighborhood canvass. Sergeant Weaver was assigned to coordinate the canvass. I went to several residences at [REDACTED] Oaks Boulevard. [REDACTED] is a large, three-story retirement home called the [REDACTED]. We were instructed to attempt to contact all residents who have windows facing east, toward the parking lot where the shooting occurred.

13 DATE / TIME OF REPORT 11-15-06 / 1200	14 REPORTING OFFICER / ID NO / DIV / UNIT SAGELY/2486/EAST COUNTY/MAJOR CRIMES	15 APPROVED BY / ID NO <i>[Signature]</i> 1141 S22
---	---	---

NARRATIVE REPORT VENTURA COUNTY SHERIFF'S DEPARTMENT

Page 2 of 4 Continuation

AGENCY IDENTIFIER CA0560000

1 RD 9072	2 BEAT 9G01	3 RB NUMBER 06-30492
--------------	----------------	-------------------------

4 CODE	5 ITEM	6 QTY	7 ITEM NAME	8 BRAND / MAKE MANUFACTURER	9 MODEL NAME OR NUMBER	10 MISC. DESCRIPTION	11 IDENTIFICATION / SERIAL NUMBER	12 VALUE
--------	--------	-------	-------------	-----------------------------	------------------------	----------------------	-----------------------------------	----------

I first went to the apartments on [REDACTED]. The results of my canvass are as follows:

At approximately 2010 hours, I went to apartment # [REDACTED]. I spoke to [REDACTED] (DOB [REDACTED]), who did not speak very good English. Her daughter, [REDACTED] (10 years old) translated anything [REDACTED] could not understand. The apartment is occupied by [REDACTED], her husband [REDACTED] ([REDACTED]), their daughters [REDACTED], [REDACTED], [REDACTED] ([REDACTED]), [REDACTED] and their son [REDACTED]. [REDACTED] told me that [REDACTED] and [REDACTED] were both still at work and were not home when the shooting occurred. [REDACTED] and her daughters took [REDACTED] to work at Vons in Westlake at approximately 1740 hours and returned home at approximately 1900 hours. The police were on scene when they returned home. Nobody in their household was home when the shooting occurred. The phone number for the [REDACTED] household is [REDACTED].

At approximately 2016 hours I went to apartment # [REDACTED] and spoke with [REDACTED] and his wife, [REDACTED]. They left to go to Best Buy at approximately 1800 hours. They returned home at approximately 1930 hours. They left before the shooting occurred and returned home after the shooting. They told me that they live at the apartment with [REDACTED] father, [REDACTED] his mother, [REDACTED] and his brother, [REDACTED] and [REDACTED] were the only people at the apartment when I contacted them. Both of them were gone when the shooting occurred. They told me that the other three residents were all working when the shooting occurred and were still at work at the time of my contact. The phone number at the apartment is [REDACTED].

At approximately 2018 hours I went to apartment [REDACTED] and knocked loudly several times. I waited for at least a minute, but received no answer at the door.

I learned that the canvass at [REDACTED] had been completed. I then went with several other detectives to contact residents at [REDACTED]. Detective Buschow, Detective Devers, and I covered the second story apartments that have windows facing the parking lot where the shooting occurred.

13 DATE / TIME OF REPORT 11-15-06 / 1200	14 REPORTING OFFICER / ID NO / DIV / UNIT SAGELY/2486/EAST COUNTY/MAJOR CRIMES	15 APPROVED BY / ID NO [Signature] Sst
---	---	---

NARRATIVE REPORT VENTURA COUNTY SHERIFF'S DEPARTMENT

Page 3 of 4 ~~Continuation~~

AGENCY IDENTIFIER CA0560000

1 RD 9072	2 BEAT 9G01	3 RB NUMBER 06-30492
--------------	----------------	-------------------------

4 CODE	5 ITEM	6 QTY	7 ITEM NAME	8 BRAND / MAKE MANUFACTURER	9 MODEL NAME OR NUMBER	10 MISC. DESCRIPTION	11 IDENTIFICATION / SERIAL NUMBER	12 VALUE
--------	--------	-------	-------------	-----------------------------	------------------------	----------------------	-----------------------------------	----------

At approximately 2045 hours I rang the doorbell of apartment [REDACTED] and waited about a minute, but received no answer. There was no nameplate on the door like most of the apartments had, leading me to believe the apartment was unoccupied.

At approximately 2050 hours, I talked to [REDACTED] at apartment [REDACTED]. She told me she is the caregiver for the resident there, [REDACTED] [REDACTED] was in the restroom at the time and unavailable for an interview. [REDACTED] told me that she and [REDACTED] were watching television with a fairly loud volume all evening. They were at the residence the entire day. They did not see or hear anything out of the ordinary. Neither [REDACTED] nor [REDACTED] could remember the phone number of the residence.

At approximately 2052 hours, I went to apartment # [REDACTED] and spoke with the sole resident, [REDACTED]. Her telephone number is [REDACTED]. She said that she never heard any gunshots or any type of disturbance. She did hear sirens earlier in the evening but did not see anything unusual.

At approximately 2053 hours, I went to apartment [REDACTED] and spoke with the sole resident, [REDACTED]. Her telephone number is [REDACTED]. I asked her if she heard any shots or any type of disturbance earlier in the evening. She said that she heard "some popping" but did not know what it was. She estimated it was a little after 1800 hours. She said that she heard three or four pops in rapid succession with no pause in between. She initially did not look out the window and never heard any sirens. Later in the evening she looked out her window and saw the police activity.

At approximately 2055 hours, I went to apartment [REDACTED] and spoke with the sole resident, [REDACTED]. Her telephone number is [REDACTED]. I asked [REDACTED] if she saw or heard anything earlier in the evening. She said that she heard, "two big shots" and thought it came from her porch area. She went and looked out the window and did not see anything

13. DATE / TIME OF REPORT 11-15-06 / 1200	14. REPORTING OFFICER / IDNO / DIV / UNIT SAGELY/2486/EAST COUNTY/MAJOR CRIMES	15. APPROVED BY / IDNO <i>[Signature]</i>
--	---	--

NARRATIVE REPORT VENTURA COUNTY SHERIFF'S DEPARTMENT

Page 4 of 4 Continuation

AGENCY IDENTIFIER CA0560000

1 RD 9072	2 BEAT 9G01	3 RB NUMBER 06-30492
--------------	----------------	-------------------------

4 CODE	5 ITEM	6 QTY.	7 ITEM NAME	8 BRAND / MAKE MANUFACTURER	9 MODEL NAME OR NUMBER	10 MISC. DESCRIPTION	11 IDENTIFICATION / SERIAL NUMBER	12 VALUE
--------	--------	--------	-------------	-----------------------------	------------------------	----------------------	-----------------------------------	----------

unusual. She then saw the police start to arrive in the area. She said she distinctly heard two shots that were loud.

Buschow, Devers, and I completed the interviews on the second story and returned to the command post. We contacted Captain Kelley, who released us from the scene. I left the scene at approximately 2200 hours and returned to the station.

13 DATE / TIME OF REPORT 11-15-06 / 1200	14 REPORTING OFFICER / ID NO / DIV / UNIT SAGELY/2486/EAST COUNTY/MAJOR CRIMES	15 APPROVED BY / ID NO <i>[Signature]</i>
---	---	--

NARRATIVE REPORT VENTURA COUNTY SHERIFF'S DEPARTMENT

Page 1 of 2 Continuation

AGENCY IDENTIFIER CA0560000

9072

95

3 RB NUMBER 06-0030492

4 CODE	5 ITEM	6 QTY	7 ITEM NAME	8 BRAND / MAKE MANUFACTURER	9 MODEL NAME OR NUMBER	10 MISC. DESCRIPTION	11 IDENTIFICATION / SERIAL NUMBER	12 VALUE
--------	--------	-------	-------------	-----------------------------	------------------------	----------------------	-----------------------------------	----------

- Supplemental
 Case Closed
 Reclassification
 Domestic
 Child Abuse
 Hate
 Gang
 Elderly Abuse
 ARRC

Connecting Report Numbers:

Code Section / Description: 245(a)(1) PC
 Code Section / Description (Reclassify To:)

Code: S Name: Canley, Adrian Doyle

On 11-14-06, at about 1930 hours, I responded to [REDACTED] in Thousand Oaks to assist with interviews on an officer involved shooting. At the direction of Sergeant Weaver, I responded to [REDACTED] to interview potential witnesses to the incident.

The building at [REDACTED] is a three-story apartment complex that functions as a primary care facility for senior citizens. The apartments on the east side of the complex have windows that face the courtyard where the incident occurred. Deputies Hutton, Kadosono and I interviewed the occupants on the east side of the third floor. (Refer to Hutton's and Kadosono's reports for details). The following are the tape-recorded interviews with the occupants I contacted:

[REDACTED]

[REDACTED]

Did not see or hear anything.

[REDACTED]

Did not see anything, heard noise but thought it was kids having fun. She could not describe what the noise sounded like.

[REDACTED]

13 DATE / TIME OF REPORT 11/15/2006 9:21 AM	14 REPORTING OFFICER / ID NO / DIV / UNIT B. Baker #3152 / ECPS / SEU	15 APPROVED BY / ID NO. <i>[Signature]</i> 1351
--	--	--

NARRATIVE REPORT VENTURA COUNTY SHERIFF'S DEPARTMENT

Page 2 of 2 Continuation

AGENCY IDENTIFIER CA0560000

1 PC 9072	2 SEAT 9G	3 RB NUMBER 06-0030492
--------------	--------------	---------------------------

4 CODE	5 ITEM	6 QTY	7 ITEM NAME	8 BRAND / MAKE MANUFACTURER	9 MODEL NAME OR NUMBER	10 MSC. DESCRIPTION	11 IDENTIFICATION / SERIAL NUMBER	12 VALUE
--------	--------	-------	-------------	-----------------------------	------------------------	---------------------	-----------------------------------	----------

[REDACTED]

Did not see or hear anything until numerous officers arrived with lights flashing. She then looked out the window and saw a lot of commotion and "streamers." (Streamers = yellow police line).

[REDACTED]

[REDACTED]

Did not see or hear anything, because the television was on and she was eating dinner.

Second Floor

[REDACTED]

Both parties said they were home, but only Esther said she heard what sounded like something hitting a fence. She did not bother to look out the window and did not have any further information.

[REDACTED]

Did not see or hear anything.

[REDACTED]

Sometime between 1500 and 1800 hours, she heard an unusual noise that sounded "like a crash" or something breaking. She did not look out the window and did not have any further information regarding the incident.

I downloaded the digital recordings to a CD, erased my digital recorder and gave the CD to detectives.

13 DATE / TIME OF REPORT 11/15/2006 9:21 AM	14 REPORTING OFFICER / ID NO / DIV / UNIT B. Baker #3152 / ECPS / SEU	15 APPROVED BY (SIGNATURE) <i>[Signature]</i> 1351
--	--	---

NARRATIVE REPORT VENTURA COUNTY SHERIFF'S DEPARTMENT

Page 3 of Continuation

AGENCY IDENTIFIER CA0560000

1 RD 9076	2 BEAT 9G	3 RD NUMBER 06-30492
--------------	--------------	-------------------------

4 CODE	5 ITEM	6 QTY	7 ITEM NAME	8 BRAND / MAKE MANUFACTURER	9 MODEL NAME OR NUMBER	10 MSC. DESCRIPTION	11 IDENTIFICATION / SERIAL NUMBER	12 VALUE
--------	--------	-------	-------------	-----------------------------	------------------------	---------------------	-----------------------------------	----------

- Supplemental
 Case Closed
 Reclassification
 Domestic
 Child Abuse
 Hate
 Gang
 Elderly Abuse
 ARRC

Connecting Report Numbers:

Code Section / Description: 245 (A)(1) P.C./Assault with a Deadly Weapon Code Section / Description (Reclassify To:)

Code: V-1 Name: Matthews, Shane

Source: I am a Senior Deputy assigned to the Special Enforcement / Gang Unit. I responded to the scene of an officer involved shooting that occurred at [REDACTED] Thousand Oaks Ca. I arrived at approximately 1830 hours.

Officer's Actions: Upon my arrival, the crime scene had been secured with the use of crime scene tape. I was first assigned to maintain integrity of the north west side of the crime scene. After approximately 20 minutes, I was redirected from my location and instructed to expand the crime scene approximately thirty yards to the north, in order to give Sheriff's Investigators an inner working perimeter, outside of the immediate area of the crime scene. I maintained integrity of the north entrance to the outer perimeter of the crime scene until I was relieved from this position by Deputy Blanck.

I was then assigned to assist Detective Sgt. Weaver with a canvass of the neighborhood and assigned specific apartments to check on.

Door to Door Canvass: The below narrative is the information that I obtained. The contacts I made during the canvass were recorded on a digital recorder. I later transferred the recordings to a compact disk, turned the compact disk over to detectives and erased the original recording from the recorder.

13 DATE / TIME OF REPORT 11/15/2006 8:47 AM	14 REPORTING OFFICER / ID NO / DIV / UNIT G. MACIAS #2561 / ECPS / SEU	15 APPROVING / ID NO [Signature] 1354
--	---	--

NARRATIVE REPORT VENTURA COUNTY SHERIFF'S DEPARTMENT

Page 2 of 3 Continuation

AGENCY IDENTIFIER CA0560000

1 PD 9076	2 BEAT 9G	3 RB NUMBER 06-30492
--------------	--------------	-------------------------

4 CODE	5 ITEM	6 QTY	7 ITEM NAME	8 BRAND / MAKE MANUFACTURER	9 MODEL NAME OR NUMBER	10 MISC. DESCRIPTION	11 IDENTIFICATION / SERIAL NUMBER	12 VALUE
--------	--------	-------	-------------	-----------------------------	------------------------	----------------------	-----------------------------------	----------



██████████ said he was in his apartment when he heard the sound of four to five gunshots. ██████████ said he had just awoken from a nap and had not heard anything prior to the sound of gunshots. ██████████ said his first reaction was to go to the ground and secure all of the doors and windows to his apartment. ██████████ said that after a short while, he heard the sound of police cars arriving, so he looked outside as two police cars arrived. ██████████ said he looked outside and saw that his roommate, ██████████ arrived after the two police cars.

██████████ did not have any additional information.



██████████ said he was coming home from work and turned into his driveway behind two police cars. ██████████ did not know anything had occurred in the complex until he went into his apartment and talked to his roommate. ██████████ said the only thing his roommate told him was that gunshots were heard, a short time prior to the arrival of the police cars, he did not know any other details.



██████████ was not aware anything had occurred, she had not seen or heard anything unusual. ██████████ said she was alone with her seven year old, daughter ██████████. ██████████ and ██████████ are the only residents that live in this apartment.

13 DATE / TIME OF REPORT 11/15/2006 8:47 AM	14 REPORTING OFFICER / ID NO / DIV / UNIT G. MACIAS #2561 / ECPS / SEU	15 APPROVED BY / ID NO m. [Signature] 135
--	---	--

NARRATIVE REPORT VENTURA COUNTY SHERIFF'S DEPARTMENT

Page 3 of 3 Continuation

AGENCY IDENTIFIER CA0560000

1. RD 9076	2. BEAT 9G	3. RB NUMBER 06-30492
---------------	---------------	--------------------------

4. CODE	5. ITEM	6. QTY	7. ITEM NAME	8. BRAND / MAKE MANUFACTURER	9. MODEL NAME OR NUMBER	10. MISC. DESCRIPTION	11. IDENTIFICATION / SERIAL NUMBER	12. VALUE
---------	---------	--------	--------------	------------------------------	-------------------------	-----------------------	------------------------------------	-----------



[REDACTED] is a three story, senior citizen, assisted living facility located west of [REDACTED] thousand oaks Ca. The facility is staffed with a front desk clerk that has phone access to all of the living quarters.



No answer



[REDACTED] said she was home between the hours of 1800 and 1830 and had not seen or heard anything out unusual.



No answer, the resident name on the door is, [REDACTED]



[REDACTED] works for [REDACTED] as a medical assistant. [REDACTED] said that she was in the basement of the complex dispensing medication between the hours of 1800 and 1830. [REDACTED] was not aware that anything occurred.

13. DATE / TIME OF REPORT 11/15/2006 8:47 AM	14. REPORTING OFFICER / ID NO. / DIV / UNIT G. MACIAS #2561 / ECPS / SEU <i>[Signature]</i>	15. APPROVED BY / ID NO. <i>[Signature]</i> 05061354
---	---	---

NARRATIVE REPORT VENTURA COUNTY SHERIFF'S DEPARTMENT

Page 1 of 1 Continuation

AGENCY IDENTIFIER CA0560000

1 RD **9072** 2 BEAT **9G1** 3 RB NUMBER **06-30492**

4 CODE	5 ITEM	6 QTY	7 ITEM NAME	8 BRAND / MAKE MANUFACTURER	9 MODEL NAME OR NUMBER	10 MISC. DESCRIPTION	11 IDENTIFICATION / SERIAL NUMBER	12 VALUE
--------	--------	-------	-------------	-----------------------------	------------------------	----------------------	-----------------------------------	----------

- Supplemental
 Case Cleared
 Reclassification
 Gang
 Domestic
 Hate
 Child Abuse
 Elderly Abuse
 ARRC

Connecting Report Numbers:

Code Section / Description: Officer involved shooting

Code: S-1 Name: Canley, Adrian Doyle

On 11-14-06, at about 2100 hours, I assisted detectives in canvassing the area of [REDACTED] Oaks Blvd. for possible witnesses to an officer involved shooting that occurred at [REDACTED]. We were instructed to make contact with any residents in the retirement community complex at [REDACTED] Blvd. and determine if anyone had seen or heard what had happened. I attempted to make contact with residents in units [REDACTED] received no answer at these units. I was able to make contact with the following residents at their respective units. All the units share the same address with separate unit numbers. Their statements are as follows:

[REDACTED]

The two said they had been in their residence between 1800 and 1830 hours and had not seen or heard any unusual activity.

[REDACTED]

She said she had been in her residence between 1800 and 1830 hours and had not seen or heard any unusual activity.

[REDACTED]

The two said they had been at dinner between 1800 and 1830 hours and had not seen or heard anything unusual.

13 DATE / TIME OF REPORT 11/14/06 / 23:06	14 REPORTING OFFICER / ID NO / DIV / UNIT S. Collins #3219 / ECPS / 9G11 / Patrol	15 APPROVED BY / ID NO <i>[Signature]</i> 12486
---	---	---

**NARRATIVE/
SUPPLEMENTAL REPORT**

VENTURA COUNTY SHERIFF'S DEPARTMENT

AGENCY IDENTIFIER CA0560000

1 CONNECTING REPORT NUMBERS		2 RD 9072	3 BEAT 9G01	4 RB NUMBER 060030492					
5 <input type="checkbox"/> NARRATIVE <input checked="" type="checkbox"/> SUPPLEMENTAL <input type="checkbox"/> CASE CLOSED									
1 CODE SECTION / DESCRIPTION Officer Involved Shooting		CLASS. <input type="checkbox"/> Misd. <input type="checkbox"/> Fel.	CODE SECTION / DESCRIPTION (<input type="checkbox"/> Reclassify to:)			CLASS. <input type="checkbox"/> Misd. <input type="checkbox"/> Fel.			
CODE S	NAME (Last, First, Middle) / FIRM NAME Canley, Adrian	RACE	SEX	HT	WT	HAIR	EYES	DOB [REDACTED]	AGE 25
RESIDENCE ADDRESS							RESIDENCE PHONE		
OCCUPATION (<input type="checkbox"/> STUDENT <input type="checkbox"/> VC DEPUTY <input type="checkbox"/> OTHER LEO)		DAYS OFF	WORK HOURS	LANGUAGE	OPERATOR'S LIC NO./STATE				
BUSINESS / SCHOOL NAME			ADDRESS				BUSINESS PHONE		
VEH. LIC. NO. / STATE	VEH. COLOR / YEAR / MAKE / MODEL / BODY STYLE			OTHER CHARACTERISTICS / VIN NO.					

Narrative:

On 11-14-06, I was working uniformed patrol in the City of Thousand Oaks (9C). I was requested to conduct interviews of possible witnesses who reside at [REDACTED]. This residence is a senior citizen apartment house and is directly west of the incident location.

I was assigned to the first floor apartments that had windows facing to the east. The following is a list of people that I contacted or attempted to contact and there statements.

[REDACTED]

[REDACTED]

[REDACTED]

[REDACTED]

[REDACTED] stated she was in the community dining room having dinner and did not see or hear anything from that location.

[REDACTED]

These interviews were recorded and the cassette tape was booked into evidence at the East County Property Room.

12 DATE / TIME OF REPORT 11/15/2006 0258		13 REPORTING OFFICER / ID NO. / DIV. / UNIT DE - Deputy Bianck, Daniel - 3755 - ECPS-THOUSAND OAKS - ECPS THOUSAND OAKS-PATROL			
14 FTO OFFICER / ID NO. / DIV. / UNIT		15 APPROVED BY / ID NO. / DIV. / UNIT <i>[Signature]</i> / 7416 / ECPS / DET.			
COPIES TO <input type="checkbox"/> DET / MC <input type="checkbox"/> NARC <input type="checkbox"/> GANG/SEU <input type="checkbox"/> STATS <input type="checkbox"/> PRESS <input type="checkbox"/> DOJ <input type="checkbox"/> COURT <input type="checkbox"/> OTHER					

CRIME / INCIDENT REPORT

VENTURA COUNTY SHERIFF'S DEPARTMENT
AGENCY IDENTIFIER CA0560000

1 CONNECTING REPORT NUMBERS		2 RD 9072	3 BEAT 9601	4 RB NUMBER 060030492
-----------------------------	--	--------------	----------------	--------------------------

5 <input type="checkbox"/> CRIME <input type="checkbox"/> INCIDENT <input checked="" type="checkbox"/> SUPPLEMENTAL	6 <input type="checkbox"/> DOMESTIC <input type="checkbox"/> CHILD ABUSE <input type="checkbox"/> HATE <input type="checkbox"/> GANG <input type="checkbox"/> ELDERLY ABUSE <input type="checkbox"/> ABRC
---	--

7 CODE SECTION / DESCRIPTION (INCIDENT) OFFICER INVOLVED SHOOTING	8 CLASS <input type="checkbox"/> Misd. <input type="checkbox"/> Fel.	9 CODE SECTION / DESCRIPTION (<input type="checkbox"/> Reclassify To:)	10 CLASS <input type="checkbox"/> Misd. <input type="checkbox"/> Fel.
11 CODE SECTION / DESCRIPTION (INCIDENT)	12 CLASS <input type="checkbox"/> Misd. <input type="checkbox"/> Fel.	13 CODE SECTION / DESCRIPTION (<input type="checkbox"/> Reclassify To:)	14 CLASS <input type="checkbox"/> Misd. <input type="checkbox"/> Fel.
15 OCCURRED FROM	16 DOW	17 OCCURRED TO	18 DOW

CITY	STATE	ZIP
THOUSAND OAKS	CA	91362

20 CODE	V - VICTIM	W - WITNESS	R - REPORTING PARTY	F - FINDER	O - OWNER	P - PARTY
---------	------------	-------------	---------------------	------------	-----------	-----------

21 CODE S	22 NAME (Last, First, Middle, Gen.) / FIRM NAME CANEY, ADRIAN	AKA / Moniker	RACE 23	SEX 24	25 HT	26 WT	27 HAIR	28 EYES	29 DOB	30 AGE
--------------	--	---------------	------------	-----------	-------	-------	---------	---------	--------	--------

31 RESIDENCE ADDRESS / (<input type="checkbox"/> Same as Box # _____)	CITY	STATE	ZIP	32 RESIDENCE PHONE ()
---	------	-------	-----	---------------------------

33 BUSINESS / SCHOOL NAME	ADDRESS / (<input type="checkbox"/> Same as Box # _____)	CITY	STATE	ZIP	34 BUSINESS PHONE ()
---------------------------	--	------	-------	-----	--------------------------

35 OCCUPATION (<input type="checkbox"/> STUDENT)	36 DAYS OFF	37 WORK HRS	38 INTERPRETER	39 OPERATOR'S LIC. NO. / STATE
--	-------------	-------------	----------------	--------------------------------

40 VEH. LIC. NO. / STATE	41 VEH. COLOR / YEAR / MAKE / MODEL / BODY STYLE	42 OTHER CHARACTERISTICS / VIN NO.
--------------------------	--	------------------------------------

43 CODE	44 NAME (Last, First, Middle, Gen.) / FIRM NAME	AKA / Moniker	RACE 45	SEX 46	47 HT	48 WT	49 HAIR	50 EYES	51 DOB	52 AGE
---------	---	---------------	------------	-----------	-------	-------	---------	---------	--------	--------

53 RESIDENCE ADDRESS / (<input type="checkbox"/> Same as Box # _____)	CITY	STATE	ZIP	54 RESIDENCE PHONE ()
---	------	-------	-----	---------------------------

55 BUSINESS / SCHOOL NAME	ADDRESS / (<input type="checkbox"/> Same as Box # _____)	CITY	STATE	ZIP	56 BUSINESS PHONE ()
---------------------------	--	------	-------	-----	--------------------------

57 OCCUPATION (<input type="checkbox"/> STUDENT)	58 DAYS OFF	59 WORK HRS	60 INTERPRETER	61 OPERATOR'S LIC. NO. / STATE
--	-------------	-------------	----------------	--------------------------------

62 VEH. LIC. NO. / STATE	63 VEH. COLOR / YEAR / MAKE / MODEL / BODY STYLE	64 OTHER CHARACTERISTICS / VIN NO.
--------------------------	--	------------------------------------

65 ARSON <input type="checkbox"/> Single Family Resid. <input type="checkbox"/> Inhabited <input type="checkbox"/> Uninhabited <input type="checkbox"/> Storage <input type="checkbox"/> Industrial <input type="checkbox"/> Commercial <input type="checkbox"/> Other Structure <input type="checkbox"/> Public Place <input type="checkbox"/> Vehicle <input type="checkbox"/> Unlawful Fire <input type="checkbox"/> Forest <input type="checkbox"/> Injury Occurred <input type="checkbox"/> Other	66 BURGLARY <input type="checkbox"/> Residential <input type="checkbox"/> Vehicle <input type="checkbox"/> Commercial <input type="checkbox"/> Other	67 ROBBERY <input type="checkbox"/> Bank <input type="checkbox"/> Chain Store <input type="checkbox"/> Commercial <input type="checkbox"/> Gas Station <input type="checkbox"/> Highway <input type="checkbox"/> Residence <input type="checkbox"/> Other	68 THEFT <input type="checkbox"/> Auto Parts <input type="checkbox"/> Bicycle <input type="checkbox"/> From Building <input type="checkbox"/> Coin Machine <input type="checkbox"/> From Person <input type="checkbox"/> From Vehicle <input type="checkbox"/> Purse Snatch <input type="checkbox"/> Shoplift <input type="checkbox"/> Other	69 VALUE / DOLLAR LOSS \$ VALUE / DAMAGE LOSS \$	70 FORCE / WEAPON <input type="checkbox"/> No Force <input type="checkbox"/> No Weapon <input type="checkbox"/> Verbal Only <input type="checkbox"/> Attempt Only <input type="checkbox"/> Great Bodily Injury <input type="checkbox"/> Firearm <input type="checkbox"/> Knife <input type="checkbox"/> Hands/Fists/Feet <input type="checkbox"/> Other	71 DOMESTIC VIOLENCE / STALKING / SEX / HATE CRIMES <input type="checkbox"/> Per 264.2 PC, "Victims of Domestic Violence" pamphlet given to: <input type="checkbox"/> VICTIM (Includes sexual assault victims) <input type="checkbox"/> P-1 <input type="checkbox"/> P-2 <input type="checkbox"/> Per 6254 GC, Victim of DV, Stalking, Sex or Hate Crime requests his/her name be withheld from the public. <input type="checkbox"/> YES <input type="checkbox"/> NO	72 SPECIAL INTEREST (Copy to Agency/Unit) <input type="checkbox"/> Domestic Violence <input type="checkbox"/> Sex Crime <input type="checkbox"/> Child Abuse <input type="checkbox"/> HSA <input type="checkbox"/> Gang Related <input type="checkbox"/> Hate Crime <input type="checkbox"/> Agricultural <input type="checkbox"/> Probation <input type="checkbox"/> Parole <input checked="" type="checkbox"/> Other MAJOR CRIMES
---	--	--	---	---	--	---	--

73 DATE AND TIME REPORTED 11-14-06 / 11821	74 DATE / TIME OF REPORT 11-15-06 / 0241	75 REPORTING OFFICER / ID NO. / DIV. / UNIT D. KADOSONO #3678/1855/B	76 APPROVED BY / ID NO. S. Smith 12416
---	---	---	---

77 COPIES TO: <input type="checkbox"/> DET / MC <input type="checkbox"/> NARC <input type="checkbox"/> GANG / SEU <input type="checkbox"/> STATS <input type="checkbox"/> PRESS <input type="checkbox"/> DOJ <input type="checkbox"/> COURT

NARRATIVE REPORT VENTURA COUNTY SHERIFF'S DEPARTMENT

Page ~~16~~ of ~~16~~ Continuation

AGENCY IDENTIFIER CA0560000

1 RD 9072	2 BEAT 9G01	3 RB NUMBER 06-30492
--------------	----------------	-------------------------

4 CODE	5 ITEM	6 QTY	7 ITEM NAME	8 BRAND / MAKE MANUFACTURER	9 MODEL NAME OR NUMBER	10 MISC. DESCRIPTION	11 IDENTIFICATION / SERIAL NUMBER	12 VALUE
--------	--------	-------	-------------	-----------------------------	------------------------	----------------------	-----------------------------------	----------

was aware of in the area were Canley, [REDACTED] and himself. Matthews then said that he had no idea where the Hispanic male was during the incident or where he came from.

I told Detective Matthews that I had a good sense of what took place. I asked the other people in attendance if they would like to route a question to Detective Matthews through me; no one had any additional questions. I explained to Detective Matthews that if I had any follow-up questions for him I would direct them to him through his attorney. I then concluded the interview at 0039 hrs.

End of report.

13 DATE / TIME OF REPORT 01/29/07 2:20 PM	14 REPORTING OFFICER / ID NO / DIV / UNIT Detective R. Davidson#2775/Special Services	15 APPROVED BY / ID NO SGT. W. J. [Signature] 3318
--	--	---

NARRATIVE REPORT VENTURA COUNTY SHERIFF'S DEPARTMENT

Page ~~15~~ of ~~16~~

Continuation

AGENCY IDENTIFIER CA0560000

1 RD 9072	2 BEAT 9G01	3 RB NUMBER 06-30492
--------------	----------------	-------------------------

4 CODE	5 ITEM	6 QTY	7 ITEM NAME	8 BRAND / MAKE MANUFACTURER	9 MODEL NAME OR NUMBER	10 MISC DESCRIPTION	11 IDENTIFICATION / SERIAL NUMBER	12 VALUE
--------	--------	-------	-------------	-----------------------------	------------------------	---------------------	-----------------------------------	----------

described it for the tape. Matthews was wearing a blue button front shirt, tie, slacks and a belt. Attached to his belt was Matthew's badge, gun/holster and handcuffs (in back). Also, around Matthew's neck on a lanyard was his department issued identification card. Matthews commented that except for a jacket, which I had given him to wear (it was after midnight and cold), he was dressed the same as when the incident took place. I asked Detective Matthews if he noticed anything on Canley's person when he was confronting him at the driver's door and/or look for anything on him after pulling him from the vehicle. Matthews said he saw a lighter hanging out of Canley's right pocket, which he pulled out and put on the ground. Matthews then said, "I felt his sweatshirt pockets and in there I found a cell phone. I reached into his left pocket and found 2 black gloves, one of which I believe had a crank pipe in it. I never saw the crank pipe, but I could feel it. I set it aside. I reached under his back as far as I could, but I didn't get all the way. But I couldn't feel anything under his - in the belt line under his back. And his arms, the sleeves of the sweatshirt, but that's about all I - that's all I patted down, just those general areas real quick. And, quite honestly, I wasn't concerned that he was faking, 'cause he had that-his color was fading, his eyes were starting to roll back and I could see his hands clearly; there was nothing in his hands." I interjected, "At that point he wasn't a threat to you." Matthews agreed and added, "Right, I wasn't thinkin' you know - continue searching. It was more to provide some help."

I confirmed there was no one else with Canley at any time during the incident. Matthews said there was not and the only people he

13 DATE / TIME OF REPORT 01/29/07 2:20 PM	14 REPORTING OFFICER / ID NO / DIV / UNIT Detective R. Davidson#2775/Special Services	15 APPROVED BY / ID NO <i>Sgt. W. J. [Signature]</i> 3318
--	--	--

NARRATIVE REPORT VENTURA COUNTY SHERIFF'S DEPARTMENT

Page ~~14~~ of ~~16~~ Continuation

AGENCY IDENTIFIER CA0560000

1 PD 9072	2 BEAT 9G01	3 RB NUMBER 06-30492
--------------	----------------	-------------------------

4 CODE	5 ITEM	6 QTY	7 ITEM NAME	8 BRAND / MAKE MANUFACTURER	9 MODEL NAME OR NUMBER	10 MISC. DESCRIPTION	11 IDENTIFICATION / SERIAL NUMBER	12 VALUE
--------	--------	-------	-------------	-----------------------------	------------------------	----------------------	-----------------------------------	----------

side step. But I was back peddling and I fired two rounds at the truck. I remember staring at the grill and seeing the grill break apart and then the screeching of tires and thinking that he was gonna run me over and that I needed to shoot him in the head, where I could see. I remember saying to myself, shoot what you could see, and all I could see was his head barely over the dash. So I remember I was right on his, where his head was and I fired. I thought it was two rounds, but after counting the rounds at the station it turned out to be three."

I then said, "Tell me, as you're hearing screeches and he's starting to come forward, what - what are you feeling at that point?" Detective Matthews answered, "I'm thinking, I'm gonna get run over. This guys gonna run me over, he's in a big truck and he's gonna do anything he can to get away. And uhm, I, I still remember being in disbelief that I was in front of the truck, cause I couldn't figure out how I got there. But all I knew was that I was there and I was back peddling; and I fired the first two rounds I saw them hit the grill and I told myself that didn't do anything. And I came up to where his head was when he was still coming forward - I remember saying 'stop' really loud a couple of times after the first two rounds, and then, and then he - I remember tires screeching and him coming at me. I fired the three rounds and peeled off and side stepped and then at that point, his foot was definitely off the gas and he just coasted to where the truck is now. He wasn't going at any speed."

I then asked Detective Matthews about the clothing he was wearing when the incident took place. I looked at Matthew's apparel and

13. DATE / TIME OF REPORT 01/29/07 2:20 PM	14. REPORTING OFFICER / ID NO. / DIV / UNIT Detective R. Davidson#2775/Special Services	15. APPROVED BY / ID NO. <i>Sgt. W. J. [Signature]</i> 3318
---	--	--

NARRATIVE REPORT VENTURA COUNTY SHERIFF'S DEPARTMENT

Page 13 of 16 Continuation

AGENCY IDENTIFIER CA0560000

1 RD 9072	2 BEAT 9G01	3 RB NUMBER 06-30492
--------------	----------------	-------------------------

4 CODE	5 ITEM	6 QTY	7 ITEM NAME	8 BRAND / MAKE MANUFACTURER	9 MODEL NAME OR NUMBER	10 MISC. DESCRIPTION	11 IDENTIFICATION / SERIAL NUMBER	12 VALUE
--------	--------	-------	-------------	-----------------------------	------------------------	----------------------	-----------------------------------	----------

remember that he was yelling at me and he was hitting at the window; like trying to keep me from grabbing onto the truck or from grabbing onto him."

I then prompted Matthews to continue by saying, "O.k., he then starts the car." Matthews kept talking saying, "He starts the car, I tried to break the window when he started the car. In my mind, I told myself there's no way he's driving away. Not in his condition. I mean he's - something - I mean he was high. For him to be driving that car around there's no way. So I just remember telling myself, don't let him leave in the truck - don't let him leave in the truck."

Matthews continued, "When I hit the window and it didn't break, I reached for the door and I tried to open the door and that's when he backed out. And I went with the truck - I can't remember if I held on or I just instinctively just followed it out, but when the truck came out, all of a sudden I'm standing in front of it. And I remember saying to myself, 'How did I end up in front of the truck.' I was at the side before and so I started - the whole time I'm yelling, 'Stop, Stop! Sheriff's Department. Stop what you're doing.' You know, and I started walking back, or I started back peddling." Later in the interview, Matthews said that during this time Canley was yelling something unintelligible at him.

I interjected, "Why are you back peddling? Let me ask you that." Matthews said, "Cause he's, he's got the truck started and coming after me. That's what I believe. He's starting to roll forward and he's revving the engine and so I, I don't know why I didn't

13 DATE / TIME OF REPORT 01/29/07 2:20 PM	14 REPORTING OFFICER / ID NO / DIV / UNIT Detective R. Davidson#2775/Special Services	15 APPROVED BY / ID NO <i>Sgt. W. J. [Signature]</i> 3318
--	--	--

NARRATIVE REPORT VENTURA COUNTY SHERIFF'S DEPARTMENT

Page 12 of 16 Continuation

AGENCY IDENTIFIER CA0560000

1 RD 9072	2 BEAT 9G01	3 RB NUMBER 06-30492
--------------	----------------	-------------------------

4 CODE	5 ITEM	6 QTY	7 ITEM NAME	8 BRAND / MAKE MANUFACTURER	9 MODEL NAME OR NUMBER	10 MISC. DESCRIPTION	11 IDENTIFICATION / SERIAL NUMBER	12 VALUE
--------	--------	-------	-------------	-----------------------------	------------------------	----------------------	-----------------------------------	----------

I then asked Detective Matthews to describe in more detail the portion of his statement where he is now chasing Canley and he (Canley) is fumbling with something in his waistband. I further asked Matthews to, "Tell me what you're thinking and what feeling as that is going on. What is your perception of what he's doing?"

Detective Matthews said, "As he's running, he's crouched over and he's reaching with both hands to his front, which I can't see. And he's already told me that I'm not going to take him, that I'm not going to take him alive, so I'm - I assume that he's going for a weapon. That's why I threw my notebook and pulled my gun out as soon as I started running; so that if he were to turn and have a weapon, I would already be up and on target to address that threat. But he never turned towards me and when his hands came out at the truck, I didn't see anything in them. I didn't remember seeing any keys."

Chronologically, we were at the point that Canley was getting into the truck. I asked Detective Matthews how far away he was from Canley as he was getting into the truck. Matthews estimated that he was about 15 feet away. Matthews added that he had not gained any ground on Canley as he chased after him. I then asked Matthews to tell me more about what took place when he arrived at the door and he had his gun pointed at Canley. Matthews said, "I'm yelling at him, Stop! Sheriff's Department, get out of the truck. Let me see your hands. Get out of the truck. Stop. Stop what you're doing." Matthews continued, "And he's yelling back at me, I can't remember specific words, but [pause] I want to say he - I, I can't remember what he was saying. I just

13 DATE / TIME OF REPORT 01/29/07 2:20 PM	14 REPORTING OFFICER / ID NO / DIV / UNIT Detective R. Davidson#2775/Special Services	15 APPROVED BY / AID NO <i>Sgt. W. J. [Signature]</i> 3318
--	--	---

NARRATIVE REPORT VENTURA COUNTY SHERIFF'S DEPARTMENT

Page ~~44~~ of ~~16~~ Continuation

AGENCY IDENTIFIER CA0560000

1 RD 9072	2 BEAT 9G01	3 RB NUMBER 06-30492
--------------	----------------	-------------------------

4 CODE	5 ITEM	6 QTY	7 ITEM NAME	8 BRAND / MAKE MANUFACTURER	9 MODEL NAME OR NUMBER	10 MISC DESCRIPTION	11 IDENTIFICATION / SERIAL NUMBER	12 VALUE
--------	--------	-------	-------------	-----------------------------	------------------------	---------------------	-----------------------------------	----------

I told Matthews that if I got anything wrong he was to correct me. I also told him I would now ask some probing questions about what he was experiencing as he went through the incident. Detective Matthews told me he understood.

I paraphrased Matthew's statement and as I reached portions of the incident, which I wanted to talk more about, I would stop and ask questions of Matthews.

The first question I asked Matthews was concerning the initial statements Canley made to him while he was talking to [REDACTED]. Matthews answered, "I remember that he thought [REDACTED] was a cop too, because he said, 'I know you - I know you guys are Sheriffs and you're not going to get me - or - you're not going to take me.' You know as I think back on it, it was almost challenging, like - 'cause he stood there for a few moments as if he wanted me to respond. And I didn't. I tur-I turned my back on him and went back to talking to [REDACTED], like I didn't want to address it right at that moment."

Matthews continued, "But when he returned then in my mind said, 'something - obviously something's not right this guy needs to be talked to and something - I mean to me - I mean I've had drug training, to me the guy was, was high on meth or coke or some kind of stimulant. Couldn't - you know he was pacing back and forth - he couldn't hold still. Honestly, he had that meth paranoia almost going. You know how they get, like everybody's after him. That's how it seemed like, he thought I was after him and yet, I didn't even know who the guy was."

13 DATE / TIME OF REPORT 01/29/07 2:20 PM	14 REPORTING OFFICER / ID NO / DIV / UNIT Detective R. Davidson#2775/Special Services	15 APPROVED BY / ID NO Sgt. W. J. [Signature] 3318
--	--	---

NARRATIVE REPORT VENTURA COUNTY SHERIFF'S DEPARTMENT

Page ~~40~~ of ~~16~~ Continuation

AGENCY IDENTIFIER CA0560000

1 RD 9072	2 BEAT 9G01	3 RB NUMBER 06-30492
--------------	----------------	-------------------------

4 CODE	5 ITEM	6 QTY	7 ITEM NAME	8 BRAND / MAKE MANUFACTURER	9 MODEL NAME OR NUMBER	10 MISC DESCRIPTION	11 IDENTIFICATION / SERIAL NUMBER	12 VALUE
--------	--------	-------	-------------	-----------------------------	------------------------	---------------------	-----------------------------------	----------

with him at the Air Unit, so I know he is capable of doing it. And I said, 'It's probably a good idea.'"

Detective Matthews said he walked with Deputy Hall to the west where the entrance to the parking area begins. Deputy Hall asked Matthews how big the Crime Scene needed to be. Detective Matthews said he helped place the crime scene tape around the area. Additional, patrol units began to arrive. Detective Matthews told the arriving deputies that [REDACTED] had seen the entire incident and he also mentioned the Hispanic man he had contacted earlier.

About ten minutes later, Detective Matthews was standing with Deputy Ferruzza, who had been assigned to stay with him, when he (Matthews) looked down and saw that his digital audio recorder was on and had been on during the entire incident. Detective Matthews looked at the recorder and saw that it had been running for, "50 something minutes." Matthews said he knew that this would include [REDACTED]'s interview and the shooting. Detective Matthews then said, "So I turned it off in front of Paul [Ferruzza], or I stopped the recording - I turned it off and I gave it to him and I told him, 'You better hold onto this, its got the whole shooting on the tape.'"

Detective Matthews said he then sat in the car and waited. Up until this point in the walk-through, I had asked very few questions. It was my intention to obtain Detective Matthews initial statement unfettered. I told Detective Matthews that I now wanted to walk him back through what he had said to ensure that I had a clear and accurate picture of what he had told us.

13 DATE / TIME OF REPORT 01/29/07 2:20 PM	14 REPORTING OFFICER / ID NO / DIV / UNIT Detective R. Davidson#2775/Special Services	15 APPROVED BY / ID NO Sgt. W. J. [Signature] 3318
--	--	---

NARRATIVE REPORT VENTURA COUNTY SHERIFF'S DEPARTMENT

Page 9 of 16

Continuation

AGENCY IDENTIFIER CA0560000

1 RD 9072	2 BEAT 9G01	3 RB NUMBER 06-30492
---------------------	-----------------------	--------------------------------

4 CODE	5 ITEM	6 QTY	7 ITEM NAME	8 BRAND / MAKE MANUFACTURER	9 MODEL NAME OR NUMBER	10 MISC. DESCRIPTION	11 IDENTIFICATION / SERIAL NUMBER	12 VALUE
--------	--------	-------	-------------	-----------------------------	------------------------	----------------------	-----------------------------------	----------

the right side. At this point, Deputy Berg arrived and used a pair of medical scissors to cut the sweatshirt and underlying T-shirt off of Canley.

Detective Matthews said that once the clothing was off, he was able to see the bullet hole in the upper right portion of Canley's chest. Matthews continued, "By this time, he was -- eyes were starting to roll back, there was no response, his breathing was shallow; although he still had a carotid pulse but he had no radial pulse (Wrist)." I stopped Det. Matthews and pointed out that his description of Canley's condition seemed beyond basic first aid. I also stated for the tape and others, that I knew that he (Matthews) had more advanced medical training than first aid and I asked him to review his background for us. Detective Matthews stated that he was an Emergency Medical Technician (EMT) and worked at the Sheriff's Air Unit. He has responded on numerous medical flights. Prior to his employment with the Sheriff's Department, Matthews said he worked for Community Memorial Hospital in both the Surgery Unit and the Emergency Room as an Emergency Medical Technician.

Detective Matthews then continued telling us what took place after the shooting. Matthews said he checked for a radial pulse and found none; he checked Canley's carotid pulse on both sides of his neck and found that he had a pulse. Detective Matthews then said, "I got out the pocket mask. I gave him 2 or 3 breaths to assist his breathing, 'cause it was pretty shallow." At this point, Deputy Berg suggested that he be allowed to handle Canley's medical care. Matthews said, "Berg is an EMT and I work

13 DATE / TIME OF REPORT 01/29/07 2:20 PM	14 REPORTING OFFICER / ID NO / DIV / UNIT Detective R. Davidson#2775/Special Services	15 APPROVED BY / ID NO <i>SGT. W. J. [Signature]</i> 3318
---	---	---

NARRATIVE REPORT VENTURA COUNTY SHERIFF'S DEPARTMENT

Page 8 of 16 Continuation

AGENCY IDENTIFIER CA0560000

1 RD 9072	2 BEAT 9G01	3 RB NUMBER 06-30492
--------------	----------------	-------------------------

4 CODE	5 ITEM	6 QTY	7 ITEM NAME	8 BRAND / MAKE MANUFACTURER	9 MODEL NAME OR NUMBER	10 MISC DESCRIPTION	11 IDENTIFICATION / SERIAL NUMBER	12 VALUE
--------	--------	-------	-------------	-----------------------------	------------------------	---------------------	-----------------------------------	----------

Detective Matthews holstered his weapon and pulled Canley out of the truck and onto the ground. Detective Matthews said he then opened Canley's airway. During this time he could hear the sirens of a couple patrol cars going by the entrance to the apartment complex. Matthews told Canley to keep breathing and not to move. Matthews described Canley's breathing and said, "He was moaning on his exhales but nothing else."

At this point, Detective Matthews said two things happened and he was unsure which happened first; he ran over to the driveway and flashed his light at the patrol cars to get their attention and a, "smaller Hispanic male" ran over and asked what was going on. Det. Matthews asked the man if he knew Canley; the man said he did not. Det. Matthews directed the man to stand with [REDACTED] (the person he was interviewing earlier). Det. Matthews then said he thought he talked to the man first and then flashed his light at the patrol cars.

Deputies Natoli and Hall arrived. They asked Matthews if he was alright and if there were any outstanding suspects; Matthews told them he was fine and there were no other suspects. They then asked Detective Matthews what he needed. He told them he needed a first aid kit, gloves and for someone to put up crime scene tape to protect the scene.

Detective Matthews put on the gloves and retrieved some pressure dressings. He asked Deputy Natoli to cut Canley's sweatshirt off of him. Detective Matthews was specific in telling Deputy Natoli to cut the left side of the sweatshirt, because the blood was on

13 DATE / TIME OF REPORT 01/29/07 2:20 PM	14 REPORTING OFFICER / ID NO / DIV / UNIT Detective R. Davidson#2775/Special Services	15 APPROVED BY / ID NO SGT. W. J. [Signature] 3318
--	--	---

NARRATIVE REPORT VENTURA COUNTY SHERIFF'S DEPARTMENT

Page 7 of 16 Continuation

AGENCY IDENTIFIER CA0560000

1 RD 9072	2 BEAT 9G01	3 RB NUMBER 06-30492
--------------	----------------	-------------------------

4 CODE	5 ITEM	6 QTY	7 ITEM NAME	8 BRAND / MAKE MANUFACTURER	9 MODEL NAME OR NUMBER	10 MISC. DESCRIPTION	11 IDENTIFICATION / SERIAL NUMBER	12 VALUE
--------	--------	-------	-------------	-----------------------------	------------------------	----------------------	-----------------------------------	----------

you do this? Or, what were you doing? Or something to that effect."

Det. Matthews said he yelled to [REDACTED], the person he had just interviewed, to call 911 because he did not have a radio with him. Matthews said he was crouched down behind the tailgate of the truck on the driver's side of the truck. He was going through his Nextel phone trying to find someone who could respond to help him. Det. Matthews said he was eventually able to reach Deputy Paul Ferruzza, who was working patrol shift 9041. Matthews told Ferruzza his location, shots had been fired and requested code three (lights and siren) assistance immediately. Deputy Ferruzza acknowledged Matthews and hung up. At about the same time, [REDACTED] asked Matthews for his last name so he could provide it to the dispatcher.

During this time, Canley was yelling, "You shot me. I'm hit." He was also moaning. Deputy Matthews worked his way over to his vehicle and retrieved a flashlight and went back to the tailgate. He shone his flashlight into the interior of the truck. The driver's door was open as Canley had opened the door. Matthews said he could see a portion of Canley's shoulder and head. Detective Matthews said that by this time, Canley had stopped talking and was now moaning. Matthews continued to tell Canley to show his hands and he began to approach Canley. When Matthews arrived at the driver's door he could see that Canley's body was slouched down. Detective Matthews said he could see some blood on the front of Canley's sweatshirt. Matthews commented that Canley had the "I'm dying look and he was moaning. I've seen it before."

13 DATE / TIME OF REPORT 01/29/07 2:20 PM	14 REPORTING OFFICER / ID NO / DIV / UNIT Detective R. Davidson#2775/Special Services	15 APPROVED BY / ID NO Sgt. W. J. [Signature] 3318
--	--	---

NARRATIVE REPORT VENTURA COUNTY SHERIFF'S DEPARTMENT

Page 6 of 16

Continuation

AGENCY IDENTIFIER CA0560000

1 RD 9072	2 BEAT 9G01	3 RB NUMBER 06-30492
--------------	----------------	-------------------------

4 CODE	5 ITEM	6 QTY.	7 ITEM NAME	8 BRAND / MAKE MANUFACTURER	9 MODEL NAME OR NUMBER	10 MISC. DESCRIPTION	11 IDENTIFICATION / SERIAL NUMBER	12 VALUE
--------	--------	--------	-------------	-----------------------------	------------------------	----------------------	-----------------------------------	----------

Det. Matthews continued to explain what was taking place saying, "So, I'm in front of the truck. I started back pedaling to get away from the truck. He (Canley) started coming forward. I fired two rounds at the truck - at the truck that was coming at me. I don't remember hearing the-I don't remember hearing the gunshots, but I remember star - I was staring at the grill of the truck as it was coming; and that's exactly where the shots went. And I knew my gun had fired because of the recoil and the pieces of the grill kind of went flying, or you know, broke apart. I yelled stop again. I was still - as this is going on, I'm still walking backwards."

Det. Matthews showed us how he moved backwards and at this time he indicated that he had moved north to an area in front of the second parking stall from the planter area referred to above. Matthews continued, "He revved the engine. I heard the tires squeal and - I mean it happened - it felt like it was in slow motion but I know it was, it was super quick. It was boom, boom, 'Stop! Stop!' and then [squealing noise] and then boom, boom, boom. I remember specifically looking right as his head that was in the windshield and aiming at his head when I fired.

Matthews described how he saw the rounds strike the area where the windshield meets the dashboard. Matthews again continued saying, "As he's coming at me, I fired the rounds and peeled off and he was yelling, 'You shot me. I'm hit.' And then the truck just slowly rolled forward and it stopped where you see it now."

Det. Matthews ran up to the back of the truck and yelled for Canley not to move. Matthews also instructed Canley to show his hands. Matthews then yelled to Canley, "Who are you? Why did

13 DATE / TIME OF REPORT 01/29/07 2:20 PM	14 REPORTING OFFICER / ID NO / DIV / UNIT Detective R. Davidson#2775/Special Services	15 APPROVED BY / ID NO Sgt. W. J. [Signature] 3318
--	--	---

NARRATIVE REPORT VENTURA COUNTY SHERIFF'S DEPARTMENT

Page 5 of 16 Continuation

AGENCY IDENTIFIER CA0560000

1 RD 9072	2 BEAT 9G01	3 RB NUMBER 06-30492
--------------	----------------	-------------------------

4 CODE	5 ITEM	6 QTY	7 ITEM NAME	8 BRAND / MAKE MANUFACTURER	9 MODEL NAME OR NUMBER	10 MISC. DESCRIPTION	11 IDENTIFICATION / SERIAL NUMBER	12 VALUE
--------	--------	-------	-------------	-----------------------------	------------------------	----------------------	-----------------------------------	----------

and shouted, "Sheriff's Department, stop. Get out of the truck. Get out of the truck." The window was half down and Det. Matthews remembered trying to grab the window but said that Canley kept hitting the window, trying to keep his hands off. Matthews tried to break the window twice by hitting it with the "nose" of his gun. The window did not break.

By this time, Canley had the pickup's engine started. Matthews told us, "I grabbed the driver handle [sic] and he backed out quickly. So when he backed out, I kinda went with, I went with the truck; not on purpose but kinda just - it kinda pulled me out." Matthews motioned and showed us that the tail end of the truck was now nearest the apartment building and the front of the truck was to the north. Matthews continued, "So the-I'm on the-I'm in front of the truck but more toward the driver's side. I said to myself, 'How did you end -- I'm thinking how did I end up in front of the truck, 'cause I didn't intentionally end up in front of the truck. Just the way the truck came out and me holding on, I just ended up here."

Det. Matthews said he continued to yell at Canley to stop the "whole time." Matthews started backing up. Matthews then made the observation that Canley was yelling at him (Matthews) the whole time through the window. Canley was yelling, "Fuck you" and other things that Matthews could not specifically recall, but Matthews had the impression that "he was pretty pissed off." I asked Matthews if it was the tone of Canley's voice that told him he was pissed off. Matthews said it was.

13 DATE / TIME OF REPORT 01/29/07 2:20 PM	14 REPORTING OFFICER / ID NO / DIV / UNIT Detective R. Davidson#2775/Special Services	15 APPROVED BY / ID NO <i>Sgt. W. J. [Signature]</i> 3318
--	--	--

NARRATIVE REPORT VENTURA COUNTY SHERIFF'S DEPARTMENT

Page 4 of 16 Continuation

AGENCY IDENTIFIER CA0560000

1 RD 9072	2 BEAT 9G01	3 RB NUMBER 06-30492
--------------	----------------	-------------------------

4 CODE	5 ITEM	6 QTY	7 ITEM NAME	8 BRAND / MAKE MANUFACTURER	9 MODEL NAME OR NUMBER	10 MISC. DESCRIPTION	11 IDENTIFICATION / SERIAL NUMBER	12 VALUE
--------	--------	-------	-------------	-----------------------------	------------------------	----------------------	-----------------------------------	----------

for him and he knew I was the Sheriff. He's sayin, 'Fuckin' Sheriff ain't going to take me alive.' So, I was going to contact him and he immediately bolted."

With that said I suggested that we move to the area Det. Matthews was now referring to in his explanation of what took place. We ended up at the base of the stairs of [REDACTED] Det. Matthews told us that as soon as he stepped off the raised cement landing he was on and took a couple of steps, Canley took off running northbound on the sidewalk along the west edge of the parking lot. Det. Matthews said he chased after Canley. When Det. Matthews reached the intersection of the walkways that crossed the area, he noticed Canley started fumbling with something and reaching into the front of his waistband or sweatshirt area. Det. Matthews pointed out that Canley had already made a statement about not being taken alive, and he indicated that Canley was running away from him and therefore had his back to him. Det. Matthews said that as he was running, he threw his notebook to the ground.

We then walked along the path in the direction Det. Matthews chased Canley. Matthews told us he saw Canley reaching toward his waistband and when he (Matthews) reached the intersection of the walkways he drew his firearm with his left hand (he is left handed) and threw his notebook to the ground. Matthews was telling Canley to stop saying, "Sheriff's Department stop." Canley's vehicle, a white pickup, was parked in the 3rd parking space south of a planter which created a portion of the entrance to the parking lot. The pickup was parked "nose in." Canley got into the car. Det. Matthews ran up to the door with his gun out

13 DATE / TIME OF REPORT 01/29/07 2:20 PM	14 REPORTING OFFICER / ID NO / DIV / UNIT Detective R. Davidson#2775/Special Services	15 APPROVED BY / ID NO Sgt. W. J. [Signature] 3318
--	--	---

NARRATIVE REPORT VENTURA COUNTY SHERIFF'S DEPARTMENT

Page 3 of 16 Continuation

AGENCY IDENTIFIER CA0560000

1 RD 9072	2 BEAT 9G01	3 RB NUMBER 06-30492
--------------	----------------	-------------------------

4 CODE	5 ITEM	6 QTY	7 ITEM NAME	8 BRAND / MAKE MANUFACTURER	9 MODEL NAME OR NUMBER	10 MISC. DESCRIPTION	11 IDENTIFICATION / SERIAL NUMBER	12 VALUE
--------	--------	-------	-------------	-----------------------------	------------------------	----------------------	-----------------------------------	----------

[For ease of reading, I will refer to Canley by name. However, it should be noted that Detective Matthews did not know Canley's name during this incident.]

Det. Matthews turned around and saw Canley; Matthews described Canley and his clothing in a manner consistent with Canley's physical description and clothing. Canley was pacing back and forth and moving his hands in an animated manner. According to Matthews, Canley was "mad dogging" him. Matthews said his initial impression of Canley was that he was under the influence of drugs and a gang member. Matthews said this was based on his appearance and behavior.

Det. Matthews did not believe he said anything to Canley at that time. Matthews turned back to [REDACTED] who shrugged his shoulders as if to say he did not know who Canley was either. Canley then walked west down the sidewalk out of Matthews' view. Det. Matthews began to wrap up his conversation with [REDACTED]. At this point, Canley walked back over and made another comment to the effect, "Fucking Sheriff ain't gonna take me. I'm not - you're not going to take me alive." Det. Matthews then added, "[sic] words to those effect."

Det. Matthews thanked [REDACTED] for his time and turned to walk toward Canley, who was about 15 feet in front of him. Det. Matthews said he was unsure what was going on because he was being confronted by a subject who said he would not be taken alive; and it appeared to Matthews that the Canley had just been chased. Matthews continued saying, "He had that adrenaline rush going, he's high, he's just been chased, like somebody's lookin'

13 DATE / TIME OF REPORT 01/29/07 2:20 PM	14 REPORTING OFFICER / ID NO / DIV / UNIT Detective R. Davidson#2775/Special Services	15 APPROVED BY / ID NO Sgt. W. J. [Signature] 3318
--	--	---

NARRATIVE REPORT VENTURA COUNTY SHERIFF'S DEPARTMENT

Page 2 of 16 Continuation

AGENCY IDENTIFIER CA0560000

1 RD 9072	2 BEAT 9G01	3 RB NUMBER 06-30492
--------------	----------------	-------------------------

4 CODE	5 ITEM	6 QTY	7 ITEM NAME	8 BRAND / MAKE MANUFACTURER	9 MODEL NAME OR NUMBER	10 MISC DESCRIPTION	11 IDENTIFICATION / SERIAL NUMBER	12 VALUE
--------	--------	-------	-------------	-----------------------------	------------------------	---------------------	-----------------------------------	----------

attempting to contact a person named [REDACTED] [REDACTED] in connection with the theft. Matthews believed [REDACTED] lived in apartment 210. Det. Matthews was able to talk with [REDACTED]'s mother [REDACTED] and brother [REDACTED] at the apartment. They told Matthews that [REDACTED] was not home. Matthews left his name and phone number and asked that they have [REDACTED] call him.

As Matthews began to walk toward the parking lot to leave, he passed [REDACTED]. Det. Matthews said he knew what [REDACTED] looked like, as he had viewed a DMV photograph of him as part of his investigation. Matthews called to [REDACTED] and introduced himself to [REDACTED]. Matthews asked [REDACTED] if they could talk, and turned on his digital recorder and began the interview. They stood near a white minivan, which was the first vehicle in the southwest most corner of the parking lot and spoke for about 10 minutes.

After about 10 minutes, Det. Matthews asked [REDACTED] if he wanted to go inside to continue the interview. [REDACTED] declined but suggested they sit on the stairs that lead up to his apartment. [REDACTED] sat on the stairs and Matthews stood next to him while they continued to talk. Det. Matthews said they talked for about 30 minutes. Toward the end of the conversation a male (Canley) appeared behind Matthews. Det. Matthews said he was unsure where Canley came from, but he was about 10 feet away. Canley then said something to the effect, "I know you're the fucking Sheriff and you're not going to take me."

13 DATE / TIME OF REPORT 01/29/07 2:20 PM	14 REPORTING OFFICER / ID NO / DIV / UNIT Detective R. Davidson#2775/Special Services	15 APPROVED BY / ID NO Sgt. W. J. [Signature] 3318
--	--	---

NARRATIVE REPORT VENTURA COUNTY SHERIFF'S DEPARTMENT

Page 4 of 16

Continuation

AGENCY IDENTIFIER CA0560000

1 RD 9072	2 BEAT 9G01	3 RB NUMBER 06-30492
--------------	----------------	-------------------------

4 CODE	5 ITEM	6 QTY	7 ITEM NAME	8 BRAND / MAKE MANUFACTURER	9 MODEL NAME OR NUMBER	10 MISC. DESCRIPTION	11 IDENTIFICATION / SERIAL NUMBER	12 VALUE
--------	--------	-------	-------------	-----------------------------	------------------------	----------------------	-----------------------------------	----------

Supplemental Case Closed

Gang Domestic Hate Child Abuse Elderly Abuse

Connecting Report Numbers:

Code Section / Description: Officer Involved Shooting

Reclassify To:

Code: P Name: Matthews, Shano
 2101 E. Olsen Road
 Thousand Oaks, CA
 (805) 494-8200

WALK THROUGH INTERVIEW - DET. SHANE MATTHEWS

On November 15, 2006 at approximately 0002 hours, I conducted a walk through interview with Detective Shane Matthews concerning a shooting he was involved in earlier in the night. Present during the walk through was my partner Det. Bill Ayub, Bill Hadden, Rick Shimmel, Stacy Ratner, Ryan Kekgran, Lance Steaman, Dave Murray, and Todd Inglis. The walk through took place at the scene of the shooting, [REDACTED]

The crime scene had already being processed and evidence had been collected. The photo markers used in processing the scene were left in place for our benefit and use if needed during the walk through. I began the walk through by asking Det. Matthews to tell us what lead him to be at this particular location. Det. Matthews said he arrived at the apartment complex at a few minutes after 5:00 PM. Matthews told us he was investigating a grand theft from GNC (General Nutrition Center) and was

13 DATE / TIME OF REPORT 01/29/07 2:20 PM	14 REPORTING OFFICER / ID NO / DIV / UNIT Detective R. Davidson#2775/Special Services	15 APPROVED BY / ID NO SGT. W. J. [Signature] 3318
---	--	---

NARRATIVE REPORT VENTURA COUNTY SHERIFF'S DEPARTMENT

Page 1 of 1 Continuation

AGENCY IDENTIFIER CA0560000

1 RD 9072	2 BEAT 9G01	3 RB NUMBER 06-30492
--------------	----------------	-------------------------

4 CODE	5 ITEM	6 QTY.	7 ITEM NAME	8 BRAND / MAKE MANUFACTURER	9 MODEL NAME OR NUMBER	10 MISC. DESCRIPTION	11 IDENTIFICATION / SERIAL NUMBER	12 VALUE
--------	--------	--------	-------------	-----------------------------	------------------------	----------------------	-----------------------------------	----------

- Supplemental Case Cleared
 Gang Domestic Hate Child Abuse Elderly Abuse

Connecting Report Numbers:

Code Section / Description: Officer Involved Shooting

Reclassify To:

Code: P Name: Canley, Adrian d.o.b. 04/01/1981

Transcript of [REDACTED] Interview

On 02/09/07, I reviewed the digital audio recording Detective Sergeant Steve Rhods created when he interviewed [REDACTED], on 11/14/06. Sergeant Rhods provided me with a copy of the recording and a typewritten summary of the interview. I submitted the audio recording to sheriff's clerical staff for transcription, and I received the completed transcript on 02/08/07.

I listened to the entire audio recording and I compared it with the typewritten transcript. After making some minor corrections, I confirmed the typewritten transcript is an accurate representation of the contents of the digital audio recording. Refer to the attached transcript and the digital audio recording for specific details.

13 DATE / TIME OF REPORT 02/09/07/ 11:05 AM	14 REPORTING OFFICER / ID NO / DIV / UNIT Sgt. W. Ayub/#3318/Special Services	15 APPROVED BY / ID NO <i>[Signature]</i> 2175
--	--	---

PROPERTY / EVIDENCE REPORT

VENTURA COUNTY SHERIFF'S DEPARTMENT
AGENCY IDENTIFIER CA0560000

1 CONNECTING REPORT NUMBERS		2 RD 9072	3 BEAT 9601	4 RB NUMBER 06-30492
5 PROPERTY TYPE: <input checked="" type="checkbox"/> EVIDENCE <input type="checkbox"/> FOUND <input type="checkbox"/> SAFEKEEPING		6 <input type="checkbox"/> Misdemeanor <input type="checkbox"/> Felony		7 DATE OF INCIDENT 11/14/2006
8 INCIDENT / OFFENSE(S) (List all probable cause offenses pertaining to this RB.) OFFICER INVOLVED SHOOTING				
CODE: V - Victim S - Suspect A - Arrestee F - Finder O - Owner R - Reporting Party (Use Same Codes in Property Affiliation Boxes.)				
CODE 11	NAME (Last, First, Middle, Gen.) / FIRM NAME P-1 MATTHEWS, SHANE (SENIOR DEPUTY SHERIFF)		AKA / Moniker	RACE 12 W
				SEX 13 M
				14 DOB
				15 BUSINESS PHONE ()
16 RESIDENCE ADDRESS / (<input type="checkbox"/> Same as Box # _____)		CITY	STATE	ZIP
				17 RESIDENCE PHONE ()
CODE 19	NAME (Last, First, Middle, Gen.) / FIRM NAME P-2 CANLEY, ADRIAN (DECEASED)		AKA / Moniker	RACE 20 H
				SEX 21 M
				22 DOB
				23 BUSINESS PHONE ()
24 RESIDENCE ADDRESS / (<input type="checkbox"/> Same as Box # _____)		CITY	STATE	ZIP
				25 RESIDENCE PHONE ()
CODE 27	NAME (Last, First, Middle, Gen.) / FIRM NAME		AKA / Moniker	RACE 28
				SEX 29
				30 DOB
				31 BUSINESS PHONE ()
32 RESIDENCE ADDRESS / (<input type="checkbox"/> Same as Box # _____)		CITY	STATE	ZIP
				33 RESIDENCE PHONE ()
34 NARRATIVE				
35 PROPERTY / EVIDENCE INFORMATION				
LOCATION BOOKED: <input checked="" type="checkbox"/> Ventura <input type="checkbox"/> E.C. <input type="checkbox"/> _____		SEARCH WARRANT ? <input type="checkbox"/> Yes <input checked="" type="checkbox"/> No		FINDER WISHES TO CLAIM? <input type="checkbox"/> Yes <input checked="" type="checkbox"/> No
36 PROPERTY CLASSIFICATION CODES		PROPERTY CODES		
E - EVIDENCE SK - SAFEKEEPING		A - CURRENCY/NOTES D - VEHICLE G - FIREARMS J - LIVESTOCK		
RC - RECOVERED PROPERTY FP - FOUND PROPERTY		B - JEWELRY/PRECIOUS METALS E - OFFICE EQUIPMENT H - HOUSEHOLD GOODS K - MISCELLANEOUS		
		C - CLOTHING/FURS F - ELECTRONIC EQUIPMENT I - CONSUMABLE GOODS		
CODE	ITEM #	QTY	ITEM NAME	MAKE
E/K	1	1	CASSETTE TAPE	
				MODEL / CALIBER
				ID / SERIAL NUMBER
PROP.AFFIL	ADDITIONAL INFORMATION AUDIO RECORDING OF [REDACTED] CALLING SANTA PAULA PD			
CODE	ITEM #	QTY	ITEM NAME	MAKE
E/K	2	1	CASSETTE TAPE	
				MODEL / CALIBER
				ID / SERIAL NUMBER
PROP.AFFIL	ADDITIONAL INFORMATION INTERVIEW OF [REDACTED] BY DET. A. MESA			
CODE	ITEM #	QTY	ITEM NAME	MAKE
E/K	3	1	COMPACT DISC.	
				MODEL / CALIBER
				ID / SERIAL NUMBER
PROP.AFFIL	ADDITIONAL INFORMATION AUDIO RECORDING OF INCIDENT WALK-THRU WITH P.1 MATTHEWS			
37 DATE AND TIME OF REPORT 02/09/07 1400		38 REPORTING OFFICER / ID NO. / DIV / UNIT W. AYUB / 3318 / SPEC. SVC. / M.C.		39 APPROVED BY / ID NO. [Signature] #1917 SEC
40 COPIES TO <input type="checkbox"/> DET / MC <input type="checkbox"/> NARC <input type="checkbox"/> GANG / SEU <input type="checkbox"/> STATS <input type="checkbox"/> PRESS <input type="checkbox"/> DOJ <input type="checkbox"/> COURT <input type="checkbox"/> OTHER				

PROPERTY / EVIDENCE REPORT

VENTURA COUNTY SHERIFF'S DEPARTMENT

AGENCY IDENTIFIER CA0560000

Page 2 of 2

41 RB NUMBER

06-30492

PROPERTY CLASSIFICATION CODES				PROPERTY CODES							
E - EVIDENCE		RC - RECOVERED PROPERTY		A - CURRENCY/NOTES		D - VEHICLE		G - FIREARMS		J - LIVESTOCK	
BK - SAFEKEEPING		FP - FOUND PROPERTY		B - JEWELRY/PRECIOUS METALS		E - OFFICE EQUIPMENT		H - HOUSEHOLD GOODS		K - MISCELLANEOUS	
				C - CLOTHING/FURS		F - ELECTRONIC EQUIPMENT		I - CONSUMABLE GOODS			
CODE	ITEM #	QTY	ITEM NAME	MAKE	MODEL / CALIBER	ID / SERIAL NUMBER					
E	4	6	COMPACT DISCS								
PROP AFFIL	ADDITIONAL INFORMATION AUDIO RECORDINGS OF WITNESS INTERVIEWS CONDUCTED BY SGT. HESS, DET. HARRIS, SGT. RHODS, SR. DEP. MACIAS, DET. HUTTON, AND DEP. BAKER										
CODE	ITEM #	QTY	ITEM NAME	MAKE	MODEL / CALIBER	ID / SERIAL NUMBER					
PROP AFFIL	ADDITIONAL INFORMATION										
CODE	ITEM #	QTY	ITEM NAME	MAKE	MODEL / CALIBER	ID / SERIALNUMBER					
PROP AFFIL	ADDITIONAL INFORMATION										
CODE	ITEM #	QTY	ITEM NAME	MAKE	MODEL / CALIBER	ID / SERIAL NUMBER					
PROP AFFIL	ADDITIONAL INFORMATION										
CODE	ITEM #	QTY	ITEM NAME	MAKE	MODEL / CALIBER	ID / SERIALNUMBER					
PROP AFFIL	ADDITIONAL INFORMATION										
CODE	ITEM #	QTY	ITEM NAME	MAKE	MODEL / CALIBER	ID / SERIALNUMBER					
PROP AFFIL	ADDITIONAL INFORMATION										
CODE	ITEM #	QTY	ITEM NAME	MAKE	MODEL / CALIBER	ID / SERIALNUMBER					
PROP AFFIL	ADDITIONAL INFORMATION										
CODE	ITEM #	QTY	ITEM NAME	MAKE	MODEL / CALIBER	ID / SERIALNUMBER					
PROP AFFIL	ADDITIONAL INFORMATION										
CODE	ITEM #	QTY	ITEM NAME	MAKE	MODEL / CALIBER	ID / SERIALNUMBER					
PROP AFFIL	ADDITIONAL INFORMATION										
CODE	ITEM #	QTY	ITEM NAME	MAKE	MODEL / CALIBER	ID / SERIAL NUMBER					
PROP AFFIL	ADDITIONAL INFORMATION										
CODE	ITEM #	QTY	ITEM NAME	MAKE	MODEL / CALIBER	ID / SERIAL NUMBER					
PROP AFFIL	ADDITIONAL INFORMATION										
CODE	ITEM #	QTY	ITEM NAME	MAKE	MODEL / CALIBER	ID / SERIAL NUMBER					
PROP AFFIL	ADDITIONAL INFORMATION										

CRIME / INCIDENT REPORT

VENTURA COUNTY SHERIFF'S DEPARTMENT
AGENCY IDENTIFIER CA0560000

1 CONNECTING REPORT NUMBERS				2 RD 9072		3 BEAT 9G		4 RB NUMBER 06-30492																			
5 <input type="checkbox"/> CRIME <input type="checkbox"/> INCIDENT <input checked="" type="checkbox"/> SUPPLEMENTAL <input type="checkbox"/> CASE CLOSED <input type="checkbox"/> RECLASSIFICATION					6 <input type="checkbox"/> DOMESTIC <input type="checkbox"/> CHILD ABUSE <input type="checkbox"/> HATE <input type="checkbox"/> GANG <input type="checkbox"/> ELDERLY ABUSE <input type="checkbox"/> ARRC																						
7 CODE SECTION / DESCRIPTION (INCIDENT) OFFICER INVOLVED SHOOTING				8 CLASS <input type="checkbox"/> Misd. <input type="checkbox"/> Fel.		9 CODE SECTION / DESCRIPTION (<input type="checkbox"/> Reclassify To:)				10 CLASS <input type="checkbox"/> Misd. <input type="checkbox"/> Fel.																	
11 CODE SECTION / DESCRIPTION (INCIDENT)				12 CLASS <input type="checkbox"/> Misd. <input type="checkbox"/> Fel.		13 CODE SECTION / DESCRIPTION (<input type="checkbox"/> Reclassify To:)				14 CLASS <input type="checkbox"/> Misd. <input type="checkbox"/> Fel.																	
15 OCCURRED FROM			MO	DAY	YR.	TIME	16 DOW		17 OCCURRED TO			MO	DAY	YR.	TIME	18 DOW											
ADDRESS				CITY THOUSAND OAKS				STATE CA				ZIP 91362															
20 CODE		V - VICTIM		W - WITNESS		R - REPORTING PARTY		F - FINDER		O - OWNER		P - PARTY															
21 CODE	22 NAME (Last, First, Middle, Gen.) / FIRM NAME CANLEY ADRIAN DOYLE			AKA / Moniker		RACE	SEX	25 HT	26 WT	27 HAIR	28 EYES	29 DOB	30 AGE														
31 RESIDENCE ADDRESS / (<input type="checkbox"/> Same as Box # _____)				CITY				STATE				ZIP				32 RESIDENCE PHONE ()											
33 BUSINESS / SCHOOL NAME				ADDRESS / (<input type="checkbox"/> Same as Box # _____)				CITY				STATE				ZIP				34 BUSINESS PHONE ()							
35 OCCUPATION (<input type="checkbox"/> STUDENT)				36 DAYS OFF				37 WORK HRS				38 INTERPRETER				39 OPERATOR'S LIC. NO. / STATE											
40 VEH. LIC. NO. / STATE				41 VEH. COLOR / YEAR / MAKE / MODEL / BODY STYLE				42 OTHER CHARACTERISTICS / VIN NO.																			
43 CODE	44 NAME (Last, First, Middle, Gen.) / FIRM NAME			AKA / Moniker		RACE	SEX	47 HT	48 WT	49 HAIR	50 EYES	51 DOB	52 AGE														
53 RESIDENCE ADDRESS / (<input type="checkbox"/> Same as Box # _____)				CITY				STATE				ZIP				54 RESIDENCE PHONE ()											
55 BUSINESS / SCHOOL NAME				ADDRESS / (<input type="checkbox"/> Same as Box # _____)				CITY				STATE				ZIP				56 BUSINESS PHONE ()							
57 OCCUPATION (<input type="checkbox"/> STUDENT)				58 DAYS OFF				59 WORK HRS				60 INTERPRETER				61 OPERATOR'S LIC. NO. / STATE											
62 VEH. LIC. NO. / STATE				63 VEH. COLOR / YEAR / MAKE / MODEL / BODY STYLE				64 OTHER CHARACTERISTICS / VIN NO.																			
65 ARSON <input type="checkbox"/> Single Family Resd. <input type="checkbox"/> Inhabited <input type="checkbox"/> Uninhabited <input type="checkbox"/> Storage <input type="checkbox"/> Industrial <input type="checkbox"/> Commercial <input type="checkbox"/> Other Structure <input type="checkbox"/> Public Place <input type="checkbox"/> Vehicle <input type="checkbox"/> Unlawful Fire <input type="checkbox"/> Forest <input type="checkbox"/> Injury Occurred <input type="checkbox"/> Other				66 BURGLARY <input type="checkbox"/> Residential <input type="checkbox"/> Vehicle <input type="checkbox"/> Commercial <input type="checkbox"/> Other				67 ROBBERY <input type="checkbox"/> Bank <input type="checkbox"/> Chain Store <input type="checkbox"/> Commercial <input type="checkbox"/> Gas Station <input type="checkbox"/> Highway <input type="checkbox"/> Residence <input type="checkbox"/> Other				68 THEFT <input type="checkbox"/> Auto Parts <input type="checkbox"/> Bicycle <input type="checkbox"/> From Building <input type="checkbox"/> Coin Machine <input type="checkbox"/> From Person <input type="checkbox"/> From Vehicle <input type="checkbox"/> Purse Snatch <input type="checkbox"/> Shoplift <input type="checkbox"/> Other				69 VALUE / DOLLAR LOSS \$ _____ 70 VALUE / DAMAGE LOSS \$ _____				71 FORCE / WEAPON <input type="checkbox"/> No Force <input type="checkbox"/> No Weapon <input type="checkbox"/> Verbal Only <input type="checkbox"/> Attempt Only <input type="checkbox"/> Great Bodily Injury <input type="checkbox"/> Firearm <input type="checkbox"/> Knife <input type="checkbox"/> Hands/Fists/Feet <input type="checkbox"/> Other				72 SPECIAL INTEREST (Copy to Agency/Unit) <input type="checkbox"/> Domestic Violence <input type="checkbox"/> Sex Crime <input type="checkbox"/> Child Abuse <input type="checkbox"/> HSA <input type="checkbox"/> Gang Related <input type="checkbox"/> Hate Crime <input type="checkbox"/> Agricultural <input type="checkbox"/> Probation <input type="checkbox"/> Parole <input type="checkbox"/> Other			
73 DATE AND TIME REPORTED 11-14-06 1820				74 DATE / TIME OF REPORT 11-15-06 / 1600				75 REPORTING OFFICER / ID NO. / DIV / UNIT L. Natoli 3421 ECAS-TO TR11F				76 APPROVED BY / ID NO. [Signature]															
77 COPIES TO												<input type="checkbox"/> DET / MC		<input type="checkbox"/> NARC		<input type="checkbox"/> GANG / SEU		<input type="checkbox"/> STATS		<input type="checkbox"/> PRESS		<input type="checkbox"/> DCJ		<input type="checkbox"/> COURT			

NARRATIVE REPORT VENTURA COUNTY SHERIFF'S DEPARTMENT

Page 3 of 4

Continuation

AGENCY IDENTIFIER CA0560000

1 RD <u>9072</u>	2 BEAT <u>9G</u>	3 RB NUMBER <u>06-30492</u>
---------------------	---------------------	--------------------------------

4 CODE	5 ITEM	6 QTY	7 ITEM NAME	8 BRAND / MAKE MANUFACTURER	9 MODEL NAME OR NUMBER	10 MISC. DESCRIPTION	11 IDENTIFICATION / SERIAL NUMBER	12 VALUE
--------	--------	-------	-------------	-----------------------------	------------------------	----------------------	-----------------------------------	----------

On 11-14-06, at about 1820 hours, I was working traffic enforcement in the city of Thousand Oaks. I heard a call broadcast over the police radio of shots fired at [REDACTED]. I then heard over the radio that 5T3 (Detective Matthews) was involved. I responded code 3 from the area of Conejo School Road and Willow Lane.

I arrived at the location within a minute of hearing 5T3 was involved. As I drove down the driveway of the apartment complex of [REDACTED] I saw two people pointing me in the direction of the incident. Deputy Hall was behind me. At the end of the driveway there was a traffic circle and a parking lot that opened to the left. In the parking lot to the far north, I saw a white truck facing north about to enter the sidewalk around the apartment complex. I saw Senior Deputy Matthews kneeling next to a Hispanic male who was lying on the ground. Matthews was about 2 feet away from the driver's door of the white Ford truck. The driver's door was closed. The Hispanic male's head was facing in a west direction with his feet to the east. Matthews was on the south side of the subject administering first aid.

I stopped my patrol car perpendicular and partially behind the white truck. I got out and Matthew's asked for a first aid kit and gloves. I went to my trunk and threw Matthew's my first aid bag. I put on gloves and went to the subject. Deputies Hall and Berg were around the subject as well. Matthew's stated he was still breathing and had a carotid pulse. Matthew's then stated, "just so you guys know, I fired four rounds, and there is a round right here." I then saw a round next to the subject's right leg. Berg and I cut the sweatshirts and shirts off the subject and exposed his chest. I saw one bullet wound to the right upper chest just below the clavicle.

I observed the subject had his eyes opened and he attempted to talk a few times. He was breathing on his own and Matthews and Berg continued to monitor the carotid pulse. Matthews opened the mask from my first aid kit and began to assist the subject with his breaths. As he began to do that, AMR and the fire department arrived on scene and took over the emergency care.

I then helped Deputy Hall look for shell casings. As we found them, he marked them with folded FI cards. Deputy Berg then asked me to take preliminary photographs of the crime scene. I took digital photographs.

I ran the license plate on the white Ford F-150. It returned to an Adrian D. Canley with an address of [REDACTED]. It was a 1999 Ford F-150. I cleared the subject and he returned with a valid [REDACTED] with the same address and a [REDACTED].

Sergeant Peterson arrived on scene and the crime scene was taped off. Deputy Berg and I alternated guarding the south side of the scene at twenty-minute intervals. At about midnight, Berg was released from the scene and I remained to keep the integrity of the

13 DATE / TIME OF REPORT
11-15-06 / 1600

14 REPORTING OFFICER / ID NO / DIV / UNIT
L. Natoli-3421 ECPS - TO TRAF

15 APPROVED BY / ID NO
T. [Signature] 1203

NARRATIVE REPORT VENTURA COUNTY SHERIFF'S DEPARTMENT

Page 4 of 4

Continuation

AGENCY IDENTIFIER CA0560000

1 RD <u>9072</u>	2 BEAT <u>96</u>	3 RB NUMBER <u>06-30492</u>
---------------------	---------------------	--------------------------------

4 CODE	5 ITEM	6 QTY.	7 ITEM NAME	8 BRAND / MAKE MANUFACTURER	9 MODEL NAME OR NUMBER	10 MISC. DESCRIPTION	11 IDENTIFICATION / SERIAL NUMBER	12 VALUE
--------	--------	--------	-------------	-----------------------------	------------------------	----------------------	-----------------------------------	----------

scene. At about 0100 hours, I completed a CHP 180 tow form for the subject's white Ford F-150. I gave the form to Deputy Tutino and he waited for McCoy's Tow.

At about 0130 hours, I was released from the scene. I sent the digital photographs to the crime lab.

13 DATE / TIME OF REPORT

11-15-06 11600

14 REPORTING OFFICER / ID NO / DIV / UNIT

L. Natali - 3421 - ECRS - TO TRAF

15 APPROVED BY / ID NO

T. [Signature] 1003

CRIME / INCIDENT REPORT

VENTURA COUNTY SHERIFF'S DEPARTMENT

AGENCY IDENTIFIER CA0560000

1 CONNECTING REPORT NUMBERS				2 RD 9072		3 BEAT 96		4 RB NUMBER 06-30492									
5 <input type="checkbox"/> CRIME <input type="checkbox"/> INCIDENT <input checked="" type="checkbox"/> SUPPLEMENTAL <input type="checkbox"/> CASE CLOSED <input type="checkbox"/> RECLASSIFICATION <input type="checkbox"/>					6 <input type="checkbox"/> DOMESTIC <input type="checkbox"/> CHILD ABUSE <input type="checkbox"/> HATE <input type="checkbox"/> GANG <input type="checkbox"/> ELDERLY ABUSE <input type="checkbox"/> ARRC												
7 CODE SECTION / DESCRIPTION (INCIDENT) OFFICER INVOLVED SHOOTING				8 CLASS. <input type="checkbox"/> Misd. <input type="checkbox"/> Fel.		9 CODE SECTION / DESCRIPTION (<input type="checkbox"/> Reclassify To:)				10 CLASS. <input type="checkbox"/> Misd. <input type="checkbox"/> Fel.							
11 CODE SECTION / DESCRIPTION (INCIDENT)				12 CLASS. <input type="checkbox"/> Misd. <input type="checkbox"/> Fel.		13 CODE SECTION / DESCRIPTION (<input type="checkbox"/> Reclassify To:)				14 CLASS. <input type="checkbox"/> Misd. <input type="checkbox"/> Fel.							
15 OCCURRED FROM			MO. DAY YR. TIME		16 DOW		17 OCCURRED TO			MO. DAY YR. TIME							
11			14 06		-		11			14 06							
19 LOCATION OF OFFENSE / INCIDENT				ADDRESS				CITY				STATE		ZIP			
20 CODE:		V - VICTIM		W - WITNESS		R - REPORTING PARTY		F - FINDER		O - OWNER		P - PARTY					
21 CODE		22 NAME (Last, First, Middle, Gen.) / FIRM NAME				AKA / Moniker		23 RACE	24 SEX	25 HT	26 WT	27 HAIR	28 EYES	29 DOB	30 AGE		
		CANLEY, ADRIAN															
31 RESIDENCE ADDRESS / (<input type="checkbox"/> Same as Box # _____)								CITY		STATE		ZIP		32 RESIDENCE PHONE			
33 BUSINESS / SCHOOL NAME								ADDRESS / (<input type="checkbox"/> Same as Box # _____)		CITY		STATE		ZIP		34 BUSINESS PHONE	
35 OCCUPATION (<input type="checkbox"/> STUDENT)				36 DAYS OFF		37 WORK HRS		38 INTERPRETER		39 OPERATOR'S LIC. NO. / STATE							
40 VEH. LIC. NO. / STATE		41 VEH. COLOR / YEAR / MAKE / MODEL / BODY STYLE		42 OTHER CHARACTERISTICS / VIN NO.													
43 CODE		44 NAME (Last, First, Middle, Gen.) / FIRM NAME				AKA / Moniker		45 RACE	46 SEX	47 HT	48 WT	49 HAIR	50 EYES	51 DOB	52 AGE		
53 RESIDENCE ADDRESS / (<input type="checkbox"/> Same as Box # _____)								CITY		STATE		ZIP		54 RESIDENCE PHONE			
55 BUSINESS / SCHOOL NAME								ADDRESS / (<input type="checkbox"/> Same as Box # _____)		CITY		STATE		ZIP		56 BUSINESS PHONE	
57 OCCUPATION (<input type="checkbox"/> STUDENT)				58 DAYS OFF		59 WORK HRS		60 INTERPRETER		61 OPERATOR'S LIC. NO. / STATE							
62 VEH. LIC. NO. / STATE		63 VEH. COLOR / YEAR / MAKE / MODEL / BODY STYLE		64 OTHER CHARACTERISTICS / VIN NO.													
65 ARSON		66 BURGLARY		68 THEFT		70 FORCE / WEAPON		72 SPECIAL INTEREST									
<input type="checkbox"/> Single Family Resd. <input type="checkbox"/> Inhabited <input type="checkbox"/> Uninhabited <input type="checkbox"/> Storage <input type="checkbox"/> Industrial <input type="checkbox"/> Commercial <input type="checkbox"/> Other Structure <input type="checkbox"/> Public Place <input type="checkbox"/> Vehicle <input type="checkbox"/> Unlawful Fire <input type="checkbox"/> Forest <input type="checkbox"/> Injury Occurred <input type="checkbox"/> Other		<input type="checkbox"/> Residential <input type="checkbox"/> Vehicle <input type="checkbox"/> Commercial <input type="checkbox"/> Other		<input type="checkbox"/> Auto Parts <input type="checkbox"/> Bicycle <input type="checkbox"/> From Building <input type="checkbox"/> Coin Machine <input type="checkbox"/> From Person <input type="checkbox"/> From Vehicle <input type="checkbox"/> Purse Snatch <input type="checkbox"/> Shoplift <input type="checkbox"/> Other		<input type="checkbox"/> No Force <input type="checkbox"/> No Weapon <input type="checkbox"/> Verbal Only <input type="checkbox"/> Attempt Only <input type="checkbox"/> Great Bodily Injury <input type="checkbox"/> Firearm <input type="checkbox"/> Knife <input type="checkbox"/> Hands/Fists/Feet <input type="checkbox"/> Other		<input type="checkbox"/> Domestic Violence <input type="checkbox"/> Sex Crime <input type="checkbox"/> Child Abuse <input type="checkbox"/> HSA <input type="checkbox"/> Gang Related <input type="checkbox"/> Hate Crime <input type="checkbox"/> Agricultural <input type="checkbox"/> Probation <input type="checkbox"/> Parole <input type="checkbox"/> Other									
67 ROBBERY		69 VALUE / DOLLAR LOSS		71 DOMESTIC VIOLENCE / STALKING / SEX / HATE CRIMES													
<input type="checkbox"/> Bank <input type="checkbox"/> Chain Store <input type="checkbox"/> Commercial <input type="checkbox"/> Gas Station <input type="checkbox"/> Highway <input type="checkbox"/> Residence <input type="checkbox"/> Other		\$ _____ VALUE / DAMAGE LOSS \$ _____		<input type="checkbox"/> Per 264.2 PC, "Victims of Domestic Violence" pamphlet given to: <input type="checkbox"/> VICTIM (Includes sexual assault victims) <input type="checkbox"/> P-1 <input type="checkbox"/> P-2 <input type="checkbox"/> Per 6254 GC, Victim of DV, Stalking, Sex or Hate Crime requests his/her name be withheld from the public. <input type="checkbox"/> YES <input type="checkbox"/> NO													
73 DATE AND TIME REPORTED		74 DATE / TIME OF REPORT		75 REPORTING OFFICER / ID NO. / DIV. / UNIT				76 APPROVED BY / ID NO.									
11-14-06 / 1420		11-15-06 / 1707		HALL 3472 / ECPs - TRAFFIC				T. [Signature]									
77 COPIES TO <input type="checkbox"/> DET / MC <input type="checkbox"/> NARC <input type="checkbox"/> GANG / SEU <input type="checkbox"/> STATS <input type="checkbox"/> PRESS <input type="checkbox"/> DOJ <input type="checkbox"/> COURT _____																	

NARRATIVE REPORT VENTURA COUNTY SHERIFF'S DEPARTMENT

Page 3 of 3

Continuation

AGENCY IDENTIFIER CA0560000

1 RD 9072	2 BEAT 96	3 R3 NUMBER 06-30492
--------------	--------------	-------------------------

4 CODE	5 ITEM	6 QTY.	7 ITEM NAME	8 BRAND / MAKE MANUFACTURER	9 MODEL NAME OR NUMBER	10 MISC. DESCRIPTION	11 IDENTIFICATION / SERIAL NUMBER	12 VALUE
--------	--------	--------	-------------	-----------------------------	------------------------	----------------------	-----------------------------------	----------

On 11-14-06, at approximately 1820 hours, I was working traffic enforcement on a marked black and white police motorcycle in the city of Thousand Oaks. I heard a call over the radio of a report of shots fired at [REDACTED]. The call was then updated over the radio that Senior Deputy Matthews was involved.

I responded code three (lights and siren) to the location following Deputy Natoli. When we arrived at the apartment complex, we drove south through the driveway. I saw bystanders pointing south farther into the complex.

There was a parking lot to the east side of the driveway as we reached the south end of it. I saw a white truck stopped on a curb facing northbound. There was a Hispanic male lying face up on the ground just outside the driver's side of the truck. Senior Deputy Matthews was kneeling on the south side of the man. Natoli stopped her police car, and I stopped behind her.

Matthews asked for a first aid kit. Someone provided one to him. He and Natoli began first aid. Deputy Berg also arrived on scene. The man's clothes were cut off of him. I saw a gunshot wound in the man's front right upper chest. The man had his eyes open and his breathing seemed labored. Matthew's gave the man several rescue breathes with a CPR mask. AMR and the Ventura County Fire Department arrived on scene and took over medical treatment of the man.

While Matthews had been providing first aid, he said he fired his weapon four times. I asked if there were any outstanding suspects. Matthews said there was not.

Matthews walked with me to show the extent of the scene so I could secure the scene with crime scene tape. While showing the area to me, Matthews spontaneously stated that the man had told Matthew's that he (the man) would not be taken alive.

Other units and supervisors arrived on scene. I checked the scene for evidence. I found four shell casings to the southwest of where the truck had stopped. I also found the copper jacket of a round to the east of where I found the casing. I marked the items I found with folded FI cards.

I was released from the scene at approximately 1900 hours to respond to a traffic accident.

13 DATE / TIME OF REPORT 11-14-06/1820	14 REPORTING OFFICER / ID NO. / DIV / UNIT Hall 3472/ELPS/TRAFFIC	15 APPROVED BY / ID NO. T. [Signature] 100
---	--	---

CRIME / INCIDENT REPORT

VENTURA COUNTY SHERIFF'S DEPARTMENT
AGENCY IDENTIFIER CA0560000

Form with multiple sections: 1 CONNECTING REPORT NUMBERS, 2 R.D., 3 BEAT, 4 RB NUMBER, 5 CRIME/INCIDENT/SUPPLEMENTAL, 6 DOMESTIC/CHILD ABUSE/HATE, 7 CODE SECTION/DESCRIPTION, 8 CLASS, 9 CODE SECTION/DESCRIPTION, 10 CLASS, 11 CODE SECTION/DESCRIPTION, 12 CLASS, 13 CODE SECTION/DESCRIPTION, 14 CLASS, 15 OCCURRED FROM, 16 DOW, 17 OCCURRED TO, 18 DOW, 19 LOCATION OF OFFENSE, 20 CODE, 21 NAME, 22 NAME, 23 RACE, 24 SEX, 25 HT, 26 WT, 27 HAIR, 28 EYES, 29 DOB, 30 AGE, 31 RESIDENCE ADDRESS, 32 RESIDENCE PHONE, 33 BUSINESS/SCHOOL NAME, 34 BUSINESS PHONE, 35 OCCUPATION, 36 DAYS OFF, 37 WORK HRS, 38 INTERPRETER, 39 OPERATOR'S LIC. NO., 40 VEH. LIC. NO., 41 VEH. COLOR, 42 OTHER CHARACTERISTICS, 43 NAME, 44 NAME, 45 RACE, 46 SEX, 47 HT, 48 WT, 49 HAIR, 50 EYES, 51 DOB, 52 AGE, 53 RESIDENCE ADDRESS, 54 RESIDENCE PHONE, 55 BUSINESS/SCHOOL NAME, 56 BUSINESS PHONE, 57 OCCUPATION, 58 DAYS OFF, 59 WORK HRS, 60 INTERPRETER, 61 OPERATOR'S LIC. NO., 62 VEH. LIC. NO., 63 VEH. COLOR, 64 OTHER CHARACTERISTICS, 65 ARSON, 66 BURGLARY, 67 ROBBERY, 68 THEFT, 69 VALUE/DOLLAR LOSS, 70 FORCE/WEAPON, 71 DOMESTIC VIOLENCE, 72 SPECIAL INTEREST, 73 DATE AND TIME REPORTED, 74 DATE/TIME OF REPORT, 75 REPORTING OFFICER, 76 APPROVED BY, 77 COPIES TO, 78 OTHER.

NARRATIVE REPORT VENTURA COUNTY SHERIFF'S DEPARTMENT

Page 3 of 4 Continuation

AGENCY IDENTIFIER CA0560000

1 RD <u>9072</u>	2 BEAT <u>9601</u>	3 RB NUMBER <u>06-30492</u>
---------------------	-----------------------	--------------------------------

4 CODE	5 ITEM	6 QTY	7 ITEM NAME	8 BRAND / MAKE MANUFACTURER	9 MODEL NAME OR NUMBER	10 MISC. DESCRIPTION	11 IDENTIFICATION / SERIAL NUMBER	12 VALUE
--------	--------	-------	-------------	-----------------------------	------------------------	----------------------	-----------------------------------	----------

On 11/14/2006, I was working patrol in the City of Thousand Oaks driving a marked black & white patrol car and in full uniform.

At approximately 1841 hours, I was dispatched to a call of shots heard in the area of [REDACTED] Initial information was that 5 – 6 shots were heard in front of that apartment. As I responded to the address, I heard Deputy Ferruzza broadcast over the radio that Detective Matthews was involved in the shooting. Myself, along with several other Deputies responded Code-3 to the scene.

When I arrived, Deputies Natoli and Hall were already on scene. Both Natoli and Hall, along with Detective Matthews, were leaning over and rendering first aid to a male subject that was lying on the ground adjacent to a white Ford F150 pick-up. After retrieving my first aid kit, I also went to assist in rendering first aid.

The male subject was lying on his back and unconscious, and appeared to have trouble breathing. I could also see blood on the front his shirt. Deputy Natoli said that she was unable to feel a pulse on the subject's wrist. I was able to feel a weak pulse at the subject's carotid artery. Using trauma shears, I began to cut away the subjects shirt and jacket, exposing his chest area. Once the subject's upper torso was uncovered I could clearly see one bullet entrance wound above the subject's right breast / pectoral area, which was slightly bleeding. I was unable to see any other obvious injuries on the front of the subject's torso. Because of his labored breathing, Detective Matthews used a manual ventilating mask to assist the subject with getting air into his lungs.

Senior Deputy Grambling arrived during this time, and advised Sheriff's dispatch to have EMS personnel come into the scene once they arrived. Once Ventura County Fire Department Paramedics arrived on scene and took medical control of the scene, I asked Grambling to escort Detective Matthews away from the immediate

13 DATE / TIME OF REPORT <u>11-15-2006 / 0030</u>	14 REPORTING OFFICER / ID NO / DIV / UNIT <u>BERG #1929 / EPS - THOAKS</u>	15 APPROVED BY / ID NO <u>[Signature] / 2416</u>
--	---	---

NARRATIVE REPORT VENTURA COUNTY SHERIFF'S DEPARTMENT

Page 4 of 4 Continuation

AGENCY IDENTIFIER CA0560000

1. RD <i>9072</i>	2. BEAT <i>9601</i>	3. RD NUMBER <i>06-30492</i>
----------------------	------------------------	---------------------------------

4. CODE	5. ITEM	6. QTY.	7. ITEM NAME	8. BRAND / MAKE MANUFACTURER	9. MODEL NAME OR NUMBER	10. MISC. DESCRIPTION	11. IDENTIFICATION / SERIAL NUMBER	12. VALUE
---------	---------	---------	--------------	------------------------------	-------------------------	-----------------------	------------------------------------	-----------

scene. Because of his involvement in the shooting, I believed it would be less mental stress on Detective Matthews if he didn't watch as paramedics examine and provide medical care to the subject.

Fire Paramedics [redacted] and [redacted] continued to provide medical care to the male subject, who remained unconscious with labored breathing. I was asked to completely cut-off the subject's upper clothing, which I did with my trauma shears. Ventura County Fire Engine Captain [redacted], along with Engineer [redacted] and Fire Fighter [redacted] arrived a short time later and assisted with administering aid to the subject. At one point, as Paramedic [redacted] was cutting-off the subject's pants he yelled "there's a gun here!" I immediately went to [redacted]'s side and could see a black semi-automatic handgun lying next to the subject's right leg. The handgun apparently was inside the subject's pant leg, and was exposed after the pant leg was cut open. Because the paramedics were preparing to move the subject onto a backboard in order to transport him to the hospital, the weapon was left where it was discovered. I alerted all medical personnel of the presence of the weapon, then instructed them to leave the gun and all other items untouched (other than their medical equipment) at the scene.

As other Sheriff personnel arrived on scene, an inner perimeter as well as an extended perimeter was established. Sgt Peterson arrived and began assigning tasks - I continued my visual control of the handgun, subject's clothing and other items located where medical aid was initially given until I was relieved of my position.

13. DATE / TIME OF REPORT <i>11-15-2006 / 0030</i>	14. REPORTING OFFICER / ID NO. / DIV / UNIT <i>BERG #1929 / ECPS-TOAMS</i>	15. APPROVED BY / ID NO. <i>[Signature] / 7186</i>
---	---	---

NARRATIVE REPORT VENTURA COUNTY SHERIFF'S DEPARTMENT

Page 1 of 1 Continuation

AGENCY IDENTIFIER CA0560000

9072

9G

06-30492

4 CODE	5 ITEM	6 QTY	7 ITEM NAME	8 BRAND / MAKE MANUFACTURER	9 MODEL NAME OR NUMBER	10 MISC. DESCRIPTION	11 IDENTIFICATION / SERIAL NUMBER	12 VALUE
--------	--------	-------	-------------	-----------------------------	------------------------	----------------------	-----------------------------------	----------

- Supplemental
 Case Closed
 Reclassification
 Domestic
 Child Abuse
 Hate
 Gang
 Elderly Abuse
 ARRC

Connecting Report Numbers:

Code Section / Description: 245(a)(1) PC

Code Section / Description (Reclassify To:)

Code: S **Name:** Canley, Adrian Doyle

On 11-14-06, at about 1824 hours, I responded to a deputy involved shooting at [REDACTED] in Thousand Oaks. I arrived and parked my vehicle next to Los Feliz Drive and then I walked to the scene.

While at the scene, I contacted Detective Matthews and I asked him if there was anyone I needed to contact. Matthews told me that after the incident a subject (possible witness) came up to him and he directed that subject to wait by the sidewalk on the west side of the parking lot. Matthews described the subject to me as a Hispanic male with long hair, wearing shorts and no shirt. I did a quick search of the area with negative results.

I then conducted a search of the vehicles in the parking lot to make sure the scene was clear of additional subjects / suspects. The following license plates are from vehicles in the parking lot: (counter clockwise from the northwest corner of the lot)



I then added additional crime scene tape and I secured the scene.

13 DATE / TIME OF REPORT 11/15/2006 8:48 AM	14 REPORTING OFFICER / ID NO. / DIV / UNIT G. AXELROD #3114 / ECPS / SEU	15 APPROVED BY / ID NO. <i>[Signature]</i> 1354
--	---	--

CRIME / INCIDENT REPORT

VENTURA COUNTY SHERIFF'S DEPARTMENT
AGENCY IDENTIFIER CA0560000

1 CONNECTING REPORT NUMBERS
2 RD 9072
3 BEAT 96
4 RB NUMBER 06-30492

5 CRIME INCIDENT SUPPLEMENTAL
6 DOMESTIC CHILD ABUSE HATE
GANG ELDERLY ABUSE ARRC

7 CODE SECTION / DESCRIPTION (INCIDENT)
245(C) PC / ADW ON POLICE OFFICER
8 CLASS. Fel.
9 CODE SECTION / DESCRIPTION (Reclassify To:)

11 CODE SECTION / DESCRIPTION (INCIDENT)
12 CLASS.
13 CODE SECTION / DESCRIPTION (Reclassify To:)

15 OCCURRED FROM MO. DAY YR. TIME
16 DOW
17 OCCURRED TO MO. DAY YR. TIME
18 DOW

19 LOCATION OF OFFENSE / INCIDENT ADDRESS CITY STATE ZIP

20 CODE: V - VICTIM W - WITNESS R - REPORTING PARTY F - FINDER O - OWNER P - PARTY

21 CODE 22 NAME (Last, First, Middle, Gen.) / FIRM NAME
MATTHEWS, SHANE
23 RACE 24 SEX 25 HT 26 WT 27 HAIR 28 EYES 29 DOB 30 AGE

31 RESIDENCE ADDRESS / (Same as Box #) CITY STATE ZIP
32 RESIDENCE PHONE

33 BUSINESS / SCHOOL NAME ADDRESS / (Same as Box #) CITY STATE ZIP
34 BUSINESS PHONE

35 OCCUPATION (STUDENT) 36 DAYS OFF 37 WORK HRS 38 INTERPRETER 39 OPERATOR'S LIC. NO. / STATE

40 VEH. LIC. NO. / STATE 41 VEH. COLOR / YEAR / MAKE / MODEL / BODY STYLE 42 OTHER CHARACTERISTICS / VIN NO.

43 CODE 44 NAME (Last, First, Middle, Gen.) / FIRM NAME
45 RACE 46 SEX 47 HT 48 WT 49 HAIR 50 EYES 51 DOB 52 AGE

53 RESIDENCE ADDRESS / (Same as Box #) CITY STATE ZIP
54 RESIDENCE PHONE

55 BUSINESS / SCHOOL NAME ADDRESS / (Same as Box #) CITY STATE ZIP
56 BUSINESS PHONE

57 OCCUPATION (STUDENT) 58 DAYS OFF 59 WORK HRS 60 INTERPRETER 61 OPERATOR'S LIC. NO. / STATE

62 VEH. LIC. NO. / STATE 63 VEH. COLOR / YEAR / MAKE / MODEL / BODY STYLE 64 OTHER CHARACTERISTICS / VIN NO.

65 ARSON 66 BURGLARY 67 ROBBERY 68 THEFT 69 VALUE / DOLLAR LOSS 70 FORCE / WEAPON 71 DOMESTIC VIOLENCE / STALKING / SEX / HATE CRIMES 72 SPECIAL INTEREST

73 DATE AND TIME REPORTED 74 DATE / TIME OF REPORT 75 REPORTING OFFICER / ID NO. / DIV. / UNIT 76 APPROVED BY / ID NO.

77 COPIES TO DET / MC NARC GANG / SEU STATS PRESS DOJ COURT

NARRATIVE REPORT VENTURA COUNTY SHERIFF'S DEPARTMENT

Page 3 of 3 Continuation

AGENCY IDENTIFIER CA0560000

1 RD 9072	2 BEAT 96	3 RB NUMBER 06-30492
--------------	--------------	-------------------------

4 CODE	5 ITEM	6 QTY	7 ITEM NAME	8 BRAND / MAKE MANUFACTURER	9 MODEL NAME OR NUMBER	10 MISC. DESCRIPTION	11 IDENTIFICATION / SERIAL NUMBER	12 VALUE
--------	--------	-------	-------------	-----------------------------	------------------------	----------------------	-----------------------------------	----------

On the evening of 11-14-2006 I was working uniformed patrol in the city of Thousand Oaks. Deputy Berg and I were dispatched to a call of shots fired at [REDACTED] at 1820 hours. Shortly after the initial call we were advised to respond code 3. While we were enroute to the call it was advised on the radio that the shots fired call involved Sr Deputy Matthews.

While I was still enroute to the call I heard Deputy Natoli (9T3) and Deputy Hall (9M6) report that they were on scene. A short time later Deputy Berg reported that he was on scene. I arrived shortly after Deputy Berg. I drove up the driveway of [REDACTED] and parked near the turn-around. I saw a white pick-up truck stopped at an angle in the N/E corner of the rear parking lot. Deputy Berg and Sr Deputy Matthews were administering first aid to a male subject laying on the asphalt near the truck.

Sr Deputy Matthews was questioned quickly, and it was determined that there were no outstanding suspects. Dispatch was advised to have emergency medical personnel respond the scene. Paramedics arrived very shortly thereafter, and Sr Deputy Matthews was removed from the first aid efforts. Sr Deputy Matthews pointed towards a male subject standing close by and told me that he had been interviewing him when the incident occurred on an unrelated crime, and that he was a witness.

Sr Deputy Matthews described the boundaries of the crime scene, and crime scene tape was placed around area. The witness was detained, and when Sr Deputy Buschow (detective) arrived on scene, he was directed towards the witness. Sgt Peterson arrived during this, and he set up a command post on the west side of the parking lot.

When I heard that the fire department's light and air truck was enroute, I advised Sgt Peterson that I was going to back my patrol car out of the immediate area to make room for the fire truck. I then backed my patrol car out behind the outer perimeter and parked it behind another patrol car. I then assumed a post at the tape marking the outer perimeter to control access. I remained at this post until I was relieved by Deputy Jones at approximately 0030 hours.

13 DATE / TIME OF REPORT 11/17/06/2007	14 REPORTING OFFICER / ID NO / DIV / UNIT GRANBLINK/2651/5007	15 APPROVED BY / ID NO <i>[Signature]</i> / 2486
---	--	---

NARRATIVE REPORT VENTURA COUNTY SHERIFF'S DEPARTMENT

Page 1 of 2 Continuation

AGENCY IDENTIFIER CA0560000

1 RID 9072	2 BEAT 9G01	3 RB NUMBER 06-30492
---------------	----------------	-------------------------

4 CODE	5 ITEM	6 QTY.	7 ITEM NAME	8 BRAND / MAKE MANUFACTURER	9 MODEL NAME OR NUMBER	10 MISC. DESCRIPTION	11 IDENTIFICATION / SERIAL NUMBER	12 VALUE
--------	--------	--------	-------------	-----------------------------	------------------------	----------------------	-----------------------------------	----------

- Supplemental** **Case Cleared**
 Gang **Domestic** **Hate** **Child Abuse** **Elderly Abuse**

Connecting Report Numbers:

Code Section / Description: Officer-Involved Shooting

Reclassify To:

Code: S **Name:** Canley, Adrian

On 11/14/06 at approximately 1820 hours, I was working uniformed patrol in the City of Thousand Oaks as a Patrol Sergeant. While conducting Shift II briefing at Station 10, I heard Dispatch broadcast a call of "shots fired, man down" at [REDACTED] I immediately left the station and responded to the scene.

Upon arriving at the scene, I saw that patrol units had begun setting up a perimeter with crime scene tape. I entered the crime scene and saw paramedics administering first aid to a male adult subject [later identified as (S) Adrian Canley], who appeared to be suffering from a gunshot wound to the upper left side of his chest. I also saw what appeared to be a .45 caliber semi-automatic handgun lying on the ground near Canley's feet. I directed a patrol deputy to standby with the weapon until it could be made safe and collected as evidence.

Soon thereafter, I was made aware that the shooting was officer-involved and that Senior Deputy S. Matthews had fired the shots that wounded (S) Canley. Sgt. M. Powers of Major Crimes and I made sure that Senior Deputy Matthews was not injured and was appropriately sequestered from other personnel.

Sergeant J. Weaver of ECPS Investigations also arrived on-scene, so I assigned him as head of Operations and asked him to coordinate the canvassing of the area for possible witnesses.

13 DATE / TIME OF REPORT 11-19-06 / 2300	14 REPORTING OFFICER / ID NO. / DIV / UNIT C. PETERSON/2784/ECPS PATROL <i>CP</i>	15 APPROVED BY / ID NO. <i>A. [Signature]</i> / 2486
---	--	---

NARRATIVE REPORT VENTURA COUNTY SHERIFF'S DEPARTMENT

Page 2 of 2 Continuation

AGENCY IDENTIFIER CA0560000

1 RD 9072	2 BEAT 9G0	3 RB NUMBER 06-30492
---------------------	----------------------	--------------------------------

4 CODE	5 ITEM	6 QTY.	7 ITEM NAME	8 BRAND / MAKE MANUFACTURER	9 MODEL NAME OR NUMBER	10 MISC. DESCRIPTION	11 IDENTIFICATION / SERIAL NUMBER	12 VALUE
--------	--------	--------	-------------	-----------------------------	------------------------	----------------------	-----------------------------------	----------

I then established an incident command post at my patrol unit and took up the tasks involved in securing the crime scene. I assigned Senior Deputy E. Hatlee as Scribe, responsible for checking personnel in at the scene, and Deputy A. Tutino as an assistant scribe responsible for tracking which of those personnel entered the inner perimeter of the scene.

I stayed at the scene as Incident Commander for the remainder of the incident, until all witnesses had been interviewed, evidence had been collected, and (S) Canley's vehicle had been impounded as evidence. At approximately 0159 hours, I shut down the command post and cleared the scene.

13 DATE / TIME OF REPORT 11-19-06 / 2300	14 REPORTING OFFICER / ID NO / DIV / UNIT C. PETERSON/2784/ECPS PATROL	15 APPROVED BY / ID NO <i>[Signature]</i> / 2986
--	--	--

NARRATIVE REPORT VENTURA COUNTY SHERIFF'S DEPARTMENT

Page 1 of 1 Continuation

AGENCY IDENTIFIER CA0560000

1 RD 9072	2 BEAT 9G01	3 RB NUMBER 06-30492
--------------	----------------	-------------------------

4 CODE	5 ITEM	6 QTY.	7 ITEM NAME	8 BRAND / MAKE MANUFACTURER	9 MODEL NAME OR NUMBER	10 MISC. DESCRIPTION	11 IDENTIFICATION / SERIAL NUMBER	12 VALUE
--------	--------	--------	-------------	-----------------------------	------------------------	----------------------	-----------------------------------	----------

- Supplemental Case Cleared
 Gang Domestic Hate Child Abuse Elderly Abuse

Connecting Report Numbers:

Code Section / Description: 245PC /ADW on Peace Officer

Reclassify To:

Code: V Name: Shane Matthews

On 11-14-2006 at approximately 1820 hours, I responded to an officer involved shots fired call at [REDACTED] in Thousand Oaks. Upon my arrival the interior crime scene had been taped off and I saw fire and ambulance personnel working on the suspect in the parking lot near the recreation building for the complex. Deputies Berg, Natoli, Hall, Harris, and Axelrod were in the crime scene marking and looking for evidence.

Detective Matthews was outside the interior crime scene. I located Matthews to check on his well-being. I also spoke to him to determine if anyone else was involved. Matthews told me the person fire and ambulance personnel was the only suspect involved. He said the person he was there to interview was a witness and another person wearing white may have seen what happened but that person ran off and his whereabouts were unknown.

Detective Buschow arrived and interviewed the witness Matthews was interviewing when the incident occurred. Deputy Ferruzza stayed with Matthews. Sgt. Peterson arrived and directed me to scribe for the incident.

I then started to scribe the personnel in the crime scene and maintained a position at the command post with Sgt. Peterson until relieved by Sr. Deputy Morris at approximately 2400 hours.

13 DATE / TIME OF REPORT 11-23-06 / 1945	14 REPORTING OFFICER / ID NO. / DIV / UNIT HATLEE/2507/EAST COUNTY/PATROL	15 APPROVER / ID NO. <i>[Signature]</i>
---	--	--

NARRATIVE REPORT VENTURA COUNTY SHERIFF'S DEPARTMENT

Page 1 of 2 Continuation

AGENCY IDENTIFIER CA0560000

1 RD 9072	2 BEAT 9G01	3 RB NUMBER 2006-30492
--------------	----------------	---------------------------

4 CODE	5 ITEM	6 QTY	7 ITEM NAME	8 BRAND / MAKE MANUFACTURER	9 MODEL NAME OR NUMBER	10 MISC. DESCRIPTION	11 IDENTIFICATION / SERIAL NUMBER	12 VALUE
--------	--------	-------	-------------	-----------------------------	------------------------	----------------------	-----------------------------------	----------

- Supplemental Case Cleared
 Gang Domestic Hate Child Abuse Elderly Abuse

Connecting Report Numbers:

Code Section / Description: 245(c) P.C.

Reclassify to:

Code: S-1 Name: Canley, Adrian

Notification and Response

On 11/14/06, at approximately 1830 hours, I received a call from Detective Harris. Harris informed me that he just heard via the dispatch radio that a shooting had occurred in Thousand Oaks on Los Feliz Drive. He further informed me that Detective Matthews may be involved, and that he was responding to the above location. I told Harris that I would advise Detective Miller, who was also at the Thousand Oaks Police / Sheriff Station with me.

I immediately notified Det. Miller of the above incident. Miller accessed the incident from our Computer Aided Dispatch (C.A.D.) system and printed copies of the call slip. We also notified Sergeant Weaver of the incident, who was still in the station. Sgt. Weaver, Det. Miller, and I responded to the scene.

I arrived at the above location at approximately 1840 hours. I saw several patrol units, an AMR ambulance, and a Ventura County Fire Engine from station # 31 already on scene. I saw fire and paramedic personnel loading a male adult subject into the ambulance, and then drive away from the scene.

I then located Detective Matthews and Deputy Ferruzza in the circular portion of the driveway just east of the Fire Engine. I approached both Det. Matthews and Dep. Ferruzza and asked what happened. Det. Matthews said he was involved in a shooting. I asked him if he was injured, and he said he was not injured. Det. Matthews also informed me that he recorded the

13 DATE / TIME OF REPORT 11-16-06 / 0937	14 REPORTING OFFICER / ID NO / DIV / UNIT Det. J. Smith/#2569/East County M.C.	15 APPROVED BY / ID NO <i>J. Smith #2569</i>
---	---	---

NARRATIVE REPORT VENTURA COUNTY SHERIFF'S DEPARTMENT

Page 2 of 2 Continuation

AGENCY IDENTIFIER CA0560000

1 RD 9072	2 BEAT 9G01	3 RB NUMBER 2006-30492
--------------	----------------	---------------------------

4 CODE	5 ITEM	6 QTY.	7 ITEM NAME	8 BRAND / MAKE MANUFACTURER	9 MODEL NAME OR NUMBER	10 MISC. DESCRIPTION	11 IDENTIFICATION / SERIAL NUMBER	12 VALUE
--------	--------	--------	-------------	-----------------------------	------------------------	----------------------	-----------------------------------	----------

incident on his digital recorder, and gave his digital recorder to Dep. Ferruzza. I asked Dep. Ferruzza to give me Det. Matthews' digital recorder, since it is now evidence. Dep. Ferruzza took the recorder from his right shirt pocket and handed it to me. I noticed the recorder was turned off before I secured it into my briefcase.

I then directed Det. Matthews to sit in Det. Harris' vehicle, which was parked nearby. I instructed Det. Harris to open his vehicle for Det. Matthews, but to remain outside of his vehicle. I further instructed Det. Harris to remain nearby to watch Det. Matthews, and he complied.

I then instructed Deputy Hawthorne to follow the ambulance to Los Robles Hospital and to remain with the male suspect from this incident. Dep. Hawthorne immediately complied and left the scene.

I then walked to my vehicle and secured my briefcase with Det. Matthews' recorder in the locked trunk of my vehicle.

Soon, Sergeant Powers arrived on the scene. After a few minutes, Sgt. Powers told me to interview the firefighters that were still on scene. Refer to my other interviews for further details.

13 DATE / TIME OF REPORT 11-16-06 / 0937	14 REPORTING OFFICER / ID NO / DIV / UNIT Det. J. Smith/#2569/East County M.C.	15 APPROVED BY / ID NO <i>[Signature]</i> / 2486
---	---	---

NARRATIVE REPORT VENTURA COUNTY SHERIFF'S DEPARTMENT

Page 1 of 1 Continuation

AGENCY IDENTIFIER CA0560000

1 RD 9072	2 BEAT 9G01	3 RB NUMBER 060030492
--------------	----------------	--------------------------

4 CODE	5 ITEM	6 QTY	7 ITEM NAME	8 BRAND / MAKE MANUFACTURER	9 MODEL NAME OR NUMBER	10 MISC. DESCRIPTION	11 IDENTIFICATION / SERIAL NUMBER	12 VALUE
--------	--------	-------	-------------	-----------------------------	------------------------	----------------------	-----------------------------------	----------

- Supplemental
 Case Cleared
 Reclassification
 Gang
 Domestic
 Hate
 Child Abuse
 Elderly Abuse
 ARRC

Connecting Report Numbers:

Code Section / Description: Officer Involved Shooting

Code: S Name: Canley, Adrian

On 11-14-06, I responded to a report of an officer involved shooting at [REDACTED] in Thousand Oaks. While at the scene, Captain R. Pentis asked me to escort Senior Deputy Matthews to the East County Sheriff's Station to await investigators and his legal representation. At about 1905 hours, Senior Deputy Matthews and I left the scene in my department vehicle. We drove directly to the station and arrived at about 1917 hours.

I remained with Senior Deputy Matthews until attorney Rick Shimmel arrived at the station at about 1955 hours. Shimmel then spoke with Senior Deputy Matthews privately in the detective conference room. During my time with Senior Deputy Matthews, he did not discuss the details of the incident with anyone.

Major Crimes Detectives Davidson and Powers, Internal Affairs Captain O'Hanlon, Internal Affairs Detectives Murray and Inglis, and Doctor Katz arrived at the station while Senior Deputy Matthews was speaking with Shimmel. At about 2345 hours, Captain O'Hanlon informed me that Senior Deputy Matthews was going to be transported back to the scene. Captain O'Hanlon informed me that transportation arrangements had already been made and I would no longer be needed.

13 DATE / TIME OF REPORT 11/15/06 / 10:02	14 REPORTING OFFICER / ID NO / DIV / UNIT J. MILLER #3056 / ECPS / DETS	15 APPROVED BY / ID NO  / 2486
--	--	--

NARRATIVE REPORT VENTURA COUNTY SHERIFF'S DEPARTMENT

Page 1 of 1 Continuation

AGENCY IDENTIFIER CA0560000

1 PD **9072**

2 BEAT **95**

3 RD NUMBER **08-30492**

4 CODE	5 ITEM	6 QTY	7 ITEM NAME	8 BRAND / MAKE MANUFACTURER	9 MODEL NAME OR NUMBER	10 MISC. DESCRIPTION	11 IDENTIFICATION / SERIAL NUMBER	12 VALUE
--------	--------	-------	-------------	-----------------------------	------------------------	----------------------	-----------------------------------	----------

- Supplemental
 Case Closed
 Reclassification
 Domestic
 Child Abuse
 Hate
 Gang
 Elderly Abuse
 ARRC

Connecting Report Numbers:

Code Section / Description: **245(a)(1) P.C. Assault with a Deadly Weapon**

Code Section / Description (Reclassify To:)

Code: **S** Name: **Canley, Adrian Doyle**

Background

I am the supervisor in charge of the city of Thousand Oaks, East County, Special Enforcement / Gang Unit. I received a cell phone call from unit member Senior Deputy Gus Macias. Macias advised me that an officer involved shooting had occurred at [REDACTED] in Thousand Oaks.

I arrived at the Los Feliz scene and checked in with the command post at 1915 hrs. I cell phoned Special Enforcement Senior Deputy Dan Hawes and requested he respond to Los Robles Hospital to assist in identifying the injured suspect. I cell phoned Special Enforcement Deputy Brian Baker to have him respond to the Los Feliz scene and assist with interviews.

While I was on scene I was in phone contact with Special Enforcement Administrative Aide [REDACTED]. At my request she provided me with information on the suspect, Adrian Canley, that she obtained through law enforcement electronic media. I provided this information to various on scene investigators.

I never entered the shooting scene perimeter nor did I collect any evidence from the area. I did notice a black Ford Mustang ([REDACTED]) parked inside the shooting perimeter. This car belongs to Richard Escobar a former Thousand Oaks gang associate. I checked out from the command post at 2145 hrs.

13 DATE / TIME OF REPORT 11/15/2006 9:21 AM	14 REPORTING OFFICER (ID NO. / DIV. / UNIT) M. O'Donnell, Sgt., 1354 / ECPS / SEU	15 APPROVED BY / ID NO. Sr. Det. D. Hawes 2261
---	---	--

CRIME / INCIDENT REPORT

VENTURA COUNTY SHERIFF'S DEPARTMENT

AGENCY IDENTIFIER CA0560000

1 CONNECTING REPORT NUMBERS		2 RD	3 BEAT	4 RB NUMBER
		1072	96	06 30492

5 CRIME INCIDENT SUPPLEMENTAL 6 DOMESTIC CHILD ABUSE HATE
 CASE CLOSED RECLASSIFICATION GANG ELDERLY ABUSE ARRC

7 CODE SECTION / DESCRIPTION (INCIDENT) OFFICER INVOLVED SHOOTING	8 CLASS. <input type="checkbox"/> Misd. <input type="checkbox"/> Fel.	9 CODE SECTION / DESCRIPTION (<input type="checkbox"/> Reclassify To:)	10 CLASS. <input type="checkbox"/> Misd. <input type="checkbox"/> Fel.
11 CODE SECTION / DESCRIPTION (INCIDENT)	12 CLASS. <input type="checkbox"/> Misd. <input type="checkbox"/> Fel.	13 CODE SECTION / DESCRIPTION (<input type="checkbox"/> Reclassify To:)	14 CLASS. <input type="checkbox"/> Misd. <input type="checkbox"/> Fel.
15 OCCURRED FROM	16 DOW	17 OCCURRED TO	18 DOW

19 LOCATION OF OFFENSE / INCIDENT ADDRESS CITY STATE ZIP

43 CODE	44 NAME (Last, First, Middle, Gen.) / FIRM NAME	AKA / Moniker	RACE	SEX	HT	WT	HAIR	EYES	DOB	AGE	
53 RESIDENCE ADDRESS / (<input type="checkbox"/> Same as Box # _____)							CITY	STATE	ZIP	54 RESIDENCE PHONE ()	
55 BUSINESS / SCHOOL NAME							ADDRESS / (<input type="checkbox"/> Same as Box # _____)	CITY	STATE	ZIP	56 BUSINESS PHONE ()
57 OCCUPATION (<input type="checkbox"/> STUDENT)			58 DAYS OFF	59 WORK HRS	60 INTERPRETER	61 OPERATOR'S LIC. NO. / STATE					
62 VEH. LIC. NO. / STATE		63 VEH. COLOR / YEAR	MAKE /	MODEL /	BODY STYLE	64 OTHER CHARACTERISTICS / VIN NO.					

65 <u>ARSON</u> <input type="checkbox"/> Single Family Resd. <input type="checkbox"/> Inhabited <input type="checkbox"/> Uninhabited <input type="checkbox"/> Storage <input type="checkbox"/> Industrial <input type="checkbox"/> Commercial <input type="checkbox"/> Other Structure <input type="checkbox"/> Public Place <input type="checkbox"/> Vehicle <input type="checkbox"/> Unlawful Fire <input type="checkbox"/> Forest <input type="checkbox"/> Injury Occurred <input type="checkbox"/> Other	66 <u>BURGLARY</u> <input type="checkbox"/> Residential <input type="checkbox"/> Vehicle <input type="checkbox"/> Commercial <input type="checkbox"/> Other	67 <u>ROBBERY</u> <input type="checkbox"/> Bank <input type="checkbox"/> Chain Store <input type="checkbox"/> Commercial <input type="checkbox"/> Gas Station <input type="checkbox"/> Highway <input type="checkbox"/> Residence <input type="checkbox"/> Other	68 <u>THEFT</u> <input type="checkbox"/> Auto Parts <input type="checkbox"/> Bicycle <input type="checkbox"/> From Building <input type="checkbox"/> Coin Machine <input type="checkbox"/> From Person <input type="checkbox"/> From Vehicle <input type="checkbox"/> Purse Snatch <input type="checkbox"/> Shoplift <input type="checkbox"/> Other	69 <u>VALUE / DOLLAR LOSS</u> \$ _____ <u>VALUE / DAMAGE LOSS</u> \$ _____	70 <u>FORCE / WEAPON</u> <input type="checkbox"/> No Force <input type="checkbox"/> No Weapon <input type="checkbox"/> Verbal Only <input type="checkbox"/> Attempt Only <input type="checkbox"/> Great Bodily Injury <input type="checkbox"/> Firearm <input type="checkbox"/> Knife <input type="checkbox"/> Hands/Fists/Feet <input type="checkbox"/> Other	71 <u>DOMESTIC VIOLENCE / STALKING / SEX / HATE CRIMES</u> <input type="checkbox"/> Per 264.2 PC, "Victims of Domestic Violence" pamphlet given to: <input type="checkbox"/> VICTIM (Includes sexual assault victims) <input type="checkbox"/> P-1 <input type="checkbox"/> P-2 <input type="checkbox"/> Per 6254 GC, Victims of DV, Stalking, Sex or Hate Crime requests his/her name be <u>withheld</u> from the public. <input type="checkbox"/> YES <input type="checkbox"/> NO	72 <u>SPECIAL INTEREST</u> (Copy to Agency/Unit) <input type="checkbox"/> Domestic Violence <input type="checkbox"/> Sex Crime <input type="checkbox"/> Child Abuse <input type="checkbox"/> HSA <input type="checkbox"/> Gang Related <input type="checkbox"/> Hate Crime <input type="checkbox"/> Agricultural <input type="checkbox"/> Probation <input type="checkbox"/> Parole <input type="checkbox"/> Other
---	---	---	--	---	---	--	---

73 DATE AND TIME REPORTED 11-15-06 / 1821	74 DATE / TIME OF REPORT 11-15-06 / 0054	75 REPORTING OFFICER / ID NO. / DIV / UNIT HAWTHORNE / 3384 / KCPD	76 APPROVED BY / ID NO. A. J. [Signature]
77 COPIES TO <input type="checkbox"/> DET / MC <input type="checkbox"/> NARC <input type="checkbox"/> GANG / SEU <input type="checkbox"/> STATS <input type="checkbox"/> PRESS <input type="checkbox"/> DOJ <input type="checkbox"/> COURT			

NARRATIVE REPORT VENTURA COUNTY SHERIFF'S DEPARTMENT

Page 1 of 2 Continuation

AGENCY IDENTIFIER CA0560000

1 RD 9072	2 BEAT 96	3 RB NUMBER 06-30492
--------------	--------------	-------------------------

4 CCODE	5 ITEM	6 QTY.	7 ITEM NAME	8 BRAND / MAKE MANUFACTURER	9 MODEL NAME OR NUMBER	10 MISC. DESCRIPTION	11 IDENTIFICATION / SERIAL NUMBER	12 VALUE
---------	--------	--------	-------------	-----------------------------	------------------------	----------------------	-----------------------------------	----------

On 11-14-06, at about 1827 hours, I responded to the area of [REDACTED] in Thousand Oaks reference a shooting. I arrived and assisted Deputy Jones and Tutino with checking Thousand Oaks Boulevard for a white "Bronco" type vehicle, which was possibly involved in the incident.

After checking the area with negative results, I responded to the location of the shooting and contacted Senior Deputy Smith. He requested I respond to Los Robles Hospital, 215 West Janss Road in Thousand Oaks, and stand by with a subject, later identified as Adrian Doyle Canley, who was involved in the incident. AMR Ambulance had transported Canley to the hospital before my arrival on scene.

I responded to the hospital and stood by in the treatment room where Canley was being treated by medical staff for a gunshot wound. Canley was unconscious the entire time I stood by with him.

I spoke with AMR Paramedic [REDACTED] and her partner, EMT [REDACTED] and [REDACTED] are assigned to unit #452 and were the ambulance crew dispatched to the scene of the shooting.

I spoke with Firefighter Paramedic [REDACTED] who is assigned to the Ventura County Fire Department Squad #31. [REDACTED] gave me the following list of Firefighters who responded to the scene of the shooting. All belong to Squad #31.

- Firefighter Paramedic [REDACTED]
- Firefighter [REDACTED]
- Engineer [REDACTED]
- Captain [REDACTED]

Deputy Bugarin arrived to assist. She obtained a complete statement from [REDACTED]. Refer to her report for further.

Bugarin stood by in the treatment room with Canley while I obtained a brief tape-recorded statement from [REDACTED]. I later conducted a brief

13 DATE / TIME OF REPORT 11-15-06 10628	14 REPORTING OFFICER / ID NO / DIV / UNIT HAWTHORNE / 3384 / ECPS	15 APPROVED BY / ID NO <i>[Signature]</i>
--	--	--

NARRATIVE REPORT VENTURA COUNTY SHERIFF'S DEPARTMENT

Page 2 of 2 Continuation

AGENCY IDENTIFIER CA0560000

1 RD 9072	2 BEAT 96	3 RD NUMBER 06-30492
--------------	--------------	-------------------------

4 CODE	5 ITEM	6 QTY	7 ITEM NAME	8 BRAND / MAKE MANUFACTURER	9 MODEL NAME OR NUMBER	10 MISC. DESCRIPTION	11 IDENTIFICATION / SERIAL NUMBER	12 VALUE
--------	--------	-------	-------------	-----------------------------	------------------------	----------------------	-----------------------------------	----------

supplemental second interview with [REDACTED] regarding the incident. The following is summary of his statements.

He is an EMT assigned to unit #452. He arrived on scene and saw a subject lying on the ground near a white pick-up truck. The subject was unresponsive and being treated by the Fire Department (Squad 31) who had intubated him.

[REDACTED] did not treat the subject and only assisted with placing him onto a backboard. He said he saw a gun lying on the ground on the outside of his right leg. He said the gun was a black "Glock" and was lying inside his cut open pants. [REDACTED] then transported the subject by ambulance to the hospital.

I returned to the treatment room and stood by while medical staff treated Canley.

Major Crimes Detective Peterson arrived at the hospital. He obtained complete statements from the Fire Department and AMR personnel.

At 2013 hours, Doctor [REDACTED] pronounced Canley dead. At about 2052 hours, Medical Examiner Craig Stevens arrived at the hospital. A short time later, Crime Scene Technicians [REDACTED] and [REDACTED] arrived.

I stood by with Canley until his body was removed from the hospital by the Coroner's office.

My cassette-tape was booked as evidence at the East County Property Room.

13 DATE / TIME OF REPORT 11-15-06/0629	14 REPORTING OFFICER / ID NO / DIV / UNIT HAWTHORNE/13384/ECPS	15 APPROVED BY / SIGNATURE A. [Signature]
---	---	--

CRIME / INCIDENT REPORT

VENTURA COUNTY SHERIFF'S DEPARTMENT
AGENCY IDENTIFIER CA0560000

1 CONNECTING REPORT NUMBERS		2 RD 9072	3 BEAT 96	4 RB NUMBER 06-30492
-----------------------------	--	--------------	--------------	-------------------------

5 <input type="checkbox"/> CRIME <input type="checkbox"/> INCIDENT <input checked="" type="checkbox"/> SUPPLEMENTAL	6 <input type="checkbox"/> DOMESTIC <input type="checkbox"/> CHILD ABUSE <input type="checkbox"/> HATE
<input type="checkbox"/> CASE CLOSED <input type="checkbox"/> RECLASSIFICATION	<input type="checkbox"/> GANG <input type="checkbox"/> ELDERLY ABUSE <input type="checkbox"/> ARRC

7 CODE SECTION / DESCRIPTION (INCIDENT) OFFICER INVOLVED SHOOTING	8 CLASS <input type="checkbox"/> Misd <input type="checkbox"/> Fel	9 CODE SECTION / DESCRIPTION (<input type="checkbox"/> Reclassify To:)	10 CLASS <input type="checkbox"/> Misd <input type="checkbox"/> Fel
11 CODE SECTION / DESCRIPTION (INCIDENT)	12 CLASS <input type="checkbox"/> Misd <input type="checkbox"/> Fel	13 CODE SECTION / DESCRIPTION (<input type="checkbox"/> Reclassify To:)	14 CLASS <input type="checkbox"/> Misd <input type="checkbox"/> Fel

15 OCCURRED FROM MO. DAY YR. TIME 11 14 06 1820	16 DOW TUE	17 OCCURRED TO MO. DAY YR. TIME 11 14 06 1821	18 DOW TUE
---	---------------	---	---------------

19 LOCATION OF OFFENSE / INCIDENT ADDRESS CITY STATE ZIP

20 CODE: V - VICTIM W - WITNESS R - REPORTING PARTY F - FINDER O - OWNER P - PARTY

21 CODE P	22 NAME (Last, First, Middle, Gen.) / FIRM NAME CANLEY, ADRIAN	AKA / Moniker	RACE	SEX	25 HT	26 WT	27 HAIR	28 EYES	29 DOB	30 AGE
--------------	---	---------------	------	-----	-------	-------	---------	---------	--------	--------

31 RESIDENCE ADDRESS / (<input type="checkbox"/> Same as Box # _____)	CITY	STATE	ZIP	32 RESIDENCE PHONE ()
---	------	-------	-----	---------------------------

33 BUSINESS / SCHOOL NAME	ADDRESS / (<input type="checkbox"/> Same as Box # _____)	CITY	STATE	ZIP	34 BUSINESS PHONE ()
---------------------------	--	------	-------	-----	--------------------------

35 OCCUPATION (<input type="checkbox"/> STUDENT)	36 DAYS OFF	37 WORK HRS	38 INTERPRETER	39 OPERATOR'S LIC. NO. / STATE
--	-------------	-------------	----------------	--------------------------------

40 VEH. LIC. NO. / STATE	41 VEH. COLOR / YEAR / MAKE / MODEL / BODY STYLE	42 OTHER CHARACTERISTICS / VIN NO.
--------------------------	--	------------------------------------

43 CODE	44 NAME (Last, First, Middle, Gen.) / FIRM NAME	AKA / Moniker	RACE	SEX	47 HT	48 WT	49 HAIR	50 EYES	51 DOB	52 AGE
---------	---	---------------	------	-----	-------	-------	---------	---------	--------	--------

53 RESIDENCE ADDRESS / (<input type="checkbox"/> Same as Box # _____)	CITY	STATE	ZIP	54 RESIDENCE PHONE ()
---	------	-------	-----	---------------------------

55 BUSINESS / SCHOOL NAME	ADDRESS / (<input type="checkbox"/> Same as Box # _____)	CITY	STATE	ZIP	56 BUSINESS PHONE ()
---------------------------	--	------	-------	-----	--------------------------

57 OCCUPATION (<input type="checkbox"/> STUDENT)	58 DAYS OFF	59 WORK HRS	60 INTERPRETER	61 OPERATOR'S LIC. NO. / STATE
--	-------------	-------------	----------------	--------------------------------

62 VEH. LIC. NO. / STATE	63 VEH. COLOR / YEAR / MAKE / MODEL / BODY STYLE	64 OTHER CHARACTERISTICS / VIN NO.
--------------------------	--	------------------------------------

65 ARSON <input type="checkbox"/> Single Family Resd. <input type="checkbox"/> Inhabited <input type="checkbox"/> Uninhabited <input type="checkbox"/> Storage <input type="checkbox"/> Industrial <input type="checkbox"/> Commercial <input type="checkbox"/> Other Structure <input type="checkbox"/> Public Place <input type="checkbox"/> Vehicle <input type="checkbox"/> Unlawful Fire <input type="checkbox"/> Forest <input type="checkbox"/> Injury Occurred <input type="checkbox"/> Other	66 BURGLARY <input type="checkbox"/> Residential <input type="checkbox"/> Vehicle <input type="checkbox"/> Commercial <input type="checkbox"/> Other 67 ROBBERY <input type="checkbox"/> Bank <input type="checkbox"/> Chain Store <input type="checkbox"/> Commercial <input type="checkbox"/> Gas Station <input type="checkbox"/> Highway <input type="checkbox"/> Residence <input type="checkbox"/> Other	68 THEFT <input type="checkbox"/> Auto Parts <input type="checkbox"/> Bicycle <input type="checkbox"/> From Building <input type="checkbox"/> Coin Machine <input type="checkbox"/> From Person <input type="checkbox"/> From Vehicle <input type="checkbox"/> Purse Snatch <input type="checkbox"/> Shoplift <input type="checkbox"/> Other 69 VALUE / DOLLAR LOSS \$ _____ VALUE / DAMAGE LOSS \$ _____	70 FORCE / WEAPON <input type="checkbox"/> No Force <input type="checkbox"/> No Weapon <input type="checkbox"/> Verbal Only <input type="checkbox"/> Attempt Only <input type="checkbox"/> Great Bodily Injury <input type="checkbox"/> Firearm <input type="checkbox"/> Knife <input type="checkbox"/> Hands/Fists/Feet <input type="checkbox"/> Other	72 SPECIAL INTEREST (Copy to Agency/Unit) <input type="checkbox"/> Domestic Violence <input type="checkbox"/> Sex Crime <input type="checkbox"/> Child Abuse <input type="checkbox"/> HSA <input type="checkbox"/> Gang Related <input type="checkbox"/> Hate Crime <input type="checkbox"/> Agricultural <input type="checkbox"/> Probation <input type="checkbox"/> Parole <input checked="" type="checkbox"/> Other MAJOR CRIMES
--	--	--	--	--

73 DATE AND TIME REPORTED 11-14-06 / 1821	74 DATE / TIME OF REPORT 11-15-06 / 0230	75 REPORTING OFFICER / ID NO. / DIV. / UNIT TOTEND / 3273 / ECP5	76 APPROVED BY / ID NO. A. Dogan / 1086
--	---	---	--

77 COPIES TO DET / MC NARC GANG / SEU STATS PRESS DOJ COURT

NARRATIVE REPORT VENTURA COUNTY SHERIFF'S DEPARTMENT

Page 3 of 3 Continuation

AGENCY IDENTIFIER CA0560000

1 RD 9072	2 BEAT 96	3 RB NUMBER 06-30492
--------------	--------------	-------------------------

4 CODE	5 ITEM	6 QTY	7 ITEM NAME	8 BRAND / MAKE MANUFACTURER	9 MODEL NAME OR NUMBER	10 MISC. DESCRIPTION	11 IDENTIFICATION / SERIAL NUMBER	12 VALUE
--------	--------	-------	-------------	-----------------------------	------------------------	----------------------	-----------------------------------	----------

On 11-14-06, at 1821 hours, I responded to [REDACTED] reference an officer involved shooting that occurred at the location. I arrived and was assigned to keep a crime scene log for the inner perimeter.

I maintained that log until approximately 0200 hours when the crime scene was taken down. I gave the log I kept to Sgt. Peterson at the scene prior to leaving.

In addition, I accepted the CHP 180 from Deputy Natoli. Once the tow company arrived, the suspect's truck was signed for and towed by McCoy's Towing of Santa Paula. Sr. Deputy Keller sealed the truck before the truck left. The tow form was turned in with this report.

13 DATE / TIME OF REPORT 11-15-06 / 0200	14 REPORTING OFFICER / ID NO / DIV / UNIT TUTINO / 3273 / ECPS	15 APPROVED / ID NO <i>[Signature]</i>
---	---	---

CRIME / INCIDENT REPORT

VENTURA COUNTY SHERIFF'S DEPARTMENT
AGENCY IDENTIFIER CA0560000

1 CONNECTING REPORT NUMBERS:		2 RD 9072	3 BEAT 96	4 RB NUMBER 06-30492	
5 <input type="checkbox"/> CRIME <input type="checkbox"/> INCIDENT <input checked="" type="checkbox"/> SUPPLEMENTAL		6 <input type="checkbox"/> DOMESTIC <input type="checkbox"/> CHILD ABUSE <input type="checkbox"/> HATE <input type="checkbox"/> CASE CLOSED <input type="checkbox"/> RECLASSIFICATION <input type="checkbox"/> _____ <input type="checkbox"/> GANG <input type="checkbox"/> ELDERLY ABUSE <input type="checkbox"/> ARRC			
7 CODE SECTION / DESCRIPTION (INCIDENT) 245 P.C. / ADW. PEACH OFFICER		8 CLASS <input type="checkbox"/> Misd. <input checked="" type="checkbox"/> Fel.	9 CODE SECTION / DESCRIPTION (<input type="checkbox"/> Reclassify To:)		
11 CODE SECTION / DESCRIPTION (INCIDENT) _____		12 CLASS <input type="checkbox"/> Misd. <input type="checkbox"/> Fel.	13 CODE SECTION / DESCRIPTION (<input type="checkbox"/> Reclassify To:)		
15 OCCURRED FROM	MO. DAY YR. TIME 11 14 06 1841	16 DOW TUES	17 OCCURRED TO	18 DOW	
19 LOCATION OF OFFENSE / INCIDENT ADDRESS		CITY	STATE	ZIP	
20 CODE: V - VICTIM W - WITNESS R - REPORTING PARTY F - FINDER O - OWNER P - PARTY					
21 CODE V	22 NAME (Last, First, Middle, Gen.) / FIRM NAME MATTHEWS, SHANE	23 RACE	24 SEX	25 HT	
31 RESIDENCE ADDRESS / (<input type="checkbox"/> Same as Box # _____)		CITY	STATE	ZIP	
33 BUSINESS / SCHOOL NAME ADDRESS / (<input type="checkbox"/> Same as Box # _____)		CITY	STATE	ZIP	
35 OCCUPATION (<input type="checkbox"/> STUDENT)		36 DAYS OFF	37 WORK HRS	38 INTERPRETER	
40 VEH. LIC. NO. / STATE	41 VEH. COLOR / YEAR / MAKE / MODEL / BODY STYLE	42 OTHER CHARACTERISTICS / VIN NO.			
43 CODE	44 NAME (Last, First, Middle, Gen.) / FIRM NAME	45 RACE	46 SEX	47 HT	
53 RESIDENCE ADDRESS / (<input type="checkbox"/> Same as Box # _____)		CITY	STATE	ZIP	
55 BUSINESS / SCHOOL NAME ADDRESS / (<input type="checkbox"/> Same as Box # _____)		CITY	STATE	ZIP	
57 OCCUPATION (<input type="checkbox"/> STUDENT)		58 DAYS OFF	59 WORK HRS	60 INTERPRETER	
62 VEH. LIC. NO. / STATE	63 VEH. COLOR / YEAR / MAKE / MODEL / BODY STYLE	64 OTHER CHARACTERISTICS / VIN NO.			
65 ARSON <input type="checkbox"/> Single Family Resd. <input type="checkbox"/> Inhabited <input type="checkbox"/> Uninhabited <input type="checkbox"/> Storage <input type="checkbox"/> Industrial <input type="checkbox"/> Commercial <input type="checkbox"/> Other Structure <input type="checkbox"/> Public Place <input type="checkbox"/> Vehicle <input type="checkbox"/> Unlawful Fire <input type="checkbox"/> Forest <input type="checkbox"/> Injury Occurred <input type="checkbox"/> Other		66 BURGLARY <input type="checkbox"/> Residential <input type="checkbox"/> Vehicle <input type="checkbox"/> Commercial <input type="checkbox"/> Other		67 ROBBERY <input type="checkbox"/> Bank <input type="checkbox"/> Chain Store <input type="checkbox"/> Commercial <input type="checkbox"/> Gas Station <input type="checkbox"/> Highway <input type="checkbox"/> Residence <input type="checkbox"/> Other	
68 THEFT <input type="checkbox"/> Auto Parts <input type="checkbox"/> Bicycle <input type="checkbox"/> From Building <input type="checkbox"/> Coin Machine <input type="checkbox"/> From Person <input type="checkbox"/> From Vehicle <input type="checkbox"/> Purse Snatch <input type="checkbox"/> Shoplift <input type="checkbox"/> Other		69 VALUE / DOLLAR LOSS \$ _____ VALUE / DAMAGE LOSS \$ _____		70 FORCE / WEAPON <input type="checkbox"/> No Force <input type="checkbox"/> No Weapon <input type="checkbox"/> Verbal Only <input type="checkbox"/> Attempt Only <input type="checkbox"/> Great Bodily Injury <input type="checkbox"/> Firearm <input type="checkbox"/> Knife <input type="checkbox"/> Hands/Fists/Feet <input type="checkbox"/> Other	
71 DOMESTIC VIOLENCE / STALKING / SEX / HATE CRIMES <input type="checkbox"/> Per 264.2 PC, "Victims of Domestic Violence" pamphlet given to: <input type="checkbox"/> VICTIM (Includes sexual assault victims) <input type="checkbox"/> P-1 <input type="checkbox"/> P-2 <input type="checkbox"/> Per 6254 GC, Victim of DV, Stalking, Sex or Hate Crime requests his/her name be withheld from the public. <input type="checkbox"/> YES <input type="checkbox"/> NO		72 SPECIAL INTEREST (Copy to Agency/Unit) <input type="checkbox"/> Domestic Violence <input type="checkbox"/> Sex Crime <input type="checkbox"/> Child Abuse <input type="checkbox"/> HSA <input type="checkbox"/> Gang Related <input type="checkbox"/> Hate Crime <input type="checkbox"/> Agricultural <input type="checkbox"/> Probation <input type="checkbox"/> Parole <input type="checkbox"/> Other			
73 DATE AND TIME REPORTED 11-14-06 / 1841 HRS	74 DATE / TIME OF REPORT 11-16-06 / 1400 HRS	75 REPORTING OFFICER / ID NO. / DIV. / UNIT MA10 / 2883 / ECPS		76 APPROVED BY / ID NO. [Signature] / 12486	
77 COPIES TO <input type="checkbox"/> DET / MC <input type="checkbox"/> NARC <input type="checkbox"/> GANG / SEU <input type="checkbox"/> STATS <input type="checkbox"/> PRESS <input type="checkbox"/> DOJ <input type="checkbox"/> COURT _____					

NARRATIVE REPORT VENTURA COUNTY SHERIFF'S DEPARTMENT

Page 1 of 3 Continuation

AGENCY IDENTIFIER CA0560000

1 RD 9072	2 BEAT 9G01	3 RS NUMBER 2006-30492
--------------	----------------	---------------------------

4 CODE	5 ITEM	6 QTY	7 ITEM NAME	8 BRAND / MAKE MANUFACTURER	9 MODEL NAME OR NUMBER	10 MISC DESCRIPTION	11 IDENTIFICATION / SERIAL NUMBER	12 VALUE
--------	--------	-------	-------------	-----------------------------	------------------------	---------------------	-----------------------------------	----------

- Supplemental Case Cleared
 Gang Domestic Hate Child Abuse Elderly Abuse

Connecting Report Numbers:

Code Section / Description: 245(c) P.C.

Reclassify to:

Code: S-1 Name: Canley, Adrian

Notification and Response

On 11/14/06, at approximately 1830 hours, I was driving home in the city of Moorpark in my department issued detective vehicle, when I heard Sheriff's Dispatch advise that a shooting had occurred in Thousand Oaks on Los Feliz Drive and Detective Matthews was involved. I telephoned and spoke with Detective Smith and advised him of the incident. Smith stated that he and Detective Miller would respond to the scene from the Thousand Oaks police station.

I immediately began driving from the city of Moorpark to the location of the incident at [REDACTED]

I arrived at the above location at approximately 1835 hours. I saw several patrol units, an AMR ambulance, and a Ventura County Fire Engine from station # 31 already on scene. I saw fire and paramedic personnel administering first aid to a male on the ground outside of a white Ford pickup truck.

I located Detective Matthews in the circular portion of the driveway just east of the Fire Engine; he was standing behind some yellow police tape watching the fire and paramedic personnel. I approached Det. Matthews and asked him if he was "Ok" and needed anything. Det. Matthews stated that he was "Ok" and did not need anything.

13 DATE / TIME OF REPORT 12-04-06 / 0912	14 REPORTING OFFICER / ID NO / DV / UNIT Det. M. Harris/#3713/East County Invest.	15 APPROVED BY / ID NO <i>[Signature]</i>
---	--	--

NARRATIVE REPORT VENTURA COUNTY SHERIFF'S DEPARTMENT

Page 2 of 3 Continuation

AGENCY IDENTIFIER CA0560000

1 RD 9072	2 BEAT 9G01	3 RB NUMBER 2006-30492
--------------	----------------	---------------------------

4 CODE	5 ITEM	6 QTY.	7 ITEM NAME	8 BRAND / MAKE MANUFACTURER	9 MODEL NAME OR NUMBER	10 MISC. DESCRIPTION	11 IDENTIFICATION / SERIAL NUMBER	12 VALUE
--------	--------	--------	-------------	-----------------------------	------------------------	----------------------	-----------------------------------	----------

Deputy Berg then approached me and stated that fire personnel had located a gun on the subject beside the Ford truck. Deputy Berg asked that I come witness the location of the handgun before he secured the gun. I walked with Deputy Berg to the front of the Ford pickup truck. I saw a male lying on his back with his feet towards the front of the truck and his head towards the rear of the truck. I saw a pair of blue jeans hand been cut the entire length of the legs and laid open. Beside the subject's right leg, mid thigh area, I saw a black handgun. The handle of the handgun was towards the waistband of the pants and the barrel was pointed down towards the right leg. Deputy Berg began to step towards the subject and secure the weapon, since Fire personnel were still administering first aid to the subject. I asked Deputy Berg if he had a camera to photograph the location of the gun prior to it being secured. Deputy Berg stated that he did not have a camera and asked Deputy Natoli to bring her camera.

As we were preparing to take photographs of the location, Sergeant Peterson arrived and took over scene control. I believe photographs were taken but they did not occur prior to my leaving the area.

I walked back over to Det. Matthews, who was speaking with Det. Smith. I again asked Det. Matthews if he needed anything or needed me to contact anyone for him. Det. Matthews stated that he was fine. Det. Smith advised Det. Matthews to have a seat away from the incident. I told Det. Matthews that he could have a seat in my vehicle, which was parked nearby. Det. Matthews agreed to have a seat in the front seat of my vehicle. Det. Smith told me to open my vehicle for Det. Matthews and then to remain outside. I complied with Det. Smith's request.

After several minutes, Sergeant Powers arrived and requested to speak with Det. Matthews. I accompanied Det. Matthews while he spoke with Sergeant Powers. (Refer to Sgt. Powers' report for details of their conversation) After their conversation Sergeant Powers directed Det. Matthews to be transported to the Thousand Oaks police station.

13 DATE / TIME OF REPORT 12-04-06 / 0913	14 REPORTING OFFICER / ID NO / DIV / UNIT Det. M. Harris/#3713/East County Invest.	15 APPROVED BY / ID NO <i>[Signature]</i>
---	---	--

NARRATIVE REPORT VENTURA COUNTY SHERIFF'S DEPARTMENT

Page 3 of 3 Continuation

AGENCY IDENTIFIER CA0560000

1 RD 9072	2 BEAT 9G01	3 RB NUMBER 2006-30492
--------------	----------------	---------------------------

4 CODE	5 ITEM	6 QTY	7 ITEM NAME	8 BRAND / MAKE MANUFACTURER	9 MODEL NAME OR NUMBER	10 MISC DESCRIPTION	11 IDENTIFICATION / SERIAL NUMBER	12 VALUE
--------	--------	-------	-------------	-----------------------------	------------------------	---------------------	-----------------------------------	----------

Prior to Det. Matthews leaving the area, he gave me the keys to his detective van and asked that I make sure to secure his AR-15 and shotgun from inside his vehicle. I retrieved the AR-15 and shotgun from Det. Matthews's vehicle and placed them in the trunk of my detective unit. I gave the keys to Det. Matthews's vehicle to Sgt. Powers.

Det. Miller escorted Det. Matthews to the Thousand Oaks police station.

Once Det. Matthews left the location, Sergeant Powers directed Sergeant Weaver to coordinate a canvas of the area for witnesses. Sgt. Weaver directed Det. Alvarez and me to canvas the rear apartment building for witnesses.

Refer to my other interviews for further details.

13 DATE / TIME OF REPORT 12-04-06 / 0914	14 REPORTING OFFICER / ID NO. / DIV / UNIT Det. M. Harris/#3713/East County Invest.	15 APPROVED BY / ID NO. <i>J. [Signature]</i> / 2486
---	--	---

NARRATIVE REPORT VENTURA COUNTY SHERIFF'S DEPARTMENT

Page 1 of 6 Continuation

AGENCY IDENTIFIER CA0560000

1 RD 9072	2 BEAT 9G01	3 RB NUMBER 2006-30492
--------------	----------------	---------------------------

4 CODE	5 ITEM	6 QTY	7 ITEM NAME	8 BRAND / MAKE MANUFACTURER	9 MODEL NAME OR NUMBER	10 MISC. DESCRIPTION	11 IDENTIFICATION / SERIAL NUMBER	12 VALUE
--------	--------	-------	-------------	-----------------------------	------------------------	----------------------	-----------------------------------	----------

Supplemental **Case Cleared**

Gang **Domestic** **Hate** **Child Abuse** **Elderly Abuse**

Connecting Report Numbers:

Code Section / Description: Officer Involved Shooting

Reclassify To:

Code: P **Name:** Canley, Adrian Doyle

Notification and Response

On November 14, 2006, at approximately 1850 hours, I was at the office of the Major Crimes Bureau in the City of Ventura when I received a telephone call from Major Crimes Detective Sergeant Rhods #1438. He directed me to respond to an officer involved shooting at [REDACTED] in the City of Thousand Oaks. Detective Sergeant Rhods did not provide additional information about the incident.

At approximately 1855 hours, while I was preparing to respond to the scene, I received a telephone call on my cellular telephone from Major Crimes Detective Captain Kelley #1822. He directed me to respond to the Los Robles Regional Medical Center Emergency Room in the City of Thousand Oaks. Detective Captain Kelley said the party of this investigation, who was later determined to be Adrian Canley, had been transported by ambulance to the medical center with a gunshot wound to his right shoulder. He directed me to coordinate the investigation at the medical center. Detective Captain Kelley did not provide additional information about the incident.

At approximately 1900 hours, I responded to the medical center from the Major Crimes Bureau arriving at approximately 1925 hours.

13 DATE / TIME OF REPORT 11/15/06/ 2:36 PM	14 REPORTING OFFICER / ID NO / DIV / UNIT Det. S. Peterson #2238 / Spl. Svcs. <i>SP</i>	15 APPROVED BY / ID NO <i>BA</i> Sgt. Ayub #3318
---	--	--

NARRATIVE REPORT VENTURA COUNTY SHERIFF'S DEPARTMENT

Page 2 of 6 Continuation

AGENCY IDENTIFIER CA0560000

1 RD 9072	2 BEAT 9G01	3 RB NUMBER 2006-30492
--------------	----------------	---------------------------

4 CODE	5 ITEM	6 QTY	7 ITEM NAME	8 BRAND / MAKE MANUFACTURER	9 MODEL NAME OR NUMBER	10 MISC. DESCRIPTION	11 IDENTIFICATION / SERIAL NUMBER	12 VALUE
--------	--------	-------	-------------	-----------------------------	------------------------	----------------------	-----------------------------------	----------

Upon arrival to the medical center I found Adrian receiving medical treatment in Room 6 of the Emergency Room. He was lying on a backboard on top of a hospital bed. Multiple physicians, nurses, firefighters, paramedics, and other medical staff were conducting the medical treatment. I also saw Deputy Hawthorne #3384, a uniformed Patrol Deputy, monitoring the activities taking place. Another uniformed Patrol Deputy, Deputy Bugarin #3651, was interviewing a paramedic, later identified to be [REDACTED], outside the Emergency Room in the sallyport area.

I contacted an unknown paramedic in the emergency room and he advised me he was not associated with this incident. However, he said he heard Adrian was "fading fast," had a "life threatening gunshot wound," and cardiopulmonary resuscitation had been preformed on him at least one time.

I then spoke to Deputy Hawthorne. He provided me the following list of Paramedics employed by American Medical Response (ambulance company) and personnel employed by the Ventura County Fire Department who had responded to the scene:

- Fire Captain [REDACTED], assigned to Fire Station 31 in Thousand Oaks.
- Fire Engineer [REDACTED], assigned to Fire Station 31 in Thousand Oaks.
- Firefighter [REDACTED], assigned to Fire Station 31 in Thousand Oaks.
- Firefighter / Paramedic [REDACTED], assigned to Fire Station 31 in Thousand Oaks.
- Firefighter / Paramedic [REDACTED], assigned to Fire Station 31 in Thousand Oaks.
- Fire Cadet [REDACTED], assigned to Fire Station 31 in Thousand Oaks.
- Paramedic [REDACTED], assigned to Unit 452 from American Medical Response.
- Emergency Medical Technician (EMT) [REDACTED], assigned to Unit 452 from American Medical Response.

Deputy Hawthorne added that Firefighter [REDACTED], Firefighter / Paramedic [REDACTED], Firefighter / Paramedic [REDACTED], Fire Cadet [REDACTED], Paramedic [REDACTED], and EMT [REDACTED] were at the

13 DATE / TIME OF REPORT 11/15/06/ 2:36 PM	14 REPORTING OFFICER / ID NO / DIV / UNIT Det. S. Peterson #2238 / Spl. Svcs. <i>SP</i>	15 APPROVED BY / ID NO Sgt. Ayub #3318 <i>BA</i>
---	--	---

NARRATIVE REPORT VENTURA COUNTY SHERIFF'S DEPARTMENT

Page 3 of 6 Continuation

AGENCY IDENTIFIER CA0560000

1 RD 9072	2 BEAT 9G01	3 RB NUMBER 2006-30492
--------------	----------------	---------------------------

4 CODE	5 ITEM	6 QTY	7 ITEM NAME	8 BRAND / MAKE MANUFACTURER	9 MODEL NAME OR NUMBER	10 MISC. DESCRIPTION	11 IDENTIFICATION / SERIAL NUMBER	12 VALUE
--------	--------	-------	-------------	-----------------------------	------------------------	----------------------	-----------------------------------	----------

medical center assisting with Adrian's medical treatment. I directed him to remain with Adrian and not leave him for any reason.

At approximately 1940 hours, I interviewed Paramedic [REDACTED]. For additional information concerning the interview, refer to my Supplemental Report titled **Witness Interview – Paramedic [REDACTED]**.

At approximately 2000 hours, Senior Deputy Hawes #2261 arrived at the medical center. He advised me he was in the process of obtaining a positive identification of Adrian. It should be noted, at that time Adrian had yet to be positively identified. I directed Senior Deputy Hawes to contact me once he had confirmed Adrian's identity.

At approximately 1958 hours, I interviewed EMT [REDACTED]. For additional information concerning the interview, refer to my Supplemental Report titled **Witness Interview – Emergency Medical Technician [REDACTED]**.

At approximately 2015 hours, I was contacted by Senior Deputy Hawes who advised me he had positively identified Adrian. For additional information concerning the information he provided me, refer to my Supplemental Report titled **Identification of Party [REDACTED]**.

At approximately 2020 hours, I was contacted by EMT [REDACTED]. He advised me that Doctor [REDACTED] had declared Adrian deceased at 2013 hours. I immediately contacted Doctor [REDACTED] and he confirmed that information. Because there were so many patients in the Emergency Room that Doctor [REDACTED] was providing medical treatment, he was unable to be interviewed.

At approximately 2025 hours, I called Major Crimes Detective Sergeant Powers #1365, who I knew was at the scene, on his cellular telephone. I advised him that Adrian had been declared deceased and he confirmed he would contact the Ventura County Medical Examiner's Office

13 DATE / TIME OF REPORT 11/15/06/ 2:36 PM	14 REPORTING OFFICER / ID NO / DIV / UNIT Det. S. Peterson #2238 / Spl. Svcs. <i>SP</i>	15 APPROVED BY / ID NO <i>BA</i> Sgt. Ayub #3318
---	--	--

NARRATIVE REPORT VENTURA COUNTY SHERIFF'S DEPARTMENT

Page 4 of 6 Continuation

AGENCY IDENTIFIER CA0560000

1 RD 9072	2 BEAT 9G01	3 RB NUMBER 2006-30492
--------------	----------------	---------------------------

4 CODE	5 ITEM	6 QTY	7 ITEM NAME	8 BRAND / MAKE MANUFACTURER	9 MODEL NAME OR NUMBER	10 MISC. DESCRIPTION	11 IDENTIFICATION / SERIAL NUMBER	12 VALUE
--------	--------	-------	-------------	-----------------------------	------------------------	----------------------	-----------------------------------	----------

and request a Deputy Medical Examiner respond to the medical center. I also advised Detective Sergeant Powers Adrian's information that Senior Deputy Hawes had provided me.

After speaking to Detective Sergeant Powers, I was contacted by Deputy Bugarin. She advised me she was completed with her part of the investigation at the medical center. I directed her to secure from the medical center and go back on patrol. I then contacted Deputy Hawthorne, who was still with Adrian in Room 6 of the Emergency Room, and directed him to remain with Adrian and not leave for any reason.

At approximately 2028 Hours, I interviewed Firefighter / EMT [REDACTED]. For additional information concerning the interview, refer to my Supplemental Report titled **Witness Interview – Firefighter / Emergency Medical Technician [REDACTED]**.

At approximately 2043 hours, I interviewed Fire Cadet [REDACTED]. For additional information concerning the interview, refer to my Supplemental Report titled **Witness Interview – Fire Cadet [REDACTED]**.

At the completion of my interview of Fire Cadet [REDACTED], I went to Room 6 in the Emergency Room where Adrian was located with Deputy Hawthorne. At that time, I saw Senior Deputy Medical Examiner Stevens, from the Ventura County Medical Examiner's Office, had arrived at the medical center. He advised me he arrived at the medical center at approximately 2052 hours while I was interviewing Fire Cadet [REDACTED]. Senior Deputy Medical Examiner Stevens advised me he was going to begin his investigation while I completed my interviews. I left him and Deputy Hawthorne in Room 6 of the Emergency Room with Adrian.

At approximately 2056 hours, I interviewed Firefighter / Paramedic [REDACTED]. For additional information concerning the interview, refer to my Supplemental Report titled **Witness Interview – Firefighter / Paramedic [REDACTED] James [REDACTED]**.

13 DATE / TIME OF REPORT 11/15/06/ 2:36 PM	14 REPORTING OFFICER / ID NO / DIV / UNIT Det. S. Peterson #2238 / Spl. Svcs.	15 APPROVED BY / ID NO Sgt. Ayub #3318
---	--	---

NARRATIVE REPORT VENTURA COUNTY SHERIFF'S DEPARTMENT

Page 5 of 6 Continuation

AGENCY IDENTIFIER CA0560000

1 RD 9072	2 BEAT 9G01	3 RB NUMBER 2006-30492
--------------	----------------	---------------------------

4 CODE	5 ITEM	6 QTY.	7 ITEM NAME	8 BRAND / MAKE MANUFACTURER	9 MODEL NAME OR NUMBER	10 MISC. DESCRIPTION	11 IDENTIFICATION / SERIAL NUMBER	12 VALUE
--------	--------	--------	-------------	-----------------------------	------------------------	----------------------	-----------------------------------	----------

At the completion of my interview of Firefighter / Paramedic [REDACTED], I called Detective Sergeant Powers at the scene on his cellular telephone. I requested he coordinate the response of a Field Evidence Technician (FET) to the medical center to process evidence. Detective Sergeant Powers advised me that FET [REDACTED] would respond to the medical center from the scene.

At approximately 2115 hours, FET Johnson and FET [REDACTED] #2963 arrived at the medical center. FET [REDACTED] advised me he would be responsible for any evidence processing that would take place. I advised him to take photographs of Adrian's body and to collect possible gunshot residue from his hands. I also informed FET [REDACTED] that medical personnel at the medical center had advised me that Adrian was completely nude when he arrived and there was no clothing to collect as evidence. However, I directed him to search Room 6 of the Emergency Room, where [REDACTED] was located, to determine if any clothing was present. Later, FET [REDACTED] advised me he found no clothing or other evidence in Room 6.

At approximately 2119 hours, I interviewed Firefighter / Paramedic [REDACTED]. For additional information concerning the interview, refer to my Supplemental Report titled **Witness Interview – Firefighter / Paramedic [REDACTED] Michael [REDACTED]**.

At approximately 2135 hours, I returned to Room 6 of the Emergency Room where Adrian's body was located. Present were Deputy Hawthorne, Senior Deputy Medical Examiner Stevens, FET J [REDACTED] and FET [REDACTED]. At that time, I conducted a visual examination of Adrian's body and took numerous digital images of him. For additional information concerning that, refer to my Supplemental Report titled **Examination of The Body of Adrian Canley**.

At approximately 2215 hours, [REDACTED] employed by Cathedral Mortuary Associates, arrived at the medical center to transport Adrian's body to the Ventura County Medical Examiner's Office. After his arrival, he assisted Senior Deputy Medical Examiner Stevens in placing Adrian's body into a body bag. For additional information

13 DATE / TIME OF REPORT 11/15/06/ 2:36 PM	14 REPORTING OFFICER / ID NO. / DIV / UNIT Det. S. Peterson #2238 / Spl. Svcs. <i>SP</i>	15 APPROVED BY / ID NO. <i>BA</i> Sgt. Ayub #3318
---	---	---

NARRATIVE REPORT VENTURA COUNTY SHERIFF'S DEPARTMENT

Page 6 of 6 Continuation

AGENCY IDENTIFIER CA0560000

1 RD 9072	2 BEAT 9G01	3 RB NUMBER 2006-30492
--------------	----------------	---------------------------

4 CODE	5 ITEM	6 QTY	7 ITEM NAME	8 BRAND / MAKE MANUFACTURER	9 MODEL NAME OR NUMBER	10 MISC. DESCRIPTION	11 IDENTIFICATION / SERIAL NUMBER	12 VALUE
--------	--------	-------	-------------	-----------------------------	------------------------	----------------------	-----------------------------------	----------

concerning that, refer to my Supplemental Report titled **Security and Transport of The Body of Adrian Canley.**

At approximately 2225 hours, FET [REDACTED] and FET [REDACTED] a secured from the medical center.

At approximately 2230 hours, Senior Deputy Medical Examiner Stevens and I secured from the medical center.

At approximately 2240 hours, I arrived at the scene located at [REDACTED]. I remained there until approximately 2320 hours when I was advised by Major Crimes Detective Sergeant Ayub #3318 that I could secure from the scene.

End of report.

13 DATE / TIME OF REPORT 11/15/06/ 2:36 PM	14 REPORTING OFFICER / ID NO. / DIV / UNIT Det. S. Peterson #2238 / Spl. Svcs.	15 APPROVED BY / ID NO. Sgt. Ayub #3318
---	---	--

ADDITIONAL NAMES
REPORT

VENTURA COUNTY SHERIFF'S DEPARTMENT
AGENCY IDENTIFIER CA0560000

Page 1 of 2

1 RB NUMBER

2006-30492

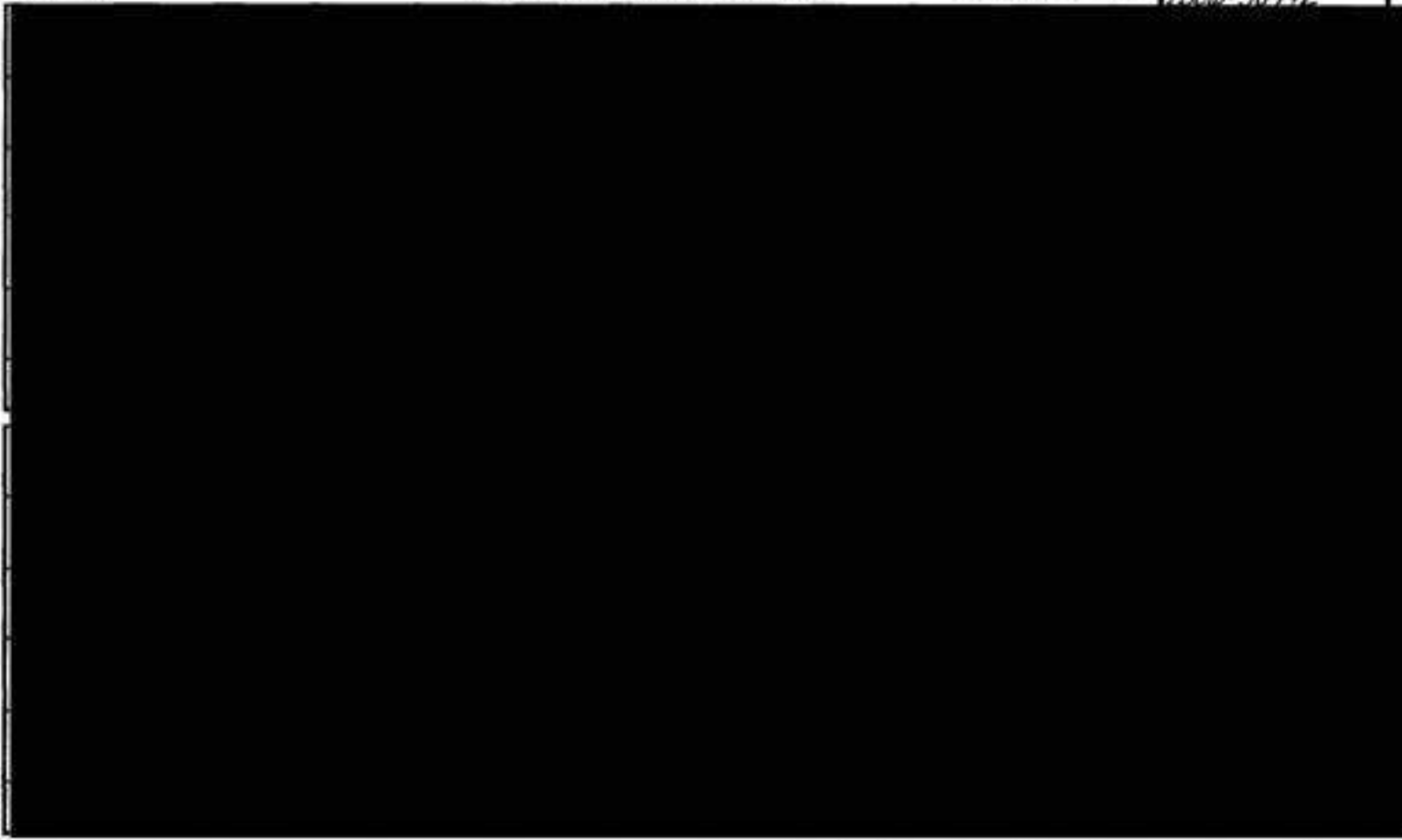

94 DATE / TIME OF REPORT <u>11-15-06 / 11700</u>	95 REPORTING OFFICER / ID NO. / DIV. / UNIT <u>DET. S. PETERSON / 7238 / MAJOR CRIMES</u>	96 APPROVED BY / ID NO. <u>Sgt. W. J. [Signature] 3318</u>
---	--	---

**ADDITIONAL NAMES
REPORT**

VENTURA COUNTY SHERIFF'S DEPARTMENT
AGENCY IDENTIFIER CA0560000

Page 2 of 2

1 RB NUMBER
2006-30492



48	49 NAME (Last, First, Middle, Gen.) / FIRM NAME	AKA / Moniker	RACE 50	SEX 51	52 HT	53 WT	54 HAIR	56 EYES	58 DOB	57 AGE
56	RESIDENCE ADDRESS / (<input type="checkbox"/> Same as Box # _____)			CITY	STATE	ZIP	59 RESIDENCE PHONE ()			
60	BUSINESS / SCHOOL NAME ADDRESS / (<input type="checkbox"/> Same as Box # _____)			CITY	STATE	ZIP	61 BUSINESS PHONE ()			
62	OCCUPATION (<input type="checkbox"/> STUDENT)	63 DAYS OFF	64 WORK HRS.	65 INTERPRETER			66 OPERATOR'S LIC. NO. / STATE			
67	VEH. LIC. NO. / STATE	68 VEH. COLOR /	YEAR /	MAKE /	MODEL /	BODY STYLE	69 OTHER CHARACTERISTICS / VIN NO.			
70 COMMENTS:										

71	72 NAME (Last, First, Middle, Gen.) / FIRM NAME	AKA / Moniker	RACE 73	SEX 74	75 HT	76 WT	77 HAIR	78 EYES	79 DOB	80 AGE
81	RESIDENCE ADDRESS / (<input type="checkbox"/> Same as Box # _____)			CITY	STATE	ZIP	82 RESIDENCE PHONE ()			
83	BUSINESS / SCHOOL NAME ADDRESS / (<input type="checkbox"/> Same as Box # _____)			CITY	STATE	ZIP	84 BUSINESS PHONE ()			
85	OCCUPATION (<input type="checkbox"/> STUDENT)	86 DAYS OFF	87 WORK HRS.	88 INTERPRETER			89 OPERATOR'S LIC. NO. / STATE			
90	VEH. LIC. NO. / STATE	91 VEH. COLOR /	YEAR /	MAKE /	MODEL /	BODY STYLE	92 OTHER CHARACTERISTICS / VIN NO.			
93 COMMENTS:										

94	DATE / TIME OF REPORT <u>11-15-06 / 1700</u>	95	REPORTING OFFICER / ID NO. / DIV. / UNIT <u>DET. S. PETERSON / 2238 / MAJOR CRIMES</u>	96	APPROVED BY / ID NO. <u>Sgt. W. J. [Signature] 3318</u>
----	---	----	---	----	--

NARRATIVE REPORT VENTURA COUNTY SHERIFF'S DEPARTMENT

Page 2 of 2 Continuation

AGENCY IDENTIFIER CA0560000

19972 9901 06-30-92

4 CODE	5 ITEM	6 QTY.	7 ITEM NAME	8 BRAND / MAKE MANUFACTURER	9 MODEL NAME OR NUMBER	10 MISC. DESCRIPTION	11 IDENTIFICATION / SERIAL NUMBER	12 VALUE
--------	--------	--------	-------------	-----------------------------	------------------------	----------------------	-----------------------------------	----------

Supplemental **Case Cleared**
 Gang **Domestic** **Hate** **Child Abuse** **Elderly Abuse**

Connecting Report Numbers:

Code Section / Description: Officer Involved Shooting

Reclassify to:

Code: P-1 **Name:** Canley, Adrian Boyle

Public Safety Questions and Inspection

On 11-14-06 at about 1830 hours, Watch Commander, Captain Tom Convery, contacted me. Captain Convery told me that there had just been an officer involved shooting at [REDACTED] and requested I respond. I responded from the North Thousand Oaks area, arriving on scene at 1844 hours.

After arriving at the scene, I located Patrol Sergeant Carey Peterson, who was the field supervisor on scene. Sergeant Peterson briefed me on the evolving situation. Sergeant Peterson told me Canley had tried to run over Detective Matthews with a white pick-up that was still located in the parking lot of [REDACTED]. Sergeant Peterson told me Matthews fired his gun multiple times at Canley and his vehicle, striking Canley in the chest area. Sergeant Peterson told me Canley was transported to Los Robles Hospital. Sergeant Peterson told me that a .45 caliber pistol was recovered from Canley's person.

I asked Sergeant Peterson if, to his knowledge, anyone had asked Detective Matthews the public safety questions. Sergeant Peterson told me, to his knowledge nobody had asked those questions yet.

I contacted Detective Matthews and had him brought near the crime scene tape barrier, outside the taped crime scene. I asked Detective Matthews how many shots he fired. Detective Matthews said he fired four shots. I asked him to generally show me where he was standing when he fired the shots and which direction he was shooting. Matthews showed me that he was standing near the entrance/exit of the parking lot, generally near the right front fender of where

13 DATE & TIME OF REPORT 11-16-06 / 1950	14 REPORTING OFFICER / ID NO. / DIV. / UNIT Sgt. M. Powers / #1365 / Special Services	15 APPROVED BY / ID NO. Det. S. Peterson #2238
---	--	---

NARRATIVE REPORT VENTURA COUNTY SHERIFF'S DEPARTMENT

Page 2 of 2 Continuation

AGENCY IDENTIFIER CA0560000

19072 9901 06-30402

4 CODE	5 ITEM	6 QTY.	7 ITEM NAME	8 BRAND / MAKE MANUFACTURER	9 MODEL NAME OR NUMBER	10 MISC DESCRIPTION	11 IDENTIFICATION / SERIAL NUMBER	12 VALUE
--------	--------	--------	-------------	-----------------------------	------------------------	---------------------	-----------------------------------	----------

Deputy Natoli's patrol vehicle was then parked. Detective Matthews showed me that generally he fired in a southerly direction toward the rear of the parking lot. Detective Matthews said as Canley's pick-up drove toward him, his direction of fire changed slightly from southerly to southeasterly, stopping near the small yellow and white house trailer on the east side of the parking lot. Detective Matthews said all of the rounds he fired hit Canley or the pick-up he was driving.

Detective Matthews did not speak about Canley firing a gun or seeing a gun displayed by Canley. As I knew that a pistol was found on Canley's person, I asked Detective Matthews if Canley had fired a gun at him. Detective Matthews told me Canley did not fire a gun at him, nor did he ever see Canley display a gun.

I asked Detective Matthews if there were any other (possibly injured) persons in the vehicle besides Canley that he saw. Detective Matthews said there weren't; Canley was the only occupant of the pick-up that he saw.

Pursuant to Department Policy, I directed (a supervisor) Senior Deputy Jeff Miller to take Detective Matthews to the nearest (East County) sub-station. Senior Deputy Miller took Detective Matthews to the East County Sheriff's Station.

I saw seven independent bullet holes in Canley's pick-up, five that appeared to have been fired from in front of his vehicle and two that appeared to have been fired at his vehicle from the rear. None of the bullet holes I saw in Canley's pick-up appeared to have exited the vehicle, other than a few fragments on the ground and one bullet that was on the driver's side of the vehicle on the ground.

I next checked the surrounding backdrop buildings of the shooting for victims and bullet holes, not finding victims or bullet holes in the buildings or vehicles to the backdrop of the shooting.

13 DATE / TIME OF REPORT 11-16-06 / 1950	14 REPORTING OFFICER / ID NO. / DIV / UNIT Sgt. M. Powers / #1365 / Special Services	15 APPROVED BY / ID NO. Det. S. Peterson #2238
---	---	---

NARRATIVE REPORT VENTURA COUNTY SHERIFF'S DEPARTMENT

Page 2 of 2 Continuation

AGENCY IDENTIFIER CA0560000

1 PD 9072	2 BEAT 9G01	3 RB NUMBER 06-30492
--------------	----------------	-------------------------

4 CODE	5 ITEM	6 QTY	7 ITEM NAME	8 BRAND / MAKE MANUFACTURER	9 MODEL NAME OR NUMBER	10 MISC. DESCRIPTION	11 IDENTIFICATION / SERIAL NUMBER	12 VALUE
--------	--------	-------	-------------	-----------------------------	------------------------	----------------------	-----------------------------------	----------

I entered the emergency room where medical staff was monitoring the suspect's vitals. Dep. Hawthorne #3384 removed a blanket exposing the suspect's chest and abdomen. I confirmed that the above listed tattoos matched that of the suspect.

I called [REDACTED] and obtained the following information:

Suspect : Adrian Doyle Canley



While at the hospital I was allowed access to one of their computers. I was able to access my department e-mail. [REDACTED] sent, via e-mail, Canley's DMV photo and latest Ventura County booking photo. I printed these photos and compared them with the suspect. Using the photos and the descriptions of the tattoos I positively identified the suspect as Adrian Canley.

I telephoned Sgt. O'Donnell and updated him regarding the positive ID. I also talked with Det. S. Peterson who was at the hospital conducting interviews with ambulance, fire and medical personnel. With Peterson's approval I gave the above suspect information to the hospital staff.

[REDACTED] also provided me with a criminal history for Canley. [REDACTED] told me Canley was currently on probation for 11550(a) H&S. [REDACTED] obtained all this information for department and state databases.

Refer to Dep. Hawthorne's report for additional information regarding the pronounced death of Canley.

I left the hospital at approx. 2100 hrs, and was not needed at the scene.

13 DATE / TIME OF REPORT 11/15/2006 7:22 AM	14 REPORTING OFFICER / ID NO. / UNIT Sr. Dep. D. Hawes #2261 / ECPS / SEU	15 APPROVED BY / ID NO. <i>[Signature]</i> 1351
--	--	--

NARRATIVE REPORT VENTURA COUNTY SHERIFF'S DEPARTMENT

Page 1 of 2 Continuation

AGENCY IDENTIFIER CA0560000

1 RD 9072	2 BEAT 9G01	3 RB NUMBER 2006-30492
--------------	----------------	---------------------------

4 CODE	5 ITEM	6 QTY.	7 ITEM NAME	8 BRAND / MAKE MANUFACTURER	9 MODEL NAME OR NUMBER	10 MISC. DESCRIPTION	11 IDENTIFICATION / SERIAL NUMBER	12 VALUE
--------	--------	--------	-------------	-----------------------------	------------------------	----------------------	-----------------------------------	----------

- Supplemental Case Cleared
 Gang Domestic Hate Child Abuse Elderly Abuse

Connecting Report Numbers:

Code Section / Description: Officer Involved Shooting

Reclassify To:

Code: P Name: Canley, Adrian Doyle

Identification of Party Adrian Canley

On November 14, 2006, at approximately 1925 hours, I arrived at the Los Robles Regional Medical Center Emergency Room, in the City of Thousand Oaks, to assist with this investigation. The party of this investigation, Adrian Canley, was receiving medical treatment for a gunshot wound to his right shoulder. At the time of my arrival, Adrian had yet to be positively identified.

At approximately 1945 hours, Senior Deputy Hawes #2261 arrived at the medical center. He advised me he was in the process of obtaining a positive identification of Adrian. I directed Senior Deputy Hawes to contact me once he had confirmed Adrian's identity.

At approximately 2015 hours, I was contacted by Senior Deputy Hawes who advised me he had positively identified Adrian. He provided me the following information concerning Adrian:



13 DATE / TIME OF REPORT 11/15/06/ 3:23 PM	14 REPORTING OFFICER / ID NO / DIV / UNIT Det. S. Peterson #2238 / Spl. Svcs. <i>SP</i>	15 APPROVED BY / ID NO <i>BA</i> Sgt. Ayub #3318
---	--	--

NARRATIVE REPORT VENTURA COUNTY SHERIFF'S DEPARTMENT

Page 2 of 2 Continuation

AGENCY IDENTIFIER CA0560000

1 PD 9072	2 BEAT 9G01	3 RB NUMBER 2006-30492
--------------	----------------	---------------------------

4 CODE	5 ITEM	6 QTY.	7 ITEM NAME	8 BRAND / MAKE MANUFACTURER	9 MODEL NAME OR NUMBER	10 MISC. DESCRIPTION	11 IDENTIFICATION / SERIAL NUMBER	12 VALUE
--------	--------	--------	-------------	-----------------------------	------------------------	----------------------	-----------------------------------	----------

in Oxnard." Senior Deputy Hawes also located a second address of [REDACTED]

Senior Deputy Hawes also provided me two black and white photographs of Adrian that I gave to Major Crimes Detective Sergeant Ayub #3318 on November 15, 2006.

At approximately 2025 hours, I called Major Crimes Detective Sergeant Powers #1365, who I knew was at the scene at [REDACTED] in the City of Thousand Oaks, on his cellular telephone. During that conversation, I advised him Adrian's information that Senior Deputy Hawes had provided me.

End of report.

13 DATE / TIME OF REPORT 11/15/06/ 3:23 PM	14 REPORTING OFFICER / ID NO / DIV / UNIT Det. S. Peterson #2238 / Spl. Svcs. <i>SP</i>	15 APPROVED BY / ID NO <i>JA</i> Sgt. Ayub #3318
---	--	--

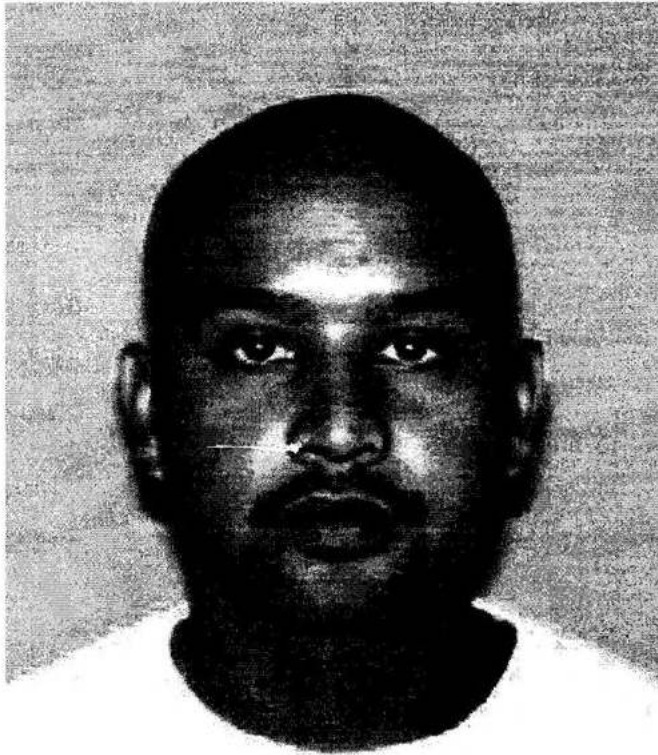

*SP 2238
11-14-06*

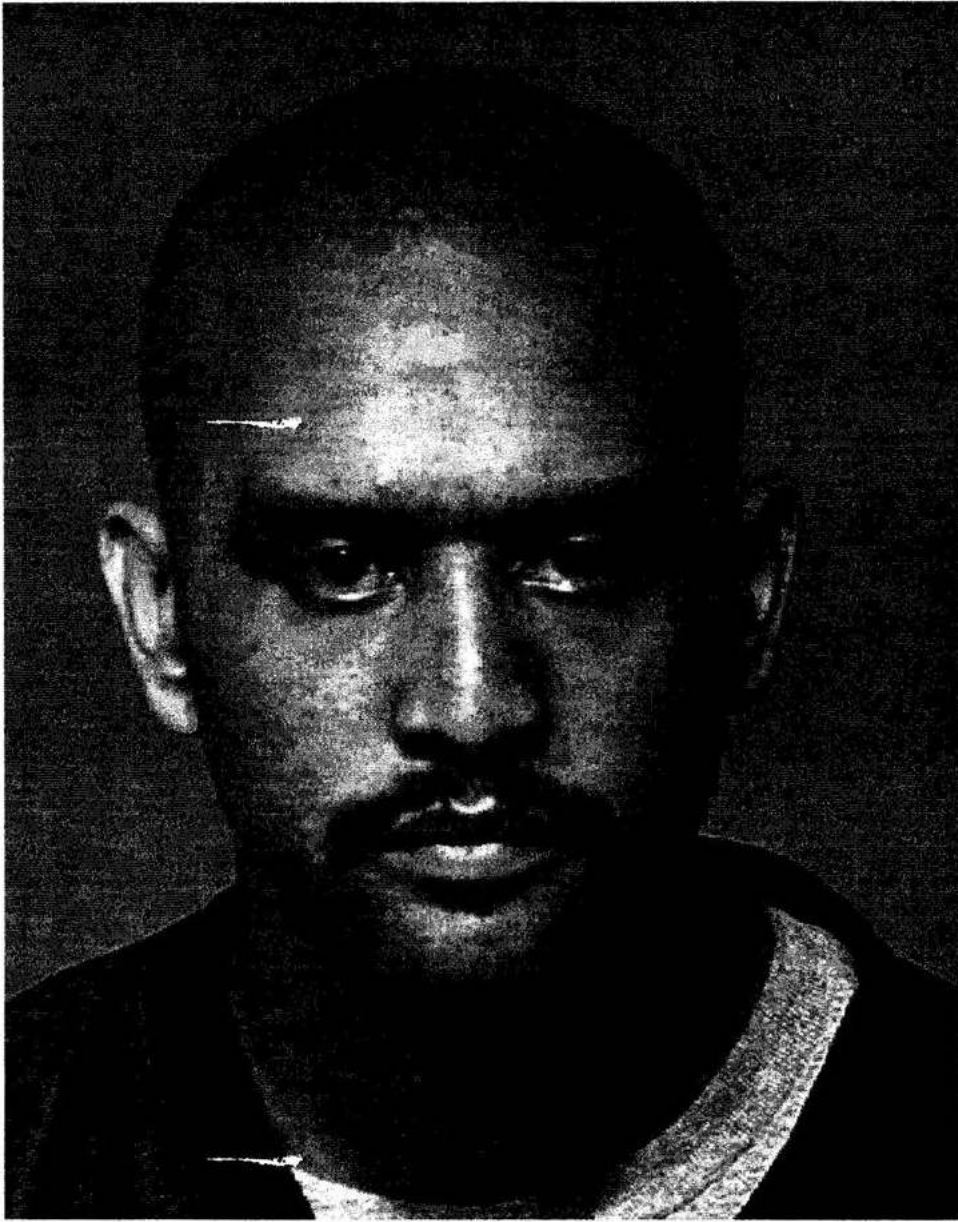

*AP 2738
11-14-06*

NARRATIVE REPORT VENTURA COUNTY SHERIFF'S DEPARTMENT

Page 1 of 2 Continuation

AGENCY IDENTIFIER CA0560000

1 RD 9072	2 BEAT 9G01	3 RB NUMBER 2006-30492
--------------	----------------	---------------------------

4 CODE	5 ITEM	6 QTY.	7 ITEM NAME	8 BRAND / MAKE MANUFACTURER	9 MODEL NAME OR NUMBER	10 MISC. DESCRIPTION	11 IDENTIFICATION / SERIAL NUMBER	12 VALUE
--------	--------	--------	-------------	-----------------------------	------------------------	----------------------	-----------------------------------	----------

- Supplemental** **Case Cleared**
- Gang** **Domestic** **Hate** **Child Abuse** **Elderly Abuse**

Connecting Report Numbers:

Code Section / Description: Officer Involved Shooting

Reclassify To:

Code: P **Name:** Canley, Adrian Doyle

Security and Transport of The Body of Adrian Canley

On November 14, 2006, at approximately 1925 hours, I arrived at the Los Robles Regional Medical Center Emergency Room, in the City of Thousand Oaks, to assist with this investigation. The party of this investigation, Adrian Canley, was receiving medical treatment for a gunshot wound to his right shoulder in Room 6 of the Emergency Room. Deputy Hawthorne #3384, a uniformed Patrol Deputy, was with Adrian as he received medical treatment. I directed him to remain with Adrian and not leave for any reason.

At 2013 hours, Doctor [REDACTED] declared Adrian deceased. Deputy Hawthorne continued to remain with Adrian's body in Room 6 of the Emergency Room.

At approximately 2052 hours, Senior Deputy Medical Examiner Stevens, from the Ventura County Medical Examiner's Office, arrived at the medical center to begin his investigation into this matter. Senior Deputy Medical Examiner Stevens and Deputy Hawthorne remained with Adrian's body in Room 6 of the Emergency Room while I continued my investigation.

At approximately 2215 hours, [REDACTED] (date of birth of [REDACTED]), employed by Cathedral Mortuary Associates, arrived at the medical center to transport Adrian's body to the Ventura County Medical Examiner's Office. After his arrival, he assisted Senior Deputy Medical

13. DATE / TIME OF REPORT 11/15/06/ 3:42 PM	14. REPORTING OFFICER / ID NO. / DIV / UNIT Det. S. Peterson #2238 / Spl. Svcs. <i>SP</i>	15. APPROVED BY / ID NO. Sgt. Ayub #3318 <i>SA</i>
--	--	---

NARRATIVE REPORT VENTURA COUNTY SHERIFF'S DEPARTMENT

Page 2 of 2 Continuation

AGENCY IDENTIFIER CA0560000

1 PD 9072	2 BEAT 9G01	3 RB NUMBER 2006-30492
--------------	----------------	---------------------------

4 CODE	5 ITEM	6 QTY.	7 ITEM NAME	8 BRAND / MAKE MANUFACTURER	9 MODEL NAME OR NUMBER	10 MISC. DESCRIPTION	11 IDENTIFICATION / SERIAL NUMBER	12 VALUE
--------	--------	--------	-------------	-----------------------------	------------------------	----------------------	-----------------------------------	----------

Examiner Stevens in placing Adrian's body into a body bag. Senior Deputy Medical Examiner Stevens secured the body bag with a body bag tag, number 49262. Field Evidence Technician Hayakawa #2963 and I both took digital images of the secured body bag and body bag tag with our department issued digital cameras.

At approximately 2230 hours [REDACTED] transported Adrian's body from the medical center to the Ventura County Medical Examiner's Office.

On November 15, 2006, I downloaded the digital images I took into the Digital Image Management System (DIMS).

End of report.

13 DATE / TIME OF REPORT 11/15/06/ 3:42 PM	14 REPORTING OFFICER / ID NO / DIV / UNIT Det. S. Peterson #2238 / Spl. Svcs. <i>SP</i>	15 APPROVED BY / ID NO <i>BA</i> Sgt. Ayub #3318
---	--	--

NARRATIVE REPORT VENTURA COUNTY SHERIFF'S DEPARTMENT

Page 1 of 2 Continuation

AGENCY IDENTIFIER CA0560000

1 RD 9072	2 BEAT 9G01	3 RB NUMBER 2006-30492
--------------	----------------	---------------------------

4 CODE	5 ITEM	6 QTY.	7 ITEM NAME	8 BRAND / MAKE MANUFACTURER	9 MODEL NAME OR NUMBER	10 MISC. DESCRIPTION	11 IDENTIFICATION / SERIAL NUMBER	12 VALUE
--------	--------	--------	-------------	-----------------------------	------------------------	----------------------	-----------------------------------	----------

Supplemental Case Cleared

Gang Domestic Hate Child Abuse Elderly Abuse

Connecting Report Numbers:

Code Section / Description: Officer Involved Shooting

Reclassify To:

Code: P **Name:** Canley, Adrian Doyle

Examination of The Body of Adrian Canley

On November 14, 2006, at approximately 1925 hours, I arrived at the Los Robles Regional Medical Center Emergency Room, in the City of Thousand Oaks, to assist with this investigation. The party of this investigation, Adrian Canley, was receiving medical treatment for a gunshot wound to his right shoulder in Room 6 of the Emergency Room. At 2013 hours, Doctor [REDACTED] declared Adrian deceased.

At approximately 2135 hours, I returned to Room 6 of the Emergency Room where Adrian's body was located. At that time, I conducted a visual examination of his body and took numerous digital images of him with my department issued digital camera. The following are my observations of Adrian's body and the trauma he received:

- Numerous tattoos covered Adrian's chest, shoulders, and abdominal area.
- A faint tattoo was on the back of Adrian's neck.
- An unknown type of medical apparatus was over Adrian's mouth and was held in place with a strap around his head. A tube was inserted into Adrian's mouth through the medical apparatus.
- A needle used to administer intravenous fluid was inserted into Adrian's right arm near the inside of his elbow.

13 DATE / TIME OF REPORT 11/15/06/ 3:21 PM	14 REPORTING OFFICER / ID NO / DIV / UNIT Det. S. Peterson #2238 / Spl. Svcs. <i>SP</i>	15 APPROVED BY / ID NO Sgt. Ayub #3318 <i>SA</i>
---	--	---

NARRATIVE REPORT VENTURA COUNTY SHERIFF'S DEPARTMENT

Page 2 of 2 Continuation

AGENCY IDENTIFIER CA0560000

1 RD 9072	2 BEAT 9G01	3 RB NUMBER 2006-30492
--------------	----------------	---------------------------

4 CODE	5 ITEM	6 QTY.	7 ITEM NAME	8 BRAND / MAKE MANUFACTURER	9 MODEL NAME OR NUMBER	10 MISC. DESCRIPTION	11 IDENTIFICATION / SERIAL NUMBER	12 VALUE
--------	--------	--------	-------------	-----------------------------	------------------------	----------------------	-----------------------------------	----------

- A gunshot wound entrance, covered by a bandage, was on Adrian's right shoulder. There was no exit wound on Adrian's back.
- There was an injury to Adrian's left thumb and forefinger.
- Numerous bruises were on Adrian's right bicep, forearm, and hand.
- Numerous bruises were on both of Adrian's thighs, knees, and calves.
- Numerous bruises were on Adrian's upper and lower back.

On November 15, 2006, I downloaded the digital images into the Digital Image Management System (DIMS).

End of report.

13 DATE / TIME OF REPORT 11/15/06/ 3:21 PM	14 REPORTING OFFICER / ID NO / DIV / UNIT Det. S. Peterson #2238 / Spl. Svcs. <i>SP</i>	15 APPROVED BY / ID NO Sgt. Ayub #3318 <i>BA</i>
---	--	---

NARRATIVE REPORT VENTURA COUNTY SHERIFF'S DEPARTMENT

Page 1 of 9 Continuation

AGENCY IDENTIFIER CA0560000

1 RD 9012	2 BEAT 9G	3 RB NUMBER 06-30492
--------------	--------------	-------------------------

4. CODE	5. ITEM	6. QTY.	7. ITEM NAME	8. BRAND / MAKE MANUFACTURER	9. MODEL NAME OR NUMBER	10. MISC. DESCRIPTION	11. IDENTIFICATION / SERIAL NUMBER	12. VALUE
---------	---------	---------	--------------	------------------------------	-------------------------	-----------------------	------------------------------------	-----------

BACKGROUND:

I was off duty at my residence when I received a call from Captain Convery. The Captain told me that there had been an officer involved shooting at [REDACTED] in Thousand Oaks. My presence was requested by the Major Crime Detectives to respond to the scene. I responded directly from my residence to the scene. Once at the scene I talked to Detective Ayub who briefed me on my assignment. My primary assignment was to measure and develop a crime scene map of the location including the vehicles at the location and the physical evidence pointed out by the detectives and lab personnel.

SCENE:

The incident occurred in the rear parking lot area of the residential complex at [REDACTED]. This parking lot has a single entry-exit driveway on its northwest corner. On the north side of the lot is a complex community room with a swimming pool. To the east side of the parking lot is a block wall that separates the parking lot and complex from adjoining property. On the south side of the parking lot is a two story living complex that contains units [REDACTED]. To the west side of parking lot there is a sidewalk and grass area next to the rear side of a carport building. The entry for these carports is on the west side of that building.

MEASUREMENTS:

The measurements depicted on the attached diagram and in the below listed legend are based on a Cartesian plane. The primary control point or the Origin for the diagram (0-0) is a point on the curb line on the west side of the parking lot, in the rear parking, lot at [REDACTED]. The curb line used is a north south curb line and the origin was place at approximately 25.9 feet south of where the curb lines starts. The origin was placed in line with a fracture joint in the concrete surface.

Control point 2 was in line with the same curb line prolongation and was 59.28 feet north of the Origin. The Y-axis is parallel with the west curb line of the parking lot.

13. DATE / TIME OF REPORT 11-13-06	14. REPORTING OFFICER / ID NO / DIV / UNIT RJ GODFREY 459 ECP 5	15. APPROVED BY / ID NO [Signature]
---------------------------------------	--	--

NARRATIVE REPORT VENTURA COUNTY SHERIFF'S DEPARTMENT

Page 2 of 9 Continuation

AGENCY IDENTIFIER CA0560000

1 RD 9072	2 BEAT 9601	3 RB NUMBER 06-30492
--------------	----------------	-------------------------

4 CODE	5 ITEM	6 QTY.	7 ITEM NAME	8 BRAND / MAKE MANUFACTURER	9 MODEL NAME OR NUMBER	10 MISC. DESCRIPTION	11 IDENTIFICATION / SERIAL NUMBER	12 VALUE
--------	--------	--------	-------------	-----------------------------	------------------------	----------------------	-----------------------------------	----------

The X-axis is perpendicular to the Y-axis. All the below listed measurements were rounded off to the nearest tenth of a foot except for CP2, which was rounded off to the hundredth of a foot.

	EAST ITEM WEST	NORTH+ SOUTH	ITEM DESCRIPTION
CP1	0.00	0.00	Origin
CP2	0.00	59.28'N	Control point 2
A	34.1'E	46.5'N	point of rest left rear wheel suspect vehicle
	40.2'E	56.6'N	point of rest left front wheel suspect vehicle
B	32.3.E	36.7'N	point of rest rear left front wheel - unit 3263
	23.9'E	41.3'N	point of rest left rear wheel patrol unit
C	54.4'E	26.2'N	point of rest right rear wheel of Chevrolet van
	63.6'E	26.2.N	point of rest right front wheel of Chevrolet van
D	56.4'E	10.1'N	point of rest right rear wheel Ford Mustang
	64.3'E	10.8'N	point of rest right front wheel Ford Mustang
E	64.2'E	16.5'S	point of rest small house trailer
	49.4'E	16.9'S	point of rest small house trailer
	46.9'E	20.8'S	point of rest small house trailer
	49.5'E	24.9'S	point of rest small house trailer
F	51.2'E	27.1'S	point of rest right front wheel Dodge truck
	51.2'E	33.5'S	point of rest left front wheel Dodge truck
G	52.9'E	36.1'S	point of rest right front wheel Dodge van
	53.2'E	42.1'S	point of rest left front wheel Dodge van
	62.3'E	42.1'S	point of rest left rear wheel Dodge van
H	13.0'E	43.9'S	point of rest right rear wheel Plymouth van
	3.9'E	44.6'S	point of rest right front wheel Plymouth van
J	12.2'E	36.6'S	point of rest right rear wheel Nissan Altima
	3.8'E	36.7'S	point of rest right front wheel Nissan Altima
K	13.6'E	28.1'S	point of rest right rear wheel Honda Accord

13 DATE / TIME OF REPORT 11-13-06	14 REPORTING OFFICER / ID NO / DIV / UNIT SA 455	15 APPROVED BY / ID NO [Signature] / 2486
--------------------------------------	---	--

NARRATIVE REPORT VENTURA COUNTY SHERIFF'S DEPARTMENT

Page 3 of 9

Continuation

AGENCY IDENTIFIER CA0560000

1 RD 9072	2 BEAT 9601	3 RB NUMBER 06-30492
--------------	----------------	-------------------------

4 CODE	5 ITEM	6 QTY.	7 ITEM NAME	8 BRAND / MAKE MANUFACTURER	9 MODEL NAME OR NUMBER	10 MISC. DESCRIPTION	11 IDENTIFICATION / SERIAL NUMBER	12 VALUE
--------	--------	--------	-------------	-----------------------------	------------------------	----------------------	-----------------------------------	----------

ITEM	EAST WEST	NORTH+ SOUTH	ITEM DESCRIPTION
	5.2'E	27.6'S	point of rest right front wheel Honda Accord
L	14.8'E	19.5'S	point of rest right rear wheel Ford Taurus
	6.0'E	19.5'S	point of rest right front wheel Ford Taurus
M	12.9'E	10.7'S	point of rest right rear wheel Toyota Corolla
	5.0'E	11.0'S	point of rest right front wheel Toyota Corolla
N	14.0'E	2.7'S	point of rest right rear wheel Chevrolet Cavalier
	5.5'E	2.9'S	point of rest right front wheel Chevrolet Cav.
P	12.5'E	17.8'S	point of rest left rear wheel Plymouth 4 door
	4.0'E	17.8'S	point of rest left front wheel Plymouth 4 door
	32.3'E	42.9'N	edge of fluid field
	29.2'E	38.4'N	edge of fluid field
	26.1'E	32.3'N	edge of fluid field
	24.1'E	28.5'N	edge of fluid field
	22.6'E	21.6'N	edge of fluid field
	24.6'E	21.0'N	edge of fluid field
	26.2'E	23.3'N	edge of fluid field
	26.4'E	26.6'N	edge of fluid field
	28.6'E	28.3'N	edge of fluid field
	28.6'E	31.4'N	edge of fluid field
	31.5'E	37.0'N	edge of fluid field
	34.1'E	41.7'N	edge of fluid field
	46.0'E	56.4'N	edge of fluid field
	44.2'E	58.1'N	edge of fluid field
	42.4'E	58.3'N	edge of fluid field
1	6.3'E	37.1'N	evidence tag 1
2	5.0'E	33.3'N	evidence tag 2
3	5.1'E	33.0'N	evidence tag 3
4	6.1'E	32.5'N	evidence tag 4

13 DATE / TIME OF REPORT 11-13-06	14 REPORTING OFFICER / ID NO / DIV / UNIT [Signature] 959	15 APPROVED BY / ID NO [Signature]
--------------------------------------	--	---------------------------------------

NARRATIVE REPORT VENTURA COUNTY SHERIFF'S DEPARTMENT

Page 4 of 9 Continuation

AGENCY IDENTIFIER CA0560000

1 RD 9072	2 BEAT 9601	3 RB NUMBER 06-30492
--------------	----------------	-------------------------

4 CODE	5 ITEM	6 QTY.	7 ITEM NAME	8 BRAND / MAKE MANUFACTURER	9 MODEL NAME OR NUMBER	10 MISC. DESCRIPTION	11 IDENTIFICATION / SERIAL NUMBER	12 VALUE
--------	--------	--------	-------------	-----------------------------	------------------------	----------------------	-----------------------------------	----------

	EAST ITEM WEST	NORTH+ SOUTH	ITEM DESCRIPTION
5	27.2'E	25.2'N	evidence tag 5
6	24.5'E	22.6'N	evidence tag 6
7	24.9'E	35.1'N	evidence tag 7
8	4.9'E	29.0'N	evidence tag 8
9	evidence tag 9 was at the center of two skid marks		
S1	15.4'E	5.7'N	start of right side acceleration mark
	18.4'E	5.7'N	end of above tire mark
S2	15.7'E	0.1'N	start of left side acceleration mark
	18.7'E	0.4'N	end of above tire mark
10	8.9'W	31.3'S	evidence tag 10
11	37.2'E	53.0'N	evidence tag 11
12	37.8'E	53.0'N	evidence tag 12
13	25.9'E	40.0'N	evidence tag 13
14	33.9'E	54.9'N	evidence tag 14
15	35.4'E	53.1'N	evidence tag 15 - edge of cloth
	26.0'E	40.1'N	edge of cloth
	34.3'E	52.5'N	edge of cloth
	35.6'E	52.5'N	edge of cloth
16	39.4'E	54.9'N	evidence tag 16 - edge of clothing field
	38.4'E	55.9'N	edge of clothing field
	39.7'E	57.4'N	edge of clothing field
	40.9'E	56.7'N	edge of clothing field

PHYSICAL EVIDENCE:

The following items of physical evidence were located at the scene of the collision. Additional details related to some of the items may be located in the Factual Diagram and Physical Evidence Diagram portions of this report

13 DATE / TIME OF REPORT 11-13-06	14 REPORTING OFFICER / ID NO / DIV / UNIT GPA-459	15 APPROVED BY / ID NO <i>[Signature]</i> 2486
--------------------------------------	--	---

NARRATIVE REPORT VENTURA COUNTY SHERIFF'S DEPARTMENT

1 RD 9072	2 BEAT 9601	3 RB NUMBER 06-30492
--------------	----------------	-------------------------

Page 5 of 9 ~~7~~ Continuation

AGENCY IDENTIFIER CA0560000

4 CODE	5 ITEM	6 QTY.	7 ITEM NAME	8 BRAND / MAKE MANUFACTURER	9 MODEL NAME OR NUMBER	10 MISC. DESCRIPTION	11 IDENTIFICATION / SERIAL NUMBER	12 VALUE
--------	--------	--------	-------------	-----------------------------	------------------------	----------------------	-----------------------------------	----------

TAG NUMBER	DESCRIPTION
1	cartridge case
2	cartridge case
3	cartridge case
4	cartridge case
5	copper fragment
6	lead fragment
7	copper fragment
8	cartridge case
9	two acceleration tire marks
10	notebook
11	lead and copper fragment
12	hand gun
13	cell phone
14	gloves
15	shorts (underwear)
16	several items of clothing

OTHER INFORMATION:

At the scene of the incident were two acceleration scuffmarks. These marks were very fresh with tire material visible within each of the marks. Each of the marks was approximately 3 feet long and appeared to have been created by a vehicle traveling in an eastbound direction. When measured, the exterior of the marks was within one half of an inch from the exterior wheelbase of the rear tires of the vehicle the suspect was driving. (Vehicle A)

13 DATE / TIME OF REPORT 11-13-06	14 REPORTING OFFICER / ID NO / DIV / UNIT G.A. 459	15 APPROVED BY / ID NO <i>[Signature]</i>
--------------------------------------	---	--

NARRATIVE REPORT VENTURA COUNTY SHERIFF'S DEPARTMENT

Page 6 of 9 Continuation

AGENCY IDENTIFIER CA0560000

1 RD 9072	2 BEAT 9601	3 RB NUMBER 06-30492
--------------	----------------	-------------------------

4 CODE	5 ITEM	6 QTY	7 ITEM NAME	8 BRAND / MAKE MANUFACTURER	9 MODEL NAME OR NUMBER	10 MISC. DESCRIPTION	11 IDENTIFICATION / SERIAL NUMBER	12 VALUE
--------	--------	-------	-------------	-----------------------------	------------------------	----------------------	-----------------------------------	----------

VEHICLE INFORMATION:

VEHICLE A:

1999, Ford, F150, pickup truck, white, California license number [REDACTED]
 Registered Owner: Adrian D Canley, [REDACTED]

VEHICLE B:

2003, Ford, police patrol car, black and white, California license number 1160234
 Exempt Unit number 3263
 Registered Owner: County of Ventura GSA Fleet Svc. 664 El Rio Dr. Oxnard, Ca.

VEHICLE C:

Unk, Chevrolet, Astro, Van, maroon, California license number [REDACTED]
 Registered Owner: no record on file

VEHICLE D:

1989, Ford, Mustang, black, California license number [REDACTED]
 Registered Owner: [REDACTED]

VEHICLE E:

Unk, Prowler, travel trailer, white and yellow, no license plate or VIN attached
 California Consumer Affaires number [REDACTED]
 Registered Owner: no record on file

VEHICLE F:

2004, Dodge, pickup truck, white, Ram, California license number [REDACTED]
 Registered Owner: [REDACTED]

13 DATE / TIME OF REPORT 11-13-06	14 REPORTING OFFICER / ID NO / DIV / UNIT [Signature] 459	15 APPROVED BY / ID NO [Signature]
--------------------------------------	--	---------------------------------------

NARRATIVE REPORT VENTURA COUNTY SHERIFF'S DEPARTMENT

1 RD 9072	2 BEAT 9601	3 RR NUMBER 06-30492
--------------	----------------	-------------------------

Page 7 of 9 Continuation

AGENCY IDENTIFIER CA0560000

4 CODE	5 ITEM	6 QTY	7 ITEM NAME	8 BRAND / MAKE MANUFACTURER	9 MODEL NAME OR NUMBER	10 MISC DESCRIPTION	11 IDENTIFICATION / SERIAL NUMBER	12 VALUE
--------	--------	-------	-------------	-----------------------------	------------------------	---------------------	-----------------------------------	----------

VEHICLE G:

1991, Plymouth, Voyager, van, silver, California license number [REDACTED]

Registered Owner: [REDACTED]

[REDACTED] thousand Oaks, Ca.

VEHICLE H:

1998, Plymouth, Voyager, van, white, California license number [REDACTED]

Registered Owner: [REDACTED]

Ca.

VEHICLE J:

1995, Nissan, Altima, 4 door, burgundy, California license number [REDACTED]

Registered Owner: [REDACTED]

VEHICLE K:

1994, Honda, Accord, 4 door, white, California license number [REDACTED]

Registered Owner: [REDACTED]

VEHICLE L:

1990, Ford, Taurus, 4 door, gray, California license number [REDACTED]

Registered Owner: [REDACTED]

Thousand Oaks, Ca.

VEHICLE M:

1993 Toyota, Corolla, 4 door, dark green, California license number [REDACTED]

Registered Owner: [REDACTED]

13 DATE / TIME OF REPORT 11-13-06	14 REPORTING OFFICER / ID NO / DIV / UNIT [Signature] 109	15 APPROVED BY / ID NO [Signature]
--------------------------------------	--	---------------------------------------

NARRATIVE REPORT VENTURA COUNTY SHERIFF'S DEPARTMENT

Page 8 of 9 ~~Continuation~~

AGENCY IDENTIFIER CA0560000

1 RD 9072	2 BEAT 9601	3 RB NUMBER 06-30492
--------------	----------------	-------------------------

4 CODE	5 ITEM	6 QTY	7 ITEM NAME	8 BRAND / MAKE MANUFACTURER	9 MODEL NAME OR NUMBER	10 MISC DESCRIPTION	11 IDENTIFICATION / SERIAL NUMBER	12 VALUE
--------	--------	-------	-------------	-----------------------------	------------------------	---------------------	-----------------------------------	----------

VEHICLE N:

1997, Chevrolet, Cavalier, 4 door, blue, California license number [REDACTED]

Registered Owner: [REDACTED]

[REDACTED] Thousand Oaks, CA

VEHICLE P:

1992, Plymouth, 4 door, white, California license number [REDACTED]

Registered Owner: [REDACTED]

13 DATE / TIME OF REPORT 11-13-06	14 REPORTING OFFICER / ID NO / DIV / UNIT [Signature] 459	15 APPROVED BY / ID NO [Signature] 1086
--------------------------------------	--	--

NARRATIVE REPORT VENTURA COUNTY SHERIFF'S DEPARTMENT

Page 9 of 9 *Y* Continuation

AGENCY IDENTIFIER CA0560000

1 RD 9072	2 BEAT 9601	3 RB NUMBER 06-30492
---------------------	-----------------------	--------------------------------

4 CODE	5 ITEM	6 QTY.	7 ITEM NAME	8 BRAND / MAKE MANUFACTURER	9 MODEL NAME OR NUMBER	10 MISC. DESCRIPTION	11 IDENTIFICATION / SERIAL NUMBER	12 VALUE
--------	--------	--------	-------------	-----------------------------	------------------------	----------------------	-----------------------------------	----------

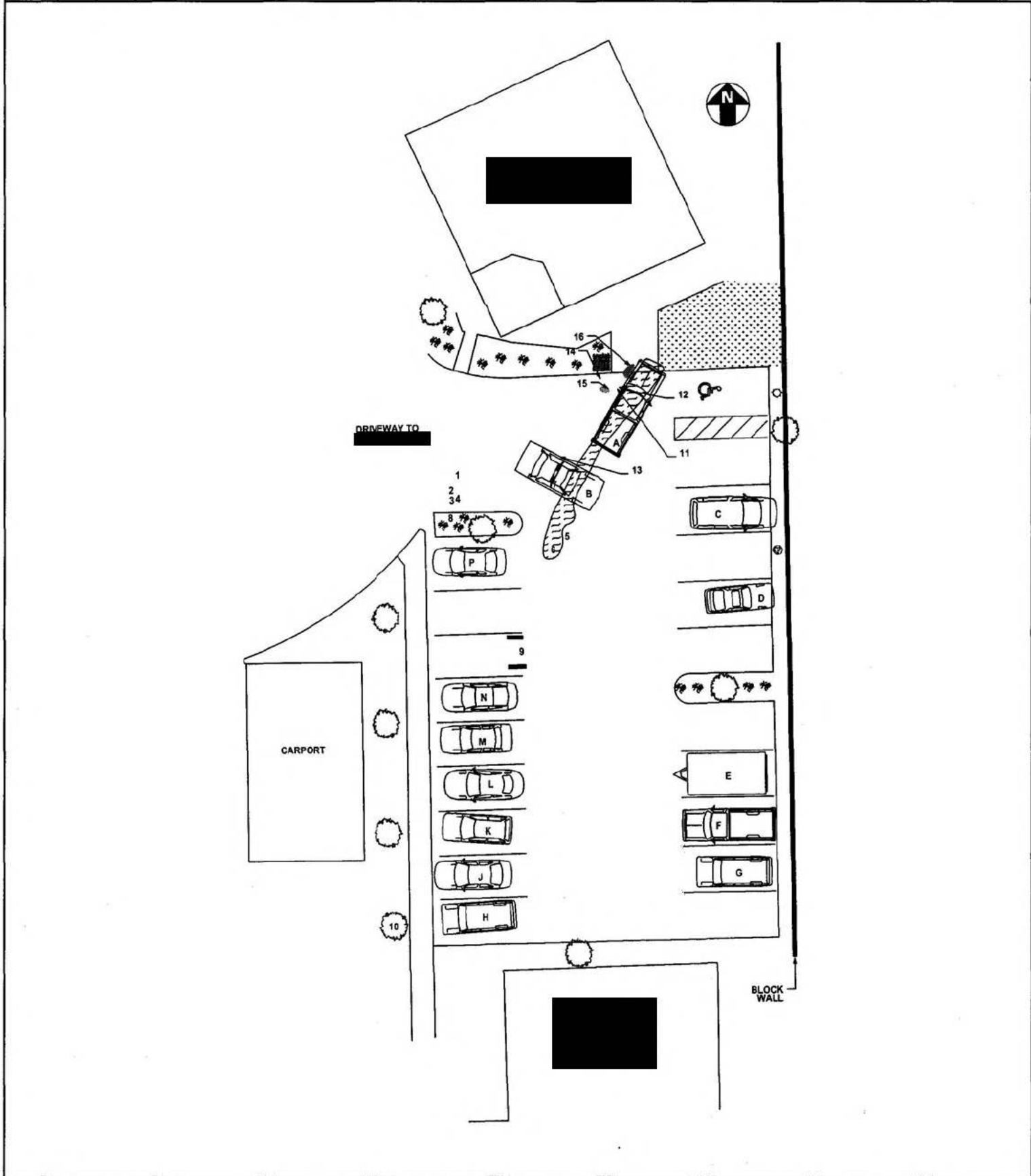

13 DATE / TIME OF REPORT 11-13-06	14 REPORTING OFFICER / ID NO. / DIV / UNIT <i>[Signature]</i> 459	15 APPROVED BY / ID NO. <i>[Signature]</i>
---	--	---

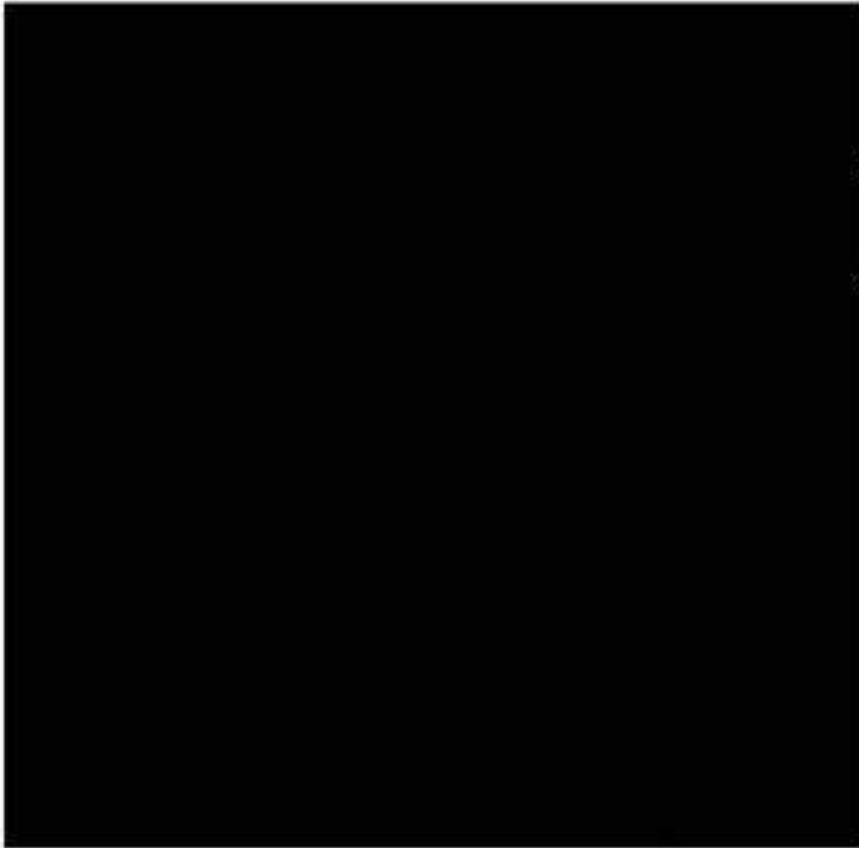

C:56

4

END



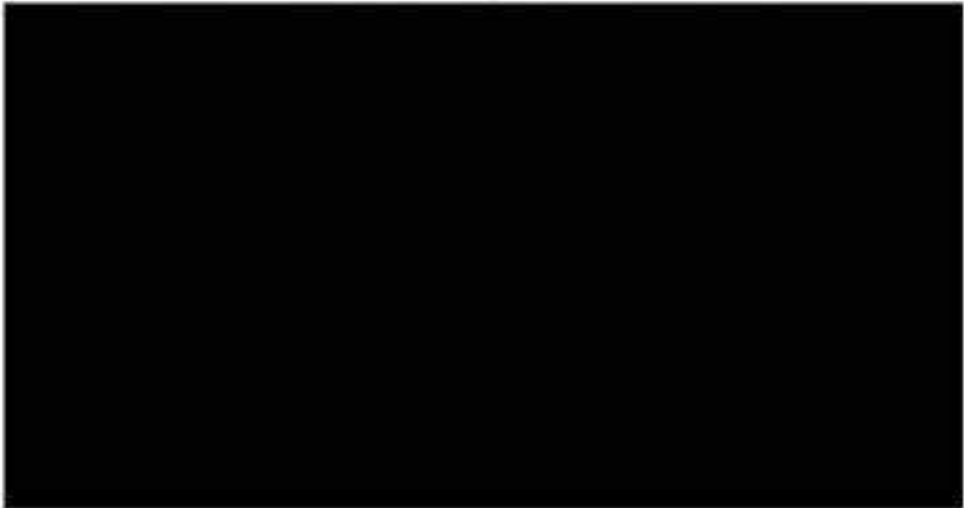

END





END



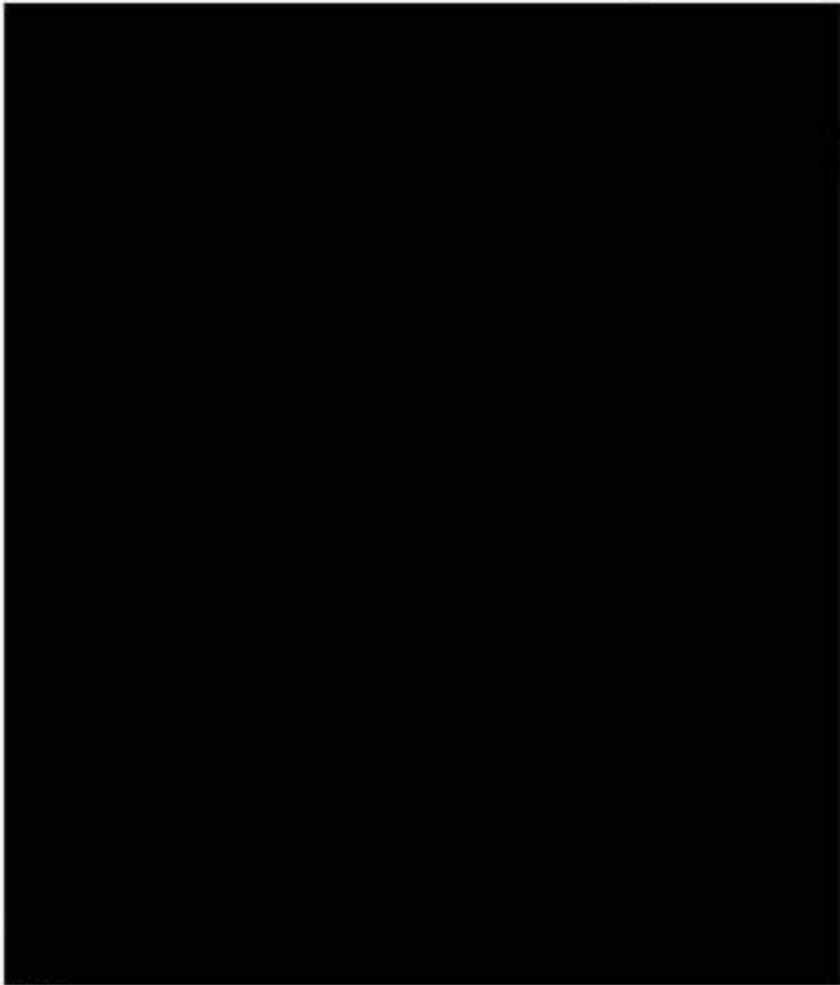

8
56

END



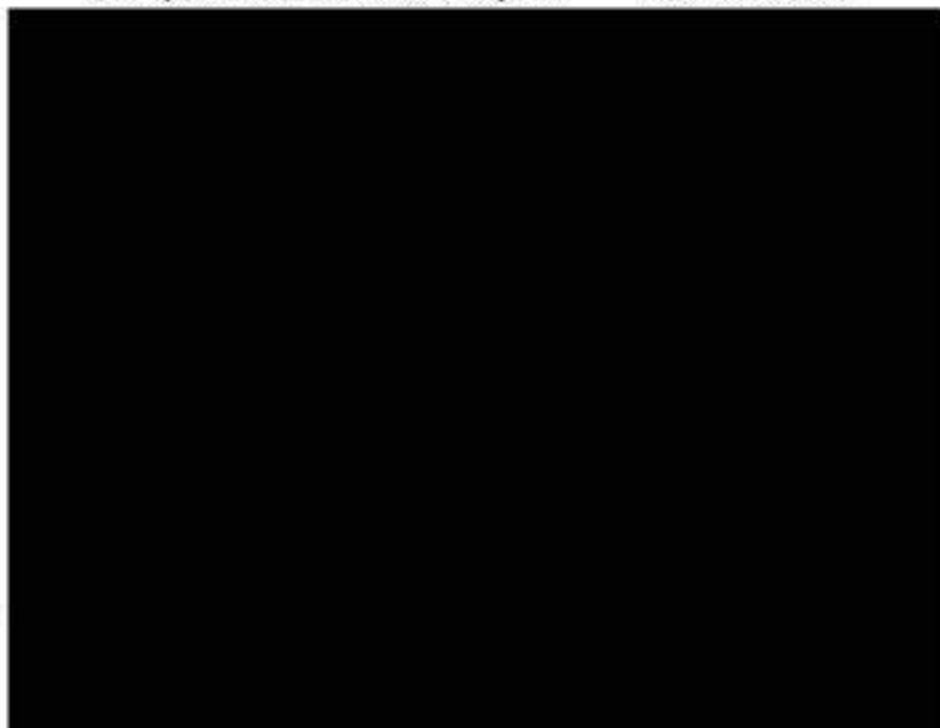

END



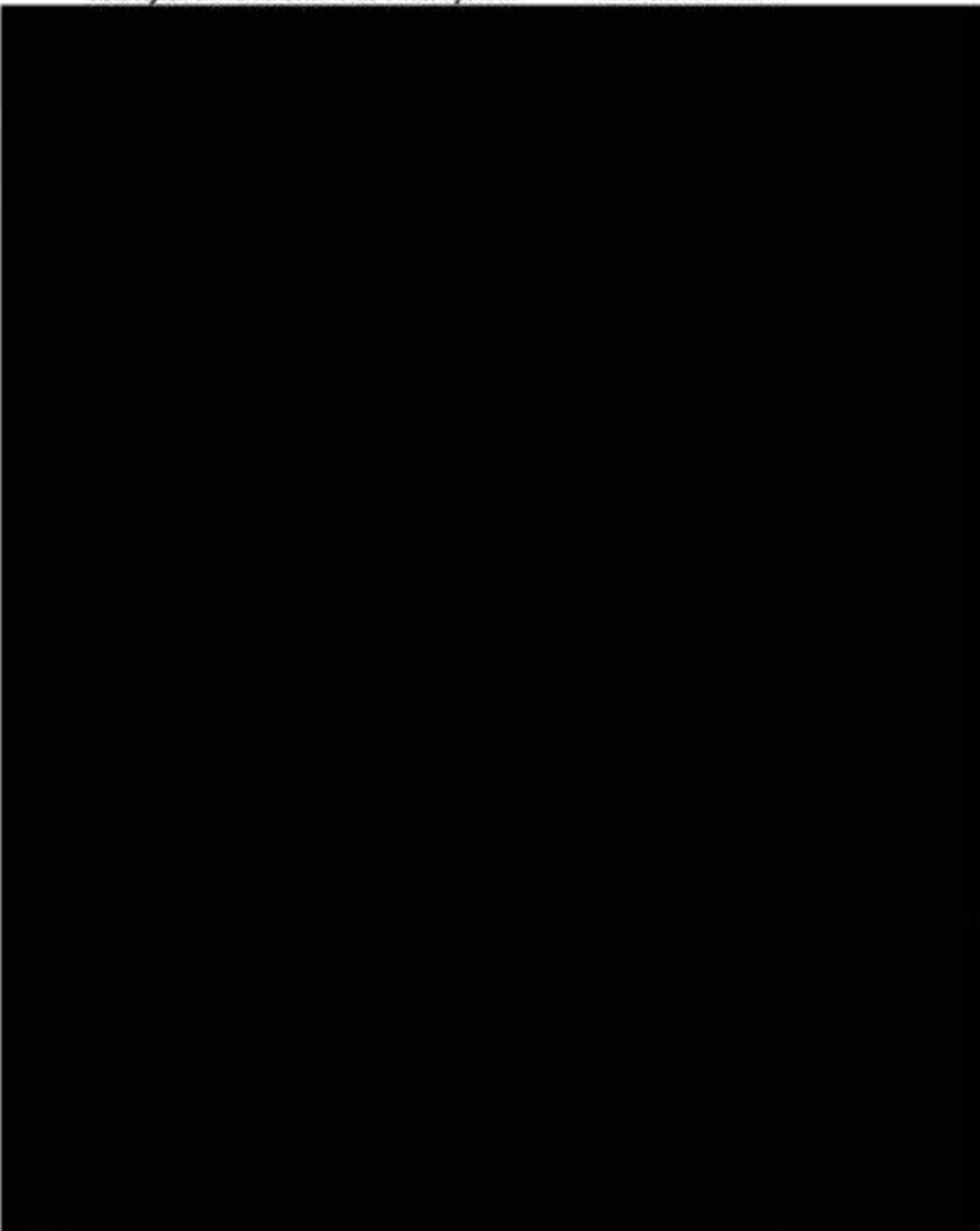

END





END



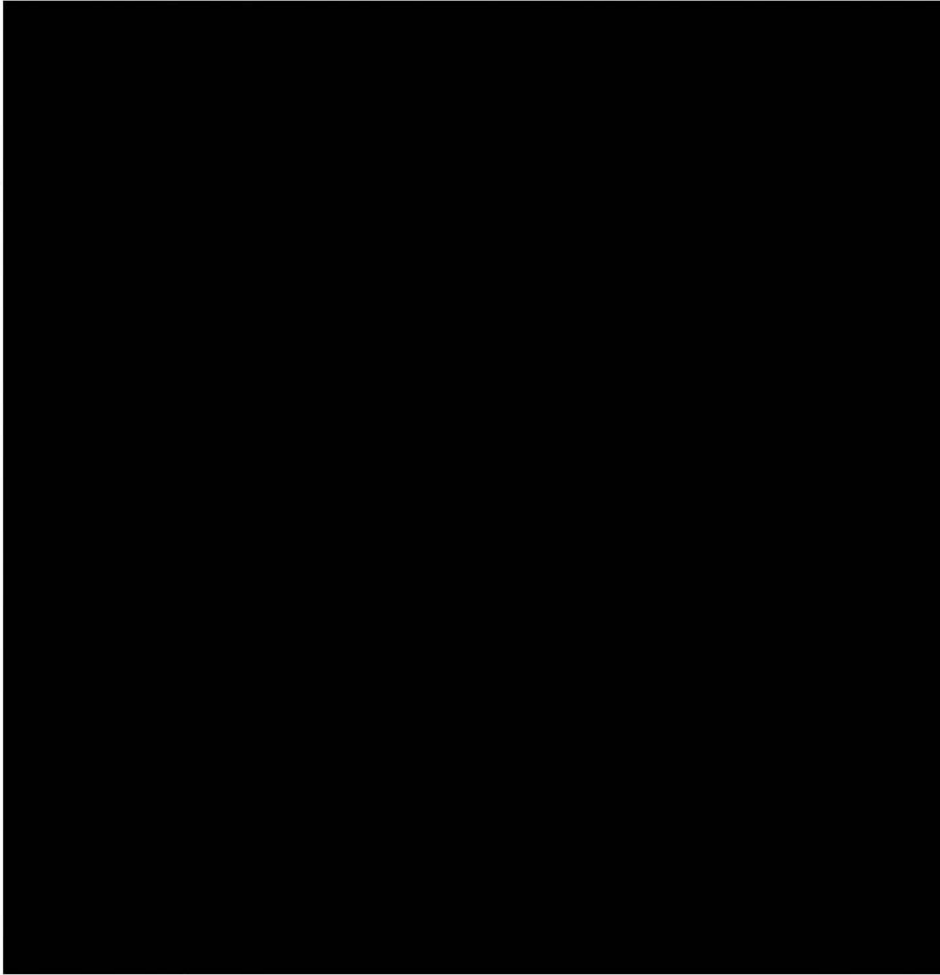

END



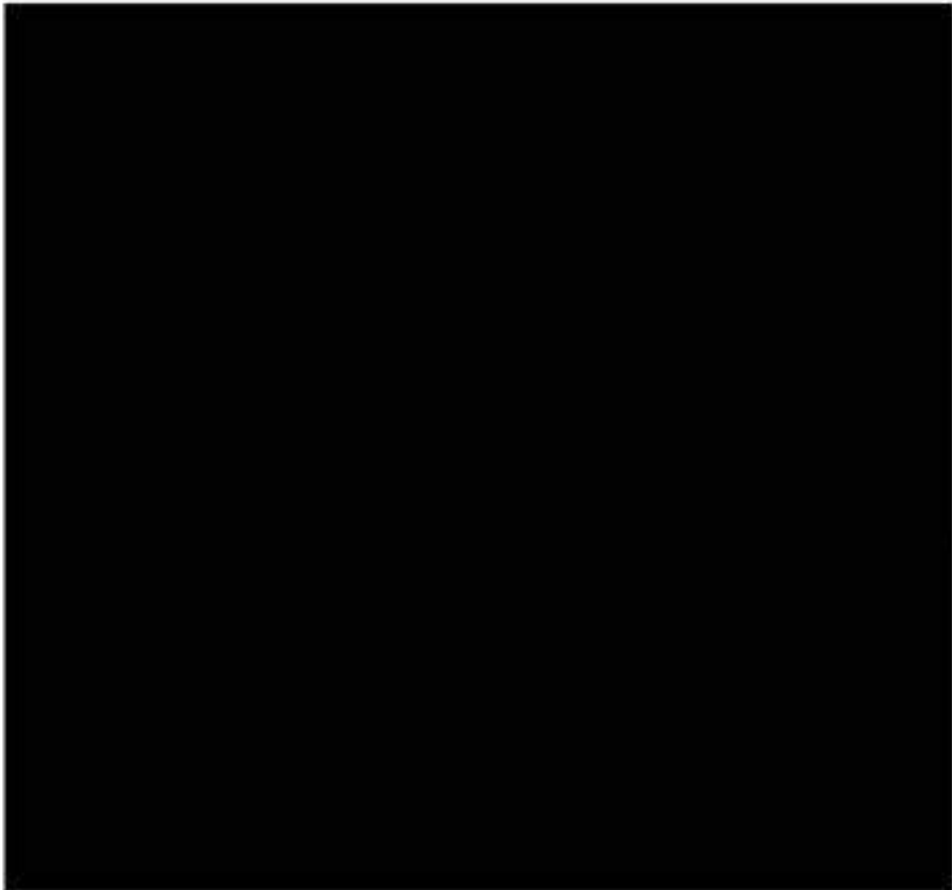

END



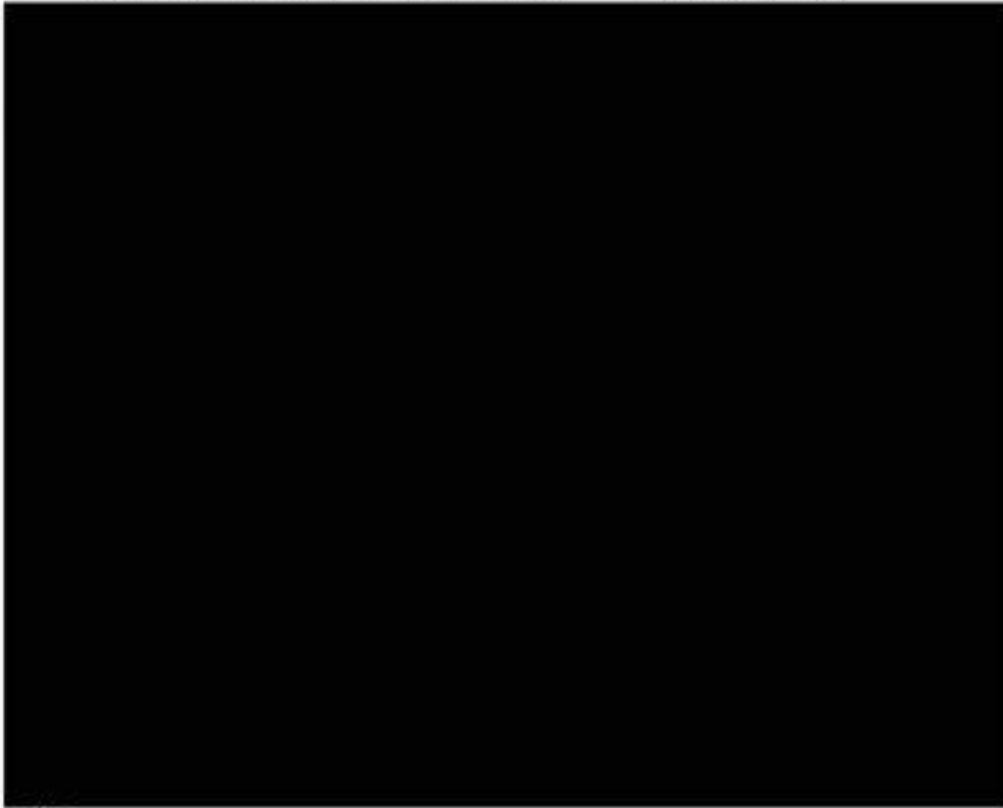

END





END



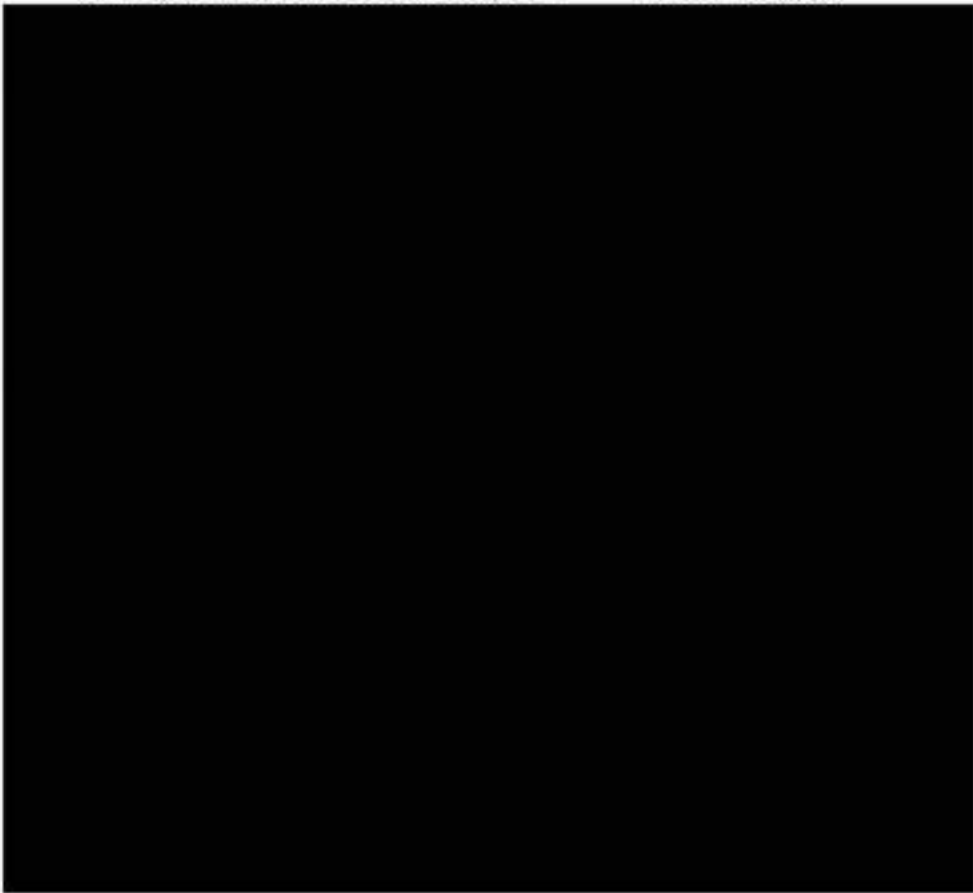

END



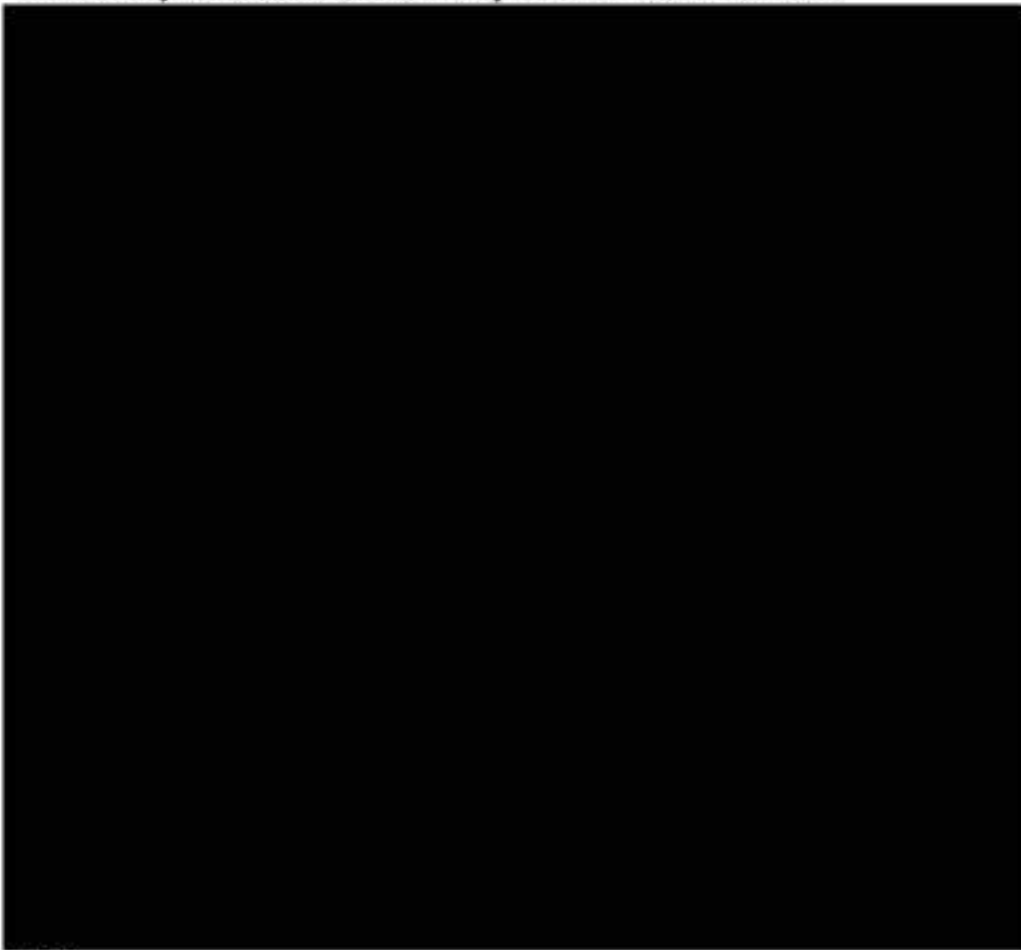

END



VENTURA COUNTY SHERIFF'S DEPARTMENT
 AGENCY IDENTIFIER CA05600

ICS ATTACHMENTS <input type="checkbox"/> MAP SKETCH <input type="checkbox"/> ORGANIZATION CHART	R.D.	BEAT	CASE NUMBER
<input type="checkbox"/> RESOURCES SUMMARY <input type="checkbox"/> ACTIVITY SUMMARY	9072	99	06-30492

LEICS REPORT

INCIDENT NAME OFFICER INVOLVED SHOOTING	DATE 11/14/06	TIME PERIOD 1820
--	------------------	---------------------

CURRENT SITUATION

WHAT ADW ON PEACE OFFICER

WHEN 1820 HRS

WHERE [REDACTED]

VICT MATTHEWS, SHANE

SUSP CANLEY, ADRIAN DOYLE

SUSP _____

VEH [REDACTED] FORD F150

HOW _____

WHY/OTHER (S) TRIED TO RUN DOWN DETECTIVE

ACTIONS / OBJECTIVES (Mark box / enter time when completed)

<input type="checkbox"/> _____ STABILZE / SECURE SCENE	<input type="checkbox"/> _____ ADDITIONAL RESOURCES (Copter, K-9)
<input type="checkbox"/> _____ MEDICAL AID	<input type="checkbox"/> _____ EVACUATION
<input checked="" type="checkbox"/> <u>1830</u> INNER PERIMETER	<input type="checkbox"/> _____ BROADCAST PREPARED / DISPATCHED
<input checked="" type="checkbox"/> <u>1900</u> OUTER PERIMETER	<input type="checkbox"/> _____ SAFETY / HAZARD CONSIDERATIONS
<input type="checkbox"/> _____ VICTIM / SUSPECT SEARCH	<input type="checkbox"/> _____ DEBRIEFING
<input checked="" type="checkbox"/> <u>1900</u> COMMAND POST	<input type="checkbox"/> _____
<input type="checkbox"/> _____ ICS GROUPS	<input type="checkbox"/> _____
<input type="checkbox"/> _____ TRAFFIC CONTROL	<input type="checkbox"/> _____
<input type="checkbox"/> _____ BRIEF PERSONNEL	<input type="checkbox"/> _____

OUTCOME (S) 10-7 LOS ROBLES FR.

ICS 201	PREPARED BY	DATE/TIME	APPROVED BY
PAGE 1 OF 1	C. PETERSON 2784	11-14-06/2030	<i>[Signature]</i>

VENTURA COUNTY SHERIFF'S DEPARTMENT
AGENCY IDENTIFIER CA05600

INCIDENT NAME OFFICER-INVOLVED SHOOTING	CURRENT ORGANIZATION	R.D. 9072	BEAT 99	CASE NUMBER 06-30492
--	----------------------	--------------	------------	-------------------------

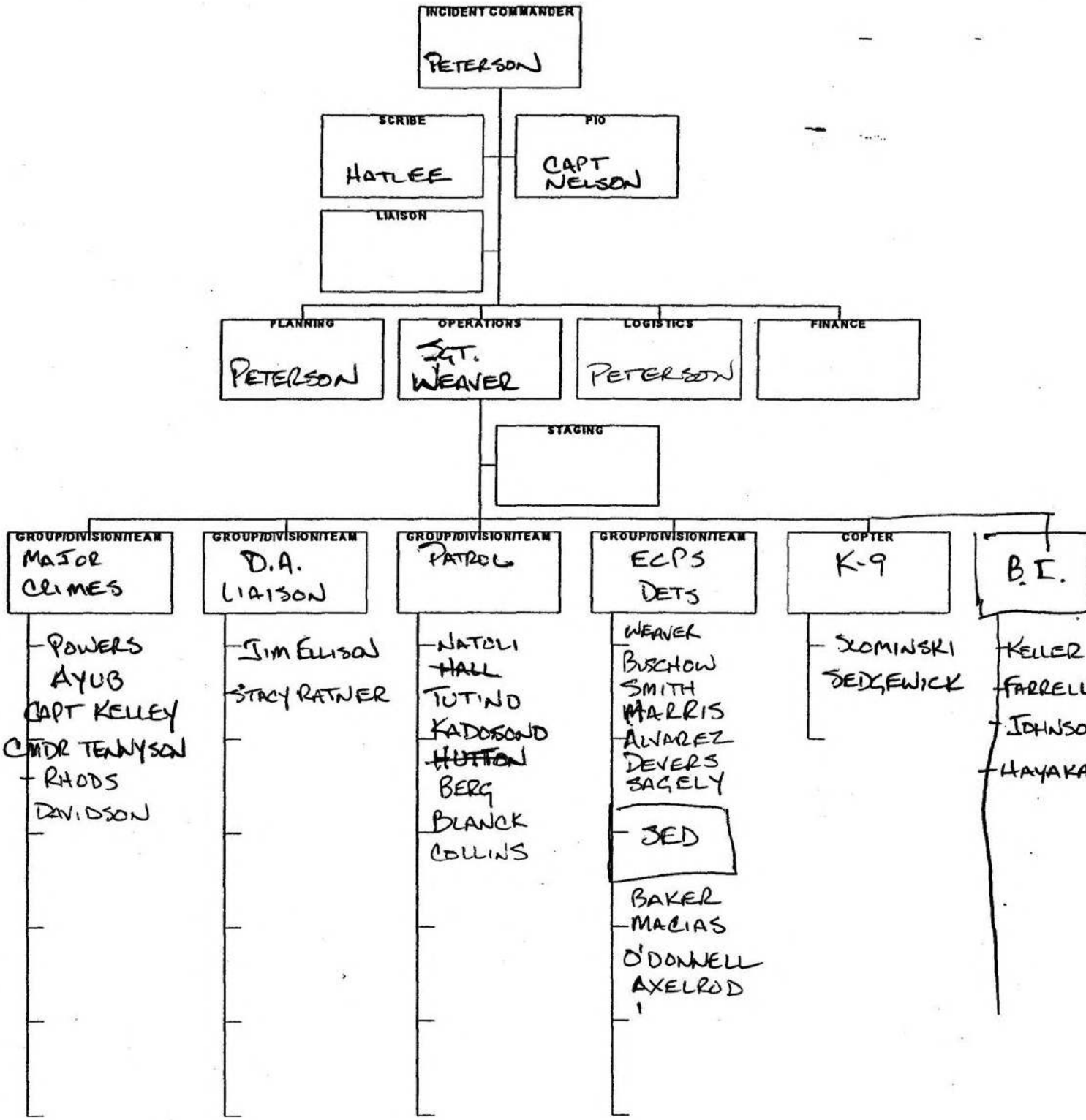

GROUP/DIVISION/TEAM CAN BE: TRAFFIC, SECURITY, INVESTIGATIONS, EVACUATION, CROWD CONTROL, ETC.

ICS 201a PAGE ___ of ___	PREPARED BY C. PETERSON 2784	DATE/TIME 11-14-06/2030	APPROVED BY [Signature]
-----------------------------	---------------------------------	----------------------------	----------------------------

I. A.

- INGLIS
- MURRAY

VENTURA COUNTY SHERIFF'S DEPARTMENT
 AGENCY IDENTIFIED CA05600

CRIME SCENE ENTRY LOG

PAGE 1 OF 1

ORIGINAL INCIDENT/OFFENSE 06-30492		DATE/TIME OF INCIDENT 11-14-06/2000	LOCATION OF INCIDENT 2222 LOS FEIZ	
INNER PERIMETER CRIME SCENE				
TIME IN	TIME OUT	NAME/I.D.	ASSIGNMENT	REASON
2000	0130	SGT POWERS	MAJOR CRIMES	
2000	0150	SGT AYUB	MAJOR CRIMES	
2000	0150	SR DEP DAUGHTON	MAJOR CRIMES	
2010	2320	DEP MAYO	EAST PATROL	
UNKNOWN	0030	DEP BERG	EAST PATROL	
2011	2015	SR DEP GODFREY	EAST COUNTY TRAFFIC	
2020	0121	DEP NADLE	EAST COUNTY TRAFFIC	CRIME SCENE PROTECTION
2020	2345 2018	SR DEP GODFREY		CRIME SCENE INVEST
2015	0155	SST [REDACTED]	CRIME SCENE INVESTIGATION	
2040	2115	CAPT. KELLEY	MAJOR CRIMES	
2054	2130	D.A. RATTNER		
2054	2130	D.A. DAN THOMPSON INVESTIGATOR	D.A. INVESTIGATOR	
2054	2130	D.A. STEAMAN	D.A. INVESTIGATOR	
2103	0155	SR DEP KELLER	CRIME SCENE	
2115	2345	SS.T [REDACTED]	EAST TRAFFIC	CRIME SCENE INVEST
2130	2305	SGT. RHODIES		
2320	0100	KADSONO, DEP	EAST PATROL	CRIME SCENE PERIMETER
0003	0040	SR DEP MATTHEWS	EAST PATROL	WALK THRU
0003	0040	SGT INGLIS	INTERNAL AFFAIRS	WALK THRU
0003	0040	SGT MURRAY	INTERNAL AFFAIRS	WALK THRU
0003	0040	RECK SHIMMEL, D.A.	VC DSA INTERNAL AFFAIRS	WALK THRU
0003	0040	DA. THOMPSON		WALK THRU
0003	0040	D.A. RATTNER		WALK THRU
0003	0040	D.A. STEAMON		WALK THRU
0003	0040	BILL HADDEN	LAWYER	WALK THRU

VENTURA COUNTY SHERIFF'S DEPARTMENT

CRIME SCENE ENTRY LOG

AGENCY IDENTIFIED CA05600

PAGE / OF 3

ORIGINAL INCIDENT/OFFENSE		DATE/TIME OF INCIDENT		LOCATION OF INCIDENT	
OFC. INVOLVED SUBJECT ADJ. & POLICE OFC.		11/14/04 1820		2222 LOS FELIZ	
C.P. CHECK-IN LOG					
TIME	NAME/I.D.		ASSIGNMENT		REASON
1830	0823	NATOLI 3421	9T3		MARK EVIDENCE
}	1905	HALL 3472	9M6		}
	2340	BERG 1929	9J51		
	2145	AXELROD 3114	SED		
	1845	[REDACTED]	FIRE STA 31		
}	1845		AMR 99-429		}
			AMR 99-429		
1840	0835	DET. HARRIS 3713	E.C. DET		MARK EVIDENCE
1900		SGT. POWERS	MGR. CRIME		
1915	2310	" RHODS	" "		
1900	0030	CAPT PONTIS 1927	E.C. PAT CAPT		
1900	2145	SGT. WERNER 1276	E.C. DET.		OPERATIONS MGR.
1915	2145	SGT. DONNELL 1554	E.C. SED		
1915	2040	Jim ELLISON	D.A.'S OFFICE		
1840	2140	NACIAS 2561	E.C. SED		CANVAS
1840	2145	BUSCHOW 2552	E.C. DET		INTERVIEW WITNESS
1845	2335	ALVAREZ LUIS	E.C. DET		
1910	0010	CMOR. CARPENTER 1006	E.C. CMDR		

ORIGINAL INCIDENT/OFFENSE		DATE/TIME OF INCIDENT		LOCATION OF INCIDENT	
		11/14/06 1820		2222 LOS FELIZ	
C.P. CHECK-IN LOG					
TIME		NAME/I.D.		ASSIGNMENT	REASON
1830	2210	FELRUZZA 3045		9041	PERIMETER
1850	2210	SMITH, JON 2569		E.C. DET	CANVAS
1905	2035	SLIMINSKI 3424		CLERK 3046 3BK	PERIMETER
1905	1945	SEBOWICZ 3046		3 BK	PERIMETER
1925	2105	CAPT. TENNESSEN 1186		MSR. CRIMES	
1927	2145	BLANCK 3155		9021	CANVAS
1840	0135	PETERSEN 2784		454	I.C.
1930		CPT. O'HANLON 1448		I.A.	
1930	0135	CPT. NELSON 2074		P.I.O.	
1930	0135	SEN AYUB 3318		MSR. CRIMES	
1930	0135	KADOSNO 3628		9B21	CANVAS
1935	0135	FARRELL 3322		CRIME SCENE INV. B.I.	
1935	2105	CHIEF DEAN		PATROLMAN CHIEF	
1913	2145	SAGELEY 2486		E.C. DET	CANVAS
1830	2345	HATLEE 2507		4E12	SERIBE
1940	2140	HUTTEN 3438		9621	CANVAS DEEP RECONSTRUCTION TO HERRA
1945	0135	UNDER MITCH THAKTEN, ERIC CAMERON, DAN		FINDS STA 37	LIGHTING
1905	2320	DELOS SANTOS 0730		E.C. ADMIN	
1950	2345	CAPT. KELLEY 1822		MSR. CRIMES	
2000	0135	KELLER 1630		B.I.	B.I.
1845	0135	TUTINO 3273		9D21	INNER PERIMETER
2010	2140	BAKER, BRIAN 3152		9X6 S6D	CANVAS
2012	0115	STEAMAN, LANCE 154		D.A. INVESTIGATOR	
2015	2345	GODFREY, RICK 0459		9T	CRIME SCENE RECONSTRUCTION
2015	2040	JOHNSON, BILL 3426		C.S.I.U.	

VENTURA COUNTY SHERIFF'S DEPARTMENT
 AGENCY IDENTIFIED CA05600

CRIME SCENE ENTRY LOG

PAGE 3 OF 3

ORIGINAL INCIDENT/OFFENSE		DATE/TIME OF INCIDENT	LOCATION OF INCIDENT	
TIME	C.P. CHECK-IN LOG		REASON	
	NAME/ I.D.	ASSIGNMENT		
2015	2040	HAYAKAWA, BRUC ²⁹⁶³	C.S. I.U.	
2020	2315	THOMPSON, DAN ¹⁵³	D.A. INVEST	
2030	0115	RATNER, STACY	D.A. OFFICE	
2000	2145	DEVERS, ALLEN ²¹⁷²	E.C. DET	CANVAS
2035	2052	INGUS, TODD ²⁶⁹¹	I.A.	
2035	2052	MURRAY, DAVID ²⁷²¹	I.A.	
1850	2000	DAVIDSON, ROB	MJR CRIME	
1900	2140	COLLINS 329	9611	CANVAS
1825	0015	ERAMBUNGH 2651	9251	OUTER PERIMETER
1914	2325	MAYO 2883	9B11	INNER PERIMETER
2015	0045	KEIGHTON, BRIAN SP3	ALAN WISOTSKY OFFICE	
2110	2348	RAUTIOKA ²⁷⁴⁰ GTR	91R	ASSIST QT
2135	2150	MITNICK, SCOTT	CITY MGR	ASSIST EMDR. ^{CANV}
1935	2215	JONES, CHRIS	9051	PERIMETER
2240	2320	PETERSON, SCOTT ²²³⁸	MJR CRIMES	
2325	2345	THOMPSON, DAN	D.A. INVEST	
2114	0135	MORRIS 1768	E.C. ADMIN	COMMAND POST
2355	0135	DAVIDSON		
2355	0047	MURPHY		
2355	0046	INGLET		
0015	0135	JONES		
	0135	CRIME SCIENCE SHUT DOWN		0135 HRS

NARRATIVE REPORT VENTURA COUNTY SHERIFF'S DEPARTMENT

Page 1 of 10

Continuation

AGENCY IDENTIFIER CA0560000

1 RD 9072	2 BEAT 9G01	3 RB NUMBER 06-30492
--------------	----------------	-------------------------

4 CODE	5 ITEM	6 QTY.	7 ITEM NAME	8 BRAND / MAKE MANUFACTURER	9 MODEL NAME OR NUMBER	10 MISC. DESCRIPTION	11 IDENTIFICATION / SERIAL NUMBER	12 VALUE
--------	--------	--------	-------------	-----------------------------	------------------------	----------------------	-----------------------------------	----------

- Supplemental Case Cleared
 Gang Domestic Hate Child Abuse Elderly Abuse

Connecting Report Numbers:

Code Section / Description: Officer Involved Shooting

Reclassify to:

Code: P-1 **Name:** Canley, Adrian Boyle

Deputy Shane Detective Matthews' Digital Audio Recorder

On 11-14-06 at about 1830 hours, Watch Commander, Captain Tom Convery, contacted me. Captain Convery told me that there had just been an officer involved shooting at [REDACTED] and requested I respond. I responded from the North Thousand Oaks area, arriving on scene at 1844 hours.

After arriving on scene and dealing with other issues, I took possession of Detective Shane Matthews' digital recorder from Detective Jon Smith. Detective Smith told me Deputy Paul Feruzza gave him Detective Matthews' digital recorder. On 11-15-06, I spoke to Deputy Feruzza in a telephone call. Deputy Feruzza told me that Detective Matthews handed him his (Detective Matthews') digital recorder after the shooting.

Recorder Description and Settings

Detective Matthews recorder was an Olympus, Puma Police Special model, digital recorder, serial number 202770GLP. The microphone sensitivity switch has two settings, "Conf" (conference – more sensitive) and "Dict" (dictation – less sensitivity). Detective Matthews' microphone sensitivity switch was positioned to the "Dict" (less sensitive) setting. The recorder also has a "VCVA" (voice activation) button with "On" and "Off" positions. Detective Matthews' recorder switch was positioned to the "Off" position. There is a "Hold" switch that was also in the off position. The recorder contained a 32-megabyte Olympus M-32P smart card.

There are three folders labeled alphabetically from A to C. There was one recording totaling 50 minutes and 45 seconds in folder "A." Upon listening to this recording, it is the recording that

13 DATE / TIME OF REPORT 12-07-06 / 1509	14 REPORTING OFFICER / ID NO / DIV / UNIT Sgt. M. Powers / #1365 / Special Services	15 APPROVED BY / ID NO Det. S. Peterson #2238
---	--	--

NARRATIVE REPORT VENTURA COUNTY SHERIFF'S DEPARTMENT

1 PD 9072	2 BEAT 9G01	3 RB NUMBER 06-30492
--------------	----------------	-------------------------

Page 2 of 10 Continuation

AGENCY IDENTIFIER CA0560000

4 CODE	5 ITEM	6 QTY	7 ITEM NAME	8 BRAND / MAKE MANUFACTURER	9 MODEL NAME OR NUMBER	10 MISC. DESCRIPTION	11 IDENTIFICATION / SERIAL NUMBER	12 VALUE
--------	--------	-------	-------------	-----------------------------	------------------------	----------------------	-----------------------------------	----------

contains an interview of [REDACTED] by Detective Matthews and the shooting. Folders "B" and "C" did not contain any files. I found there was 4 hours, 22 minutes and 32 seconds of (available – unrecorded) time remaining. The battery power meter showed three of three bars.

Time Clock

Detective Matthews' digital recorder has a date and time clock. On 11-15-06, at 1401 hours, I went to Sheriff's Dispatch to check the time differential between the dispatch system and Detective Matthews' digital recorder. The Dispatch Supervisor told me the dispatch time stamping system is synchronized with the atomic clock. I noted the following differential between Detective Matthew's digital recorder and the dispatch time clock:

Dispatch: November 15, 2006 – 1401 hours

Recorder: November 15, 2006 – 1403 hours

Detective Matthews' digital recorder time setting was set two minutes ahead of the Sheriff's Dispatch time settings.

Recording Title

PUMA0398.dss

Recording Length

According to the recording time stamps in Deputy Matthew's digital recorder, his interview with [REDACTED] began on November 14, 2006 at 1750 hours and that recording concluded on November 14, 2006 at 1841 hours, for a total of 50 minutes and 45 seconds.

Summary of Recording

The following is a summary of the contents of Detective Matthew's 50 minute and 45 second recording that are pertinent to the officer involved shooting. I have placed timestamp markings preceding events. The timestamp markings are in Minutes and Seconds, which correspond to their position in the recording.

13 DATE / TIME OF REPORT 12-07-06 / 1509	14 REPORTING OFFICER / ID NO / DIV / UNIT Sgt. M. Powers/#1365/Special Services	15 APPROVED BY / ID NO Det. S. Peterson #2238
---	--	--

NARRATIVE REPORT VENTURA COUNTY SHERIFF'S DEPARTMENT

Page 3 of 10

Continuation

AGENCY IDENTIFIER CA0560000

1 PD 9072	2 BEAT 9G01	3 RB NUMBER 06-30492
--------------	----------------	-------------------------

4 CODE	5 ITEM	6 QTY	7 ITEM NAME	8 BRAND / MAKE MANUFACTURER	9 MODEL NAME OR NUMBER	10 MISC DESCRIPTION	11 IDENTIFICATION / SERIAL NUMBER	12 VALUE
--------	--------	-------	-------------	-----------------------------	------------------------	---------------------	-----------------------------------	----------

The digital recording begins with Detective Matthews interviewing [REDACTED] [REDACTED] about an embezzlement. This interview lasts for 31 minutes and 8 seconds, which is when Detective Matthews ended the interview, telling [REDACTED], "See ya." Canley can first be heard speaking to Detective Matthews while Detective Matthews is in the process of ending his interview with [REDACTED].

30.17 Detective Matthews told [REDACTED] not to tell [REDACTED], don't even tell [REDACTED] that they talked. [REDACTED] told Detective Matthews he wouldn't. Detective Matthews said that would be ideal for him. Detective Matthews thanked [REDACTED].

30.28 Canley: You fuckers are Sheriff's huh. You guys are Sheriff's.

Matthews: Huh?

Canley: (INAUDIBLE) going to arrest me, or what?

Matthews: Well, what are you talking about?

Canley: (INAUDIBLE) --

[REDACTED]: -- Whose he? --

Canley: -- (INAUDIBLE)

[REDACTED]: I don't know. I don't know. I just stopped by to see my father. That was it. Anyway, um. But I promise you I, (INAUDIBLE).

Matthews: All right, see ya.

31.10 Rustling of the recorder begins and footsteps are heard as though Detective Matthews is running.

31.16 Detective Matthews begins repeating the command "Stop" 6 times. His voice gets louder and more affirmative as the commands continue.

31.20 A sound is heard that appears to sound like a car door slamming shut, immediately followed by a screeching sound that appears to sound like tire(s) breaking traction on a hard surface such as pavement or concrete. Detective Matthews yells "Stop" 8 more times, his voice growing more emphatic and louder with each command.

13 DATE / TIME OF REPORT 12-07-06 / 1509	14 REPORTING OFFICER / ID NO / DIV / UNIT Sgt. M. Powers/#1365/Special Services	15 APPROVED BY / ID NO. Det. S. Peterson #2238
---	--	---

NARRATIVE REPORT VENTURA COUNTY SHERIFF'S DEPARTMENT

Page 4 of 10

Continuation

AGENCY IDENTIFIER CA0560000

1 RD 9072	2 BEAT 9G01	3 RB NUMBER 06-30492
--------------	----------------	-------------------------

4 CODE	5 ITEM	6 QTY.	7 ITEM NAME	8 BRAND / MAKE MANUFACTURER	9 MODEL NAME OR NUMBER	10 MISC. DESCRIPTION	11 IDENTIFICATION / SERIAL NUMBER	12 VALUE
31.28			Two shots fired in rapid succession are heard. A loud hissing sound (consistent with refrigerant escaping from the air conditioning system after the air conditioning condenser of Canley's pick-up was hit by a bullet).					
31.29			Detective Matthews yells "Stop."					
31.30			Three more shots fired in rapid succession are heard.					
31.32			Detective Matthews yells, "Stop." Canley can be heard yelling something inaudible.					
31.34			Detective Matthews yells "Stop."					
31.35			Canley can be heard yelling, "Oh, I'm hit man."					
31.36			Detective Matthews yells "Stop."					
31.37			Canley can be heard yelling, "Oh, I'm hit. Oh (INAUDIBLE).					
31.39			A chirping sound (such as a tire striking a curb) can be heard.					
31.42			Detective Matthews is heard saying, "██████ go call 911!"					
31.44			Detective Matthews yells, "Stop, (INAUDIBLE), Stop!"					
31.46			Canley yells, (INAUDIBLE).					
31.47			Detective Matthews yells, "Stop!"					
31.48			Detective Matthews yells, "Stop!" Canley yells, (INAUDIBLE).					
31.49			Detective Matthews yells, "Stop!" Canley yells, "All right! Oooo! Ooooo!"					
31.58			Detective Matthews yells, "Get out of the truck!"					
32.00			Canley yells, "I can't!"					
32.03			Canley yells, "Oooo!"					
32.04			Detective Matthews orders Canley, "Do not move!" Canley replied, "I can't man!" Detective Matthews repeats, "Do not move." Canley replied, "Okay! That's it! Oooo (INAUDIBLE) man."					
32.23			Detective Matthews asked, "Where are you hit?" Canley replied, "My chest dude (INAUDIBLE). I'm, I'm going to let go of the brake right now. Alright?" Detective Matthews states, "Put the car in Park." Canley responds, "I can't." Detective Matthews repeated the command, "Put the car in Park."					
32.39			Detective Matthews asked Canley, "What is your name?" (a "beep" can be heard).					
32.56			Detective Matthews says, "Detective Matthews!"					
13 DATE / TIME OF REPORT			14 REPORTING OFFICER / ID NO / DIV / UNIT			15 APPROVED BY / ID NO		
12-07-06 / 1509			Sgt. M. Powers/#1365/Special Services			Det. S. Peterson #2238		

NARRATIVE REPORT VENTURA COUNTY SHERIFF'S DEPARTMENT

Page 5 of 10 Continuation

AGENCY IDENTIFIER CA0560000

1 PD 9072	2 BEAT 9G01	3 RB NUMBER 06-30492
--------------	----------------	-------------------------

4 CODE	5 ITEM	6 QTY	7 ITEM NAME	8 BRAND / MAKE MANUFACTURER	9 MODEL NAME OR NUMBER	10 MISC DESCRIPTION	11 IDENTIFICATION / SERIAL NUMBER	12 VALUE	
33.02			A beep can be heard (sounds like a Nextel telephone beep). Detective Matthews asked, "You there?" A voice on the other end of the phone can be heard stating, "Yeah." Detective Matthews states "Hey dude, I'm over at [REDACTED] Shots fired. I need code three back up right now." The voice responds, "Ten-four" (beep). Detective Matthews continues, "This is Detective Matthews and I got a suspect in the vehicle still, and he's hit in the chest."						
33.33			Detective Matthews continues to ask Canley what his name is twice.						
33.41			Some rustling of the recorder and other objects can be heard in the background along with some metallic sounds (such as car doors opening or closing).						
34.02			The wresting subsides and Detective Matthews repeats the command "Do not move" four times. Moans can be heard in the background. Rustling of the recorder can be heard.						
34.33			Detective Matthews states, "Stay with me," and repeatedly asked Canley his name again.						
34.42			Ignition keys can be heard turning and a vehicle (Canley's) engine is shut off. A bell (consistent with an alarm bell when a vehicle door is opened with the keys in the ignition) can be heard ringing. Some rustling can be heard.						
34.53			A vehicle door can be heard closing. Detective Matthews says, "Stay with me," then commands [REDACTED] to come to him. Detective Matthews repeats, "Stay here" four times, asking "What's your name" between stating, "Stay here." (as though he is talking to Canley).						
35.06			A siren can be heard in the distant background and growing louder as time passes.						
35.19			A voice can be heard saying "Hey, hey..." Detective Matthews asked, "What's your name?" The voice responds, "I'm just out here now." Detective Matthews asked, "Are you his friend?" The voice responds (INAUDIBLE - sounds like "Naw" or "Yeah"). Detective Matthews asked the person to stand by [REDACTED] next to a white car. Detective Matthews says, "Thank you." The recorder is rustling again as though Detective Matthews is moving.						
35.44			A siren that was growing louder stops (as though it was on Los Feliz in front of the apartment complex), but still at a distance.						

13 DATE / TIME OF REPORT 12-07-06 / 1509	14 REPORTING OFFICER / ID NO / DIV / UNIT Sgt. M. Powers/#1365/Special Services	15 APPROVED BY / ID NO Det. S. Peterson #2238
---	--	--

NARRATIVE REPORT VENTURA COUNTY SHERIFF'S DEPARTMENT

Page 6 of 10 Continuation

AGENCY IDENTIFIER CA0560000

1 RD 9072	2 BEAT 9G01	3 RB NUMBER 06-30492
--------------	----------------	-------------------------

4 CODE	5 ITEM	6 QTY.	7 ITEM NAME	8 BRAND / MAKE MANUFACTURER	9 MODEL NAME OR NUMBER	10 MISC. DESCRIPTION	11 IDENTIFICATION / SERIAL NUMBER	12 VALUE	
35.52			Detective Matthews asked, "██████, can you run down and get those guys?" More rustling of the recorder (Detective Matthews' movement) is heard and Detective Matthews repeats, "Stay here" and says "You got medical assistance on it's way", followed by a groan and Detective Matthews stating medical assistance is on it's way and then repeatedly asking "What's your name," (as though he is talking to Canley).						
36.23			A female voice (Deputy Natoli) is heard asking, "What do you need? What do you need?" Detective Matthews told the female he needed medical (personnel), gloves and a First Aid kit. A second male voice (Deputy Hall) asked if there was anyone outstanding. Detective Matthews told him, "No this is the only guy" and then commands someone "Back-up, back up. Sir go stand over there!" Another voice can be heard saying, "I'm the Manager." Detective Matthews continues, "He's still breathing." A male voice asked if he was needed for "CPR" (Cardiopulmonary Resuscitation). Detective Matthews said he didn't (need CPR), "He's still breathing. We got a pulse." The male voice asked if he needed pressure dressing. Detective Matthews said he needed pressure dressing and some gloves. Detective Matthews asked if anyone had scissors or a knife. Deputy Natoli said she had a knife.						
36.54			The male voice asked, "Shane, are you okay?" Matthew responded, "Yeah, I'm fine." The male voice asked if there was anybody outstanding. Detective Matthews said, "No he is the only guy." Deputy Natoli asked Detective Matthews what he needed. Detective Matthews directs (Deputy Natoli) to cut (Canley's) clothes off, "his (Canley's) shirt." Detective Matthews directed Deputy Natoli to cut up the side (of Canley's shirt) and stated, "The crank pipe in there, I don't, I was just trying to get ID." Detective Matthews directs Deputy Natoli where to cut the shirt off (Canley's shirt). Detective Matthews said, "He's hit right dead center, center punched him." Moans can be heard in the background and Detective Matthews repeatedly told Canley, "Stay here." Detective Matthews told someone he didn't know whom "this guy is." A male voice is heard saying Canley still has a pulse. It sounds as though they are trying to find where the bullet struck Canley, and then stated, "a single."						
38.19			Detective Matthews said, "I fired four times, just so you guys know." Detective Matthews is acknowledged by multiple voices. Detective Matthews continued,						

13 DATE / TIME OF REPORT 12-07-06 / 1509	14 REPORTING OFFICER / ID NO / DIV / UNIT Sgt. M. Powers/#1365/Special Services	15 APPROVED BY / ID NO Det. S. Peterson #2238
---	--	--

NARRATIVE REPORT VENTURA COUNTY SHERIFF'S DEPARTMENT

Page 7 of 10

Continuation

AGENCY IDENTIFIER CA0560000

1 RD 9072	2 BEAT 9G01	3 RB NUMBER 06-30492
--------------	----------------	-------------------------

4 CODE	5 ITEM	6 QTY.	7 ITEM NAME	8 BRAND / MAKE MANUFACTURER	9 MODEL NAME OR NUMBER	10 MISC. DESCRIPTION	11 IDENTIFICATION / SERIAL NUMBER	12 VALUE	
			<p>"There was a bullet on the floor right here." A male voice asked Detective Matthews, "Where's your weapon." Detective Matthews replied, "It's in my holster." The male voice asked Detective Matthews, "Do you need me to check down range for any other or did we have a good (INAUDIBLE) Shane? Detective Matthews replied, "Uh, there's, they're all into the truck, he tried to run me over, over here and." The male voice replied, "Okay." They continue to tell Canley "stay with us," and told Canley he is doing "okay." Canley can be heard moaning. Deputies are heard continuing to monitor Canley's vital signs and tell each other the results. Detective Matthews said he didn't even know who "this guy" (Canley) was and asked others at the scene to "run" (check) a (license) plate or look for identification to attempt to find out who he was.</p>						
39.33			<p>A male voice said, "Keith, Keith, look, let me do this. Just take him (Detective Matthews). Okay, okay, let me, let me take care of this. Just relax and just sort of, just kind of, you know what I mean. Just stay away (INAUDIBLE)..."</p>						
39.55			<p>A male voice asked Detective Matthews where he was. Detective Matthews directed the voice (to put crime scene tape up) the crime scene needed to go "straight across to that tree" and "up to the building... It happened right in here. He was in that parking spot next to the blue car."</p>						
40.15			<p>Detective Matthews told the person stringing the crime scene tape he would just stay with him. The male voice asked Detective Matthews if he was all right. Detective Matthews replied, "Yeah, I'm fine. The whole thing is..." The male voice reassured Detective Matthews he was going to be all right. Detective Matthews told ██████ that we were going to need to interview him. ██████ told Detective Matthews that he had to be somewhere and leave.</p>						
40.47			<p>Detective Matthews told ██████, "You saw, ██████, you saw everything that happened. You need to tell these guys exactly what you saw." Detective Matthews then directed someone to "██████, the guy in the red shirt."</p>						
41.08			<p>Deputy Natoli told Detective Matthews that the truck was registered to Adrian Canley. Detective Matthews asked Deputy Natoli, "can you run him (check to see if Canley had arrest warrants)?" Detective Matthews then continued, "He said he</p>						
13 DATE / TIME OF REPORT			14 REPORTING OFFICER / ID NO / DIV / UNIT			15 APPROVED BY / ID NO			
12-07-06 / 1509			Sgt. M. Powers/#1365/Special Services			Det. S. Peterson #2238			

NARRATIVE REPORT VENTURA COUNTY SHERIFF'S DEPARTMENT

Page 8 of 10 Continuation AGENCY IDENTIFIER CA0560000

1 RD 9072	2 BEAT 9G01	3 RB NUMBER 06-30492
--------------	----------------	-------------------------

4 CODE	5 ITEM	6 QTY.	7 ITEM NAME	8 BRAND / MAKE MANUFACTURER	9 MODEL NAME OR NUMBER	10 MISC. DESCRIPTION	11 IDENTIFICATION / SERIAL NUMBER	12 VALUE
--------	--------	--------	-------------	-----------------------------	------------------------	----------------------	-----------------------------------	----------

wasn't going, he wasn't going to be taken alive." A male voice said, "Wait, till, wait till... don't make any more statements." Detective Matthews interrupted, saying "I know, I know, I know. I just don't want you guys to..." The male voice reassures Detective Matthews that he doesn't doubt him at all, just don't make any more statements "until, you know." At this point a diesel engine (consistent with a fire engine or ambulance) can be heard idling nearby. Detective Matthews urged an unidentified person (probably [REDACTED]) to speak with an officer because he saw everything.

42.22 A fire engine can be heard pulling up near the recorder as well as the fire dispatch radio in the background.

Detective Matthews called his wife (on his cell phone) and notified her he had been involved in a shooting and he was all right, but was not going to come home for a while; "only the suspect was shot, by me."

43.23 A male voice asked Detective Matthews, "You haven't tach loaded or anything." Detective Matthews replied, "Nothing. I de-cocked and holstered and I pulled him out of the van, or the truck; that's all I've done." Detective Matthews and another male speak about Detective Matthews not having a radio, but told dispatch he was at the location. Detective Matthews said he told the person he was interviewing to call 911. Detective Matthews said unit "Ocean forty-one" (patrol unit (9O41) was the only person who responded to his Nextel call(s). Detective Matthews said he told Deputy Feruzza he was just in a shooting, needed code three back up, his location and then hung up.

44.11 A male voice told Detective Matthews to move away from the scene until supervisors arrived. Detective Matthews speculated "she" (Deputy Natoli's car) was probably on his shell casings. A male voiced asked Detective Matthews other than [REDACTED], was there any other persons that needed to be interviewed. Detective Matthews said there was a "little Hispanic guy" that walked up to him and tried to help, who he told to go stand with [REDACTED]. Detective Matthews said he tried to call (patrol units) 9G, 9D, 9J and Feruzza (9O) was the only one that answered (the cell phone). Detective Matthews said he only saw two people, the person he was interviewing ([REDACTED])

13 DATE / TIME OF REPORT 12-07-06 / 1509	14 REPORTING OFFICER / ID NO / DIV / UNIT Sgt. M. Powers/#1365/Special Services	15 APPROVED BY / ID NO Det. S. Peterson #2238
---	--	--

NARRATIVE REPORT VENTURA COUNTY SHERIFF'S DEPARTMENT

Page 9 of 10

Continuation

AGENCY IDENTIFIER CA0560000

1 RD 9072	2 BEAT 9G01	3 RB NUMBER 06-30492
--------------	----------------	-------------------------

4 CODE	5 ITEM	6 QTY	7 ITEM NAME	8 BRAND / MAKE MANUFACTURER	9 MODEL NAME OR NUMBER	10 MISC. DESCRIPTION	11 IDENTIFICATION / SERIAL NUMBER	12 VALUE
--------	--------	-------	-------------	-----------------------------	------------------------	----------------------	-----------------------------------	----------

██████████) and the other Hispanic guy that walked up on him. Detective Matthews described the Hispanic male as 5-6, real thin, 140, long hair, no shirt, white shorts, barefoot, no facial hair, around 20 years old. Detective Matthews said he didn't know if the Hispanic male saw the shooting. Detective Matthews explained that he pulled Canley out of the pick-up and the Hispanic male came over to him. Detective Matthews said he asked the Hispanic male if he knew "this guy" (Canley). The Hispanic male said he didn't know him. Detective Matthews said he directed the Hispanic male to go stand with ██████████.

Deputy Natoli said she found an Adrian Doyle Canley who lived in Port Hueneme, that was not on probation or anything like that and his driver's license was valid. A male voice told Detective Matthews that he could go to his car and sit down. Detective Matthews declined and said, "I just hope he doesn't die." The male asked, "Huh?" Detective Matthews replied, "I said, I hope he doesn't die. As much as I (either "did" or "didn't") like what happened, I hope he doesn't die." In the background a male voice can be heard stating that all the proper notifications are being made and other details relating to securing the scene. A male said he was going to stay with Detective Matthews and Detective Matthews asked a Sergeant if it was all right if "Paul" (Feruzza) stayed with him. They discussed the personnel on scene. Detective Matthews said, "You know how you always second guess sometimes, second guess yourself." A male voice told Detective Matthews not to do that. The male directed Detective Matthews to his car. A car door is opened. Detective Matthews said he wanted to watch to see what was going on with (Canley), it was probably better to "keep my brain occupied for a little bit." Detective Matthews remarked, "It's amazing how you don't even hear those gunshots though." I heard rustling as though Detective Matthews was reaching for his recorder and then he said "Paul" and the recording ends.

Recording Disposition

I transferred the recording to a compact disk on 11-15-06 at 1030 hours. I booked the smart card containing the original recording and the compact disk containing the transferred version of

13 DATE / TIME OF REPORT 12-07-06 / 1509	14 REPORTING OFFICER / ID NO / DIV / UNIT Sgt. M. Powers/#1365/Special Services	15 APPROVED BY / ID NO Det. S. Peterson #2238
---	--	--

NARRATIVE REPORT VENTURA COUNTY SHERIFF'S DEPARTMENT

1 RD 9072	2 BEAT 9G01	3 RB NUMBER 06-30492
--------------	----------------	-------------------------

Page 10 of 10 Continuation

AGENCY IDENTIFIER CA0560000

4 CODE	5 ITEM	6 QTY.	7 ITEM NAME	8 BRAND / MAKE MANUFACTURER	9 MODEL NAME OR NUMBER	10 MISC. DESCRIPTION	11 IDENTIFICATION / SERIAL NUMBER	12 VALUE
--------	--------	--------	-------------	-----------------------------	------------------------	----------------------	-----------------------------------	----------

the recording into evidence at the Ventura Property Room on 11-16-06. Detective Matthews' digital recorder was returned to him, less the smart card.

13 DATE / TIME OF REPORT 12-07-06 / 1509	14 REPORTING OFFICER / ID NO / DIV / UNIT Sgt. M. Powers/#1365/Special Services	15 APPROVED BY / ID NO. Det. S. Peterson #2238
---	--	---

NARRATIVE REPORT VENTURA COUNTY SHERIFF'S DEPARTMENT

Page 1 of 1

Continuation

AGENCY IDENTIFIER CA0560000

1 RD	2 BEAT	3 RB NUMBER
9072	9G01	06-30492

4 CODE	5 ITEM	6 QTY.	7 ITEM NAME	8 BRAND / MAKE MANUFACTURER	9 MODEL NAME OR NUMBER	10 MISC. DESCRIPTION	11 IDENTIFICATION / SERIAL NUMBER	12 VALUE
--------	--------	--------	-------------	-----------------------------	------------------------	----------------------	-----------------------------------	----------

Supplemental Case Cleared

Gang Domestic Hate Child Abuse Elderly Abuse

Connecting Report Numbers:

Code Section / Description: Officer Involved Shooting

Reclassify To:

Code: P **Name:** Canley, Adrian [REDACTED]

Transcript of Digital Audio Recording

On 12/04/06, I reviewed the digital audio recording Detective Shane Matthews created during his contact with [REDACTED] [REDACTED], and his subsequent encounter with Adrian Canley. Sergeant Powers provided me with a copy of the recording, and he also provided me with a typewritten transcript of the recording.

I listened to the entire audio recording and I compared it with the typewritten transcript. After a careful review, I confirmed the typewritten transcript is an accurate representation of the contents of the digital audio recording. Refer to the attached transcript and the digital audio recording for specific details.

13. DATE / TIME OF REPORT 12/04/06/ 4:58 PM	14. REPORTING OFFICER / ID NO / DIV / UNIT BA Sgt. W. Ayub/#3318/Special Services	15. APPROVED BY / ID NO [Signature] #1917507
--	---	---

T R A N S C R I P T

DIGITAL AUDIO RECORDING OF VENTURA COUNTY SHERIFF'S DETECTIVE SHANE MATTHEWS INTERVIEW OF [REDACTED] [REDACTED] AND THE OFFICER INVOLVED SHOOTING OF ADRIAN CANLEY ON NOVEMBER 14, 2006.

Legend: SM = Shane Matthews
GC = [REDACTED] [REDACTED]
AC = Adrian Canley
PF = Paul Ferruzza
LN = Laura Natoli
KH = Keith Hall
CP = Cary Peterson
MV = Male Voice

GC: The GNC? Uh, yeah.

SM: I'm not here to arrest you.

GC: No, no. I'm going to tell you --

SM: But I -- I do want to talk to you about it.

GC: No, that's fine.

SM: Okay. Your parent -- do you live here?

GC: I stay, sometimes, most of the times I stay.

SM: Okay. I just talked to your mom and is -- is it your brother?

GC: Yeah.

SM: And they said you're kind of in and out and not --

GC: Yeah.

SM: -- not really staying in one place in particular. So --

GC: No.

SM: -- lay it on me. What's going on?

GC: I didn't -- did I take anything from there, no.

SM: Okay.

GC: No.

SM: So what was going on?

GC: Some people -- did some people take anything, I don't know.

1 SM: Well, you do know. I mean, you told the management that
2 you knew.
3 GC: I didn't tell management anything at all.
4 SM: Well, you said I'm not going down for it, right?
5 GC: Down for what? I -- no, I --
6 SM: Okay, well --
7 GC: -- I didn't -- I wasn't there at that day.
8 SM: The -- well, it wasn't just one day.
9 GC: That -- there --
10 SM: There was multiple days.
11 GC: No, no, no, no. I'm talking about Friday.
12 SM: Friday? What was Friday?
13 GC: There was supposed to be a meeting on Friday. All I know
14 is that we were all getting fired. All three of us.
15 SM: My understanding was that you -- it was just you and [REDACTED]
16 working there?
17 GC: Right. [REDACTED] sometimes.
18 SM: Who's [REDACTED]? I didn't know she was working there.
19 GC: Yeah. She -- she was coming in sometimes.
20 SM: Was she the one that got hurt and was off on some -- like
21 an injury thing or something like that?
22 GC: Um -- no.
23 SM: Was one of your managers off on an injury?
24 GC: No, no. She supposedly had breast cancer.
25 SM: Oh, and that was [REDACTED]?
26 GC: Yeah. No, that was [REDACTED].
27 SM: Okay. So [REDACTED] s a different person that --
28 GC: [REDACTED] s a different person.

1 SM: -- that worked there also.

2 GC: Right, right. Right.

3 SM: Okay.

4 GC: But once in a week -- once a week.

5 SM: Okay. So what do you know that was going on there?

6 GC: I'll put it to you this way: I was not the only one with a
7 key.

8 SM: Uh-huh.

9 GC: Do you understand?

10 SM: Uh-huh.

11 GC: Now, I don't know how this worked out. But when my boss
12 was there they did a inventory. I started there December
13 14th and then I left --

14 SM: Of '0- --

15 GC: End of December.

16 SM: -- of '05? December 14th, '05?

17 GC: Yeah, yeah, yeah. Of '05.

18 SM: Okay.

19 GC: Yeah. Yeah. Then I left and I was there part-time. Okay?
20 Then I left over the summer.

21 SM: Okay.

22 GC: Or I mean -- I mean, with -- last summer I just had left.

23 SM: Okay.

24 GC: But --

25 SM: I'm just writing down the date you started, that's all.

26 GC: No, no. That's fine, fine. But what I don't -- the thing
27 is, is that I guess they had an inventory control.

28 SM: Uh-huh.

1 GC: And they were short like five or six thousand dollars.
2 SM: Eleven thousand dollars.
3 GC: Right. And then, okay, then she left.
4 SM: The shortage -- the shortage that I'm investigating is from
5 the time that just you and ██████ were there. It's not
6 from that time that anybody else was there.
7 GC: I'll put it to you, after I left and ██████ knows this
8 'cause I called him right afterwards. My district manager
9 came in and said we need a key for -- to redo the whole
10 store in a mor- -- or to actually help put stickers are --
11 on -- in the morning.
12 SM: Uh-huh.
13 GC: Me and some other people. I said that's fine. When I got
14 there I figured I'd help out. So the next day everybody
15 was there and this is around -- now we opened up the store
16 at 10:00.
17 SM: Uh-huh.
18 GC: So I was there around maybe 8:30 or so. And they were
19 already there.
20 SM: This is the day of the meeting for the -- put the stickers
21 on?
22 GC: Right.
23 SM: You're talking about?
24 GC: Right.
25 SM: Okay.
26 GC: This was after my manager had left.
27 SM: Okay.
28 GC: I -- we -- the guy was so upset of how messy it was.

1 SM: Uh-huh.

2 GC: He took out a lot of things. We had more things. Like for
3 example, bottled water.

4 SM: Uh-huh.

5 GC: We had two cases. And he took them.

6 SM: Who's he?

7 GC: But -- my district manager.

8 SM: Okay.

9 GC: But the problem is, is that a lot of things weren't
10 scanned; do you understand?

11 SM: Uh-huh. Well, okay. Here -- here's the deal.

12 GC: Right.

13 SM: These are the things that I know. I know that you and
14 [REDACTED] were working there.

15 GC: Right, right. I was actually there --

16 SM: I know, I know for sure that some things were sold for cash
17 over the counter without being a transaction 'cause I have
18 witnesses; they have confirmed that -- with [REDACTED] and with
19 you. Now, I don't know if those transactions were
20 aboveboard or under board. But the -- but the truth of the
21 matter is, that if I don't get -- start getting honest
22 answers, then you're going to be a suspect, not just a
23 witness.

24 GC: Right. But then --

25 SM: So tell me what's going on 'cause you know a lot more than
26 what's going on.

27 GC: Right. I was there. I'll put it to you this way: I was
28 there sixty hours a week.

1 SM: I don't want -- okay.

2 GC: Okay?

3 SM: I --

4 GC: I was there a lot of times. But I'm just telling you now
5 that no -- not me and as far as I know not [REDACTED], did any
6 transactions.

7 SM: He did those transactions in front of you.

8 GC: No.

9 SM: The witness told me that. So don't tell me he didn't do --
10 he didn't have cash --

11 GC: I did not --

12 SM: -- sales in front of you.

13 GC: I did not see anything, no.

14 SM: [REDACTED].

15 GC: I'm telling you the truth. I would not --

16 SM: Okay. How does eleven thousand dollars --

17 GC: Thousand dollars get missed? That's what -- okay, A, I
18 don't know if it was this eleven thousand. But all I know
19 is like Shane and all that, came in that day.

20 SM: Uh-huh.

21 GC: And they took a lot of stuff that the -- was not scanned.

22 SM: Shane?

23 GC: The district manager.

24 SM: Okay.

25 GC: They -- they -- it was so messy that they started bringing
26 stuff out the back door.

27 SM: What types of things did he take that day besides bottled
28 water 'cause I have a --

1 GC: Dude --
2 SM: -- I have a list.
3 GC: -- we're going -- we're going off by everything. That --
4 the whole thing. I don't know what was there.
5 SM: I have a list of everything that's missing.
6 GC: Okay. The, probably the half of the store or more.
7 SM: He took it?
8 GC: Out of the back trying to clean up the store. But it was
9 gone, I'll put it to you that way.
10 SM: So what you -- this is what I'm hearing you telling me.
11 You're telling me that -- that [REDACTED], the district manager,
12 removed a bunch of merchandise.
13 GC: (INAUDIBLE) he -- he didn't --
14 SM: Before the stickers were put on and before anything was
15 scanned and therefore --
16 GC: Right.
17 SM: -- that's --
18 GC: Before it was scanned, a lot of things --
19 SM: And that's why it's unaccounted for?
20 GC: A lot of things were being taken out, were being supposedly
21 straightened up. I was there at the store.
22 SM: So --
23 GC: When this was happening.
24 SM: So you don't think [REDACTED] did anything, even though I got
25 (INAUDIBLE) --
26 GC: I never saw him do anything.
27 SM: But you think [REDACTED] did?
28 GC: I don't know.

1 SM: Here -- here's what I don't understand, [REDACTED], here's
2 what I don't understand. If that's true, if that's true,
3 then why did you and [REDACTED] quit the day you find out that
4 -- that there's --
5 GC: 'Cause we were being fired. We were getting fired and we
6 wanted to leave. We had (INAUDIBLE).
7 SM: But you -- but why were you getting fired?
8 GC: Because apparently [REDACTED] didn't even like -- like us in the
9 beginning. I mean, think of mutiny.
10 SM: But you guys knew there was missing -- missing merchandise
11 at the time 'cause I know that Ito or whatever that guy's
12 name is, he told you this is what's going on. I'm missing
13 merchandise and they're -- they're looking at you guys --
14 GC: Right.
15 SM: -- for stealing it.
16 GC: Right. They were looking at --
17 SM: You guys said screw it.
18 GC: Right, right, right.
19 SM: I'm outta here.
20 GC: No, no, no, no. But, no.
21 SM: So, what?
22 GC: This was being -- this stuff was missing when -- before
23 [REDACTED] had left for the cancer. Now, eleven thousand,
24 you're telling me eleven thousand dollars within one month
25 is missing. That is -- I -- I don't know.
26 SM: Not -- not one month. I think the -- the time spread was
27 maybe --
28 GC: One month.

1 SM: No, I think it was longer than that. It was maybe like --
2 GC: One month.
3 SM: -- like three months maybe.
4 GC: (INAUDIBLE).
5 SM: I think three months total, maybe. How long was -- was the
6 -- the girl, the other girl gone with the breast cancer?
7 GC: Wasn't -- July 29th her benefits got cut off. We left,
8 when, August? It wasn't -- I don't think it was three
9 months. I don't know exact dates so, but it wasn't that
10 long. I think the most -- longest would have been two
11 months.
12 SM: Why -- why --
13 GC: I mean, eleven thousand dollars in two months. That's --
14 SM: Well, let me clarify this. I asked -- I forget who the
15 district manager is now, but I --
16 GC: [REDACTED].
17 SM: I -- no. Somebody else I talked to.
18 GC: [REDACTED]?
19 SM: And I said -- [REDACTED], that's his name.
20 GC: Right. He's not district manager, he's loss prevention.
21 SM: Okay. And I said, you know, when I think of eleven
22 thousand dollars, I think of like tons and tons of stuff.
23 And he said actually some of the stuff at GNC is pretty
24 pricey so if you steal one jug of like a protein powder,
25 that could be a hundred and fifty bucks by itself right
26 there. Is that true? So --
27 GC: No protein in the world is --
28 SM: -- so think --

1 GC: -- a hundred fifty dollars.

2 SM: So -- so he's saying well, you know, if you take -- if you
3 take, you know, ten items of this that would be a thousand
4 dollars so people don't realize how fast it adds up.

5 GC: No. I -- I --

6 SM: Is that possible?

7 GC: No.

8 SM: You don't think so?

9 GC: No. Eleven thousand dollars? You -- you -- you --

10 SM: You -- you would know. I don't work at GNC. I never had.

11 GC: Eleven -- no, no. I understand. Eleven thousand dollars
12 -- any -- any place eleven thousand dollars is not. It's
13 -- I mean, there's no way that that store has eleven
14 thousand dollars.

15 SM: You say --

16 GC: I mean -- I mean -- I mean, the whole store might have
17 eleven thousand dollars but no -- but I mean, you're
18 telling me within two months or three months --

19 SM: Yeah.

20 GC: -- eleven thousand is missing.

21 SM: That's what they're saying.

22 GC: That -- that's a huge difference.

23 SM: Uh-huh.

24 GC: Now, if it is missing, I could tell you a lot of stuff from
25 that is when that day when Shane and a few other people
26 came in and took everything. To clean up.

27 SM: And that --

28 GC: 'Cause it was too messy. But --

1 SM: And then after that day is when they started keeping track
2 of items using a scanning device? You're saying they put
3 the stickers on them and they would scan them and then log
4 them in? Is that how it worked?

5 GC: Not -- I -- that I never saw.

6 SM: Okay.

7 GC: That -- that never happened.

8 SM: What about -- did you ever do any cash transactions over
9 the counter not using the register?

10 GC: No.

11 SM: So if I have a witness that says they -- they bought a --
12 some merchandise from you for cash and that you never used
13 a register and just -- and never gave them a receipt,
14 they're not telling the truth?

15 GC: That's right. I never did any cash transactions.

16 SM: Did [REDACTED] ever do any cash transactions?

17 GC: I never saw that, no.

18 SM: Did he ever talk to you about it?

19 GC: No. And I don't know who would say that about [REDACTED] at
20 all.

21 SM: People that don't even know you, don't even him, don't even
22 know me. They're just random people that came in and said
23 these guys sold me merchandise --

24 GC: There was a ru- -- there was a rumor --

25 SM: -- for half price.

26 GC: There was a rumor too. That -- that Ito --

27 SM: Uh-huh.

28 GC: -- was supposed to get a lot -- a promotion if, for some

1 reason, if he gets me or [REDACTED] or somebody.
2 SM: That's not true at all. I talked to Ito.
3 GC: Or a letter of recommendation.
4 SM: No. Not at all.
5 GC: I heard it from somebody who worked at the mall when I was
6 walking by to go to work up there.
7 SM: I'm -- like I told you, I'm not here to arrest you.
8 GC: No, no. I'm not --
9 SM: I'm here --
10 GC: I --
11 SM: -- to -- just to ask you questions.
12 GC: No, I understand that.
13 SM: I -- I told your brother, I said --
14 GC: But I'll -- I'll put it --
15 SM: -- I'm not going to jump to conclusions.
16 GC: -- I'll put it to you this way though. I'm not the only
17 one who had a key. Now, [REDACTED], I don't -- I never saw him
18 take anything or sell anything without the register.
19 SM: But you two were the only people in the store.
20 GC: Right, right.
21 SM: For many, many shifts.
22 GC: Right. Actually I was a lot of times too. I mean, I had
23 sixty hours a week on.
24 SM: That's a lot.
25 GC: No, that is a lot. And I had to quit my other jobs for it
26 too.
27 SM: I want to -- I want to believe you but the -- the pieces
28 aren't adding up and I'm -- I want you to be completely

1 honest with me.

2 GC: I am.

3 SM: Because the problem is --

4 GC: Because --

5 SM: -- listen, if the problem is, if I talk to these other
6 people and I talk to [REDACTED] and I talk to [REDACTED] and I find
7 out that what's going on -- if somebody spills the beans
8 and -- and then I find out what's really going on, and
9 everything you say after that's not going to hold water.

10 GC: No, I understand.

11 SM: Okay.

12 GC: But if you want that money, go look at that morning.
13 'Cause right they left I called [REDACTED]. I mean, I called
14 [REDACTED] at JC Penney.

15 SM: Uh-huh.

16 GC: I said, hey, listen, this is what happened. And he came in
17 and nothing was scanned. I mean, for example we have like
18 three bottles of water.

19 SM: When you say -- when you say scanned, what do you mean?

20 GC: Well, okay, if I walk in --

21 SM: I'm thinking inventory, like someone goes around and --

22 GC: Right. That's what I'm talking about.

23 SM: Okay. So they scan --

24 GC: Okay? Let -- let's --

25 SM: -- in the morning, everything.

26 GC: Let's say -- right, right. Let's say you -- you want a
27 (INAUDIBLE) right here.

28 SM: Okay.

1 GC: You take this one. Okay? Well, you throw it in a box with
2 other stuff but you didn't scan on the register. So in my
3 register it shows that we have it. You -- do you
4 understand?

5 SM: Right. So, but if the -- if the item was never scanned in
6 the first place how would they know it's missing?

7 GC: Be --

8 SM: You know what I mean? Like --

9 GC: Right, right.

10 SM: Because they didn't -- they didn't keep track of inventory
11 in the beginning.

12 GC: No, no, no, no. Because it's not there. Let's say you --
13 let's say you had a -- a bottle.

14 SM: Okay.

15 GC: Okay? Let's say you had a bottle. And let's say you were
16 the manager and you decide you want to do an inventory.

17 SM: Okay.

18 GC: So you take the bottle and you scan it and shows that you
19 have five, but you know what, you seen it yourself you only
20 have two.

21 SM: So you guys didn't keep track? The -- the system didn't
22 keep track of individual bottles? It just kept track of --
23 of general quantities?

24 GC: Right.

25 SM: So --

26 GC: That's what they were basing it off of.

27 SM: Okay.

28 GC: Now remember too, a lot of stuff expires.

1 SM: Uh-huh.

2 GC: Okay? And we had a lot of stuff that had expired.

3 SM: So what do you do with the expired?

4 GC: Throw it out as far -- is what I saw when the manager did
5 it. And then right when my manager left I never touched
6 anything or did anything like that about scanning it or
7 throwing it out 'cause I didn't know how to.

8 SM: Were there video cameras inside GNC?

9 GC: No, unfortunately.

10 SM: Do you know if video cameras were placed in there secretly
11 to watch you guys?

12 GC: Not that I know of.

13 SM: Would you be surprised if I told you there was?

14 GC: Probably.

15 SM: I have not seen any video but I --

16 GC: I --

17 SM: -- I'm just giving you a fair -- a fair shot --

18 GC: That's fine.

19 SM: -- to say --

20 GC: That's fine.

21 SM: -- come clean now.

22 GC: Did I, no. Did I see anybody do anything including me, no.
23 And I don't know who said that about [REDACTED].

24 SM: Well, [REDACTED]'s no angel, you know that. I mean, look at,
25 you have to know that. Come on, [REDACTED], you know [REDACTED]'s
26 no angel. You -- you of all -- I mean, you have no record,
27 you've never been in trouble before, nothing serious that I
28 can find, right?

1 GC: Except for the tickets.
2 SM: Ah --
3 GC: Speeding ticket (INAUDIBLE).
4 SM: Tickets. Yeah, that's nothing. [REDACTED] s been in a lot of
5 trouble before.
6 GC: (INAUDIBLE).
7 SM: He has -- I'm positive about that.
8 GC: Yeah, yeah, yeah.
9 SM: He's no angel. I'm just saying the reason I came to talk
10 to you first is because --
11 GC: I'll put it to you --
12 SM: -- is because you have a lot to lose. He -- he's already
13 lost a lot of stuff already. So it's no big deal to him.
14 GC: I'll -- I'll put it to you also. Like a said, I also --
15 and I told [REDACTED], I'm not the only one who had a key.
16 SM: Who -- who all? Shane and [REDACTED]. That's it, right?
17 GC: From a certain time. Do you understand? A --
18 SM: No. Just tell me what you're thinking. Please. I'm not
19 -- it's going to come out in the end anyway.
20 GC: I'll put it to you, anytime somebody leaves they have to
21 turn in their key.
22 SM: So if they're -- so if -- I'll use myself as an example.
23 If I'm an employee at GNC and I leave to use the restroom,
24 I give my key?
25 GC: No, no, no, no.
26 SM: No?
27 GC: Not like that.
28 SM: Okay.

1 GC: If you're sick --
2 SM: Okay.
3 GC: -- and let's say you're going to be on leave --
4 SM: Uh-huh.
5 GC: -- for some time, you got to leave your key.
6 SM: Okay.
7 GC: (INAUDIBLE).
8 SM: Okay. Who do you leave it with, though?
9 GC: Anybody. Manager, anybody.
10 SM: So you could leave yours with [REDACTED]?
11 GC: (INAUDIBLE).
12 SM: He could leave you -- his with you? You --
13 GC: Well, as far as I know, we're supposed to give it -- I
14 mean, I assumed when -- when I turned in my key I gave it
15 to [REDACTED].
16 SM: Uh-huh.
17 GC: Who was my manager.
18 SM: Okay.
19 GC: But I assume when you turn in the key you would have to
20 give it to -- let's say you're a manager?
21 SM: Uh-huh.
22 GC: You wouldn't give it to me necessarily. Wouldn't you give
23 it to a district manager?
24 SM: Depends on the policy.
25 GC: Well, come on. You have an employee and no -- working at a
26 store.
27 SM: Uh-huh.
28 GC: Who is only an employee. And no manager at the store.

1 SM: Then the employee would probably get the key.
2 GC: You think so, or a district manager would get the key.
3 (INAUDIBLE).
4 SM: The district manager's not there every day, right?
5 GC: Right. But -- but why would you leave it with a -- so
6 you're going to let an employee doesn't know how to do
7 anything, give it to a key? (INAUDIBLE).
8 SM: Don't you guys open and close and open the registers?
9 GC: Right, right.
10 SM: And all that kind of stuff?
11 GC: Right, right, right. We do all that.
12 SM: That's the key you're talking about?
13 GC: But -- but we --
14 SM: You're talking about a key to open and close the business
15 and --
16 GC: Right, right.
17 SM: -- open the register and --
18 GC: Well, there's one key.
19 SM: -- access merchandise?
20 GC: There's only one key to open up the register. I mean, open
21 up the store. There's another key for register.
22 SM: Okay. Okay.
23 GC: Did you -- do you --
24 SM: I'm -- I'm not quite following. If somebody -- just tell
25 me what you're thinking.
26 GC: No. Okay, let's say your my manager.
27 SM: Straight -- okay.
28 GC: Okay. You're sick, you leave. Okay?

1 SM: Okay.

2 GC: Now, right -- the day you leave, you're supposed to give me
3 your key. Or not -- or give -- I would assume --

4 SM: You're supposed to give your key to somebody.

5 GC: Kind of higher than you like a district manager. 'Cause
6 you don't leave -- without a man- -- if you weren't a
7 manager --

8 SM: Uh-huh.

9 GC: -- and you worked at a store and there's no manager for a
10 store --

11 SM: Uh-huh.

12 GC: -- I mean, what does that tell you? Do you know what I
13 mean?

14 SM: You're saying if I'm the manager and you're the employee --

15 GC: Uh-huh.

16 SM: -- and I go home sick, wouldn't I leave my key with a
17 higher authority --

18 GC: Right.

19 SM: -- versus an employee?

20 GC: Right.

21 SM: And what you're telling me is that --

22 GC: Because here is an employ- -- because especially with one
23 employee who has no man- -- who -- who has no supervision
24 for a store.

25 SM: Which is [REDACTED]?

26 GC: Or [REDACTED]. I have no supervision for a store. Do you
27 understand? I mean --

28 SM: Right.

1 GC: -- I'm there opening, you know, and I'm working there all
2 day but I have no supervision.

3 SM: But there were several -- several months where you guys
4 worked there without a manager.

5 GC: Right.

6 SM: Or not several but two months, right?

7 GC: Two months. Right. That's what I'm trying to tell you.
8 When -- I'll put it to you this way (INAUDIBLE) find out
9 when -- I mean, when was the key turned in by my manager?

10 SM: Okay. So what does that have to do with the theft though?
11 I'm trying to -- I'm trying to re- -- I'm trying to
12 understand what you're telling me.

13 GC: 'Cause you're -- you're talking about products that's
14 missing.

15 SM: Yeah. So if the employee had the key that the manager is
16 supposed to have then you're saying the employee had access
17 to all the merchandise?

18 GC: No.

19 SM: See, I'm not understanding. Just tell -- tell -- is there
20 -- is there some secret that I'm trying -- I'm missing?

21 GC: Kind of. I mean, it --

22 SM: Just tell me straight up. You want to go inside and talk?
23 No one's inside. Your mom and brother are gone.

24 GC: (INAUDIBLE) just left.

25 SM: I know. You want to go inside and talk where it's quiet?

26 GC: I'll -- I'll sit with you here. If I tell you it's -- it's
27 between us two.

28 SM: Okay. Fair enough.

1 GC: I mean, I'm not going to -- I'll put it to you this way: I
2 do not want to be under a lamp inside a courtroom or
3 anything.

4 SM: Okay. Fair enough.

5 GC: [REDACTED], my boss, she was very pissed at GNC and the key
6 wasn't turned in 'til later. If I tell you, it's between
7 us two.

8 SM: Uh-huh.

9 GC: Right?

10 SM: Uh-huh.

11 GC: Yes? I mean --

12 SM: Yes.

13 GC: Did I know anything about her still having a key and what
14 she could do with it, yes.

15 SM: Do you have specific knowledge that she took anything?

16 GC: She still had the key.

17 SM: You're shaking your head yes. And then --

18 GC: (INAUDIBLE) and she still had the key.

19 SM: [REDACTED], what -- what your body language is telling me is
20 that you know, you just don't want to say it. How am I
21 supposed to -- how am I supposed to catch her or whoever
22 did it unless you tell me how I can catch her? How --
23 where --

24 GC: She left. I mean, afterwards. I mean, what's --

25 SM: But was she able to come back?

26 GC: She had the key.

27 SM: So what happened? Tell me. What -- what day? I mean,
28 help me -- I can look at the video or something.

1 GC: She had the key for -- for a while. I mean, you know.
2 SM: Do you know if she came back and took anything? The
3 answer's yes or no, [REDACTED].
4 GC: I -- I think she came back.
5 SM: How -- okay. GN- -- how is she going to move any product
6 from the store? I mean eleven thousand, that's a -- that's
7 a lot of stuff.
8 GC: That is a lot of stuff. That's why I'm saying not even,
9 there wasn't eleven thousand taken. Nobody took eleven
10 thousand dollars worth of product. There's no way.
11 SM: So how much did she take?
12 GC: I don't know.
13 SM: Do you even know if she came back?
14 GC: Yes.
15 SM: How many times?
16 GC: As far as I knew once.
17 SM: Were you there or was it alone, like she came when no one
18 else was there?
19 GC: Am I going to get arrested?
20 SM: No.
21 GC: Was I there, yes.
22 SM: Did you see what she took? What did she take? Come on, I
23 have the list.
24 GC: She -- she -- no. She took. Maybe the suitcase was half
25 full, you know (INAUDIBLE).
26 SM: I -- we're good.
27 GC: She took a suitcase (INAUDIBLE) but it wasn't one thousand
28 that day.

1 SM: Do you think it was stuff that she's just going to use or
2 do you think it's stuff that she was giving to people or
3 what do you think?
4 GC: I don't know. Probably she was going to use.
5 SM: She had never done it before?
6 GC: She was pissed at GNC. Pardon?
7 SM: She'd never done it before?
8 GC: You know, did she ever do it before? That I don't know.
9 It's --
10 SM: Yeah. But, 'cause I'm talking about what you know. I'm
11 not trying --
12 GC: No, no. When I know she (INAUDIBLE). But before, I mean,
13 before I started there, when they did the whole inventory
14 they were five thousand dollars --
15 SM: Short?
16 GC: -- short and before.
17 SM: -- or missing, missing.
18 GC: Of missing.
19 SM: And one suitcase isn't five thousand bucks.
20 GC: No. No. And let me tell you something. There was not
21 eleven thousand dollars that -- there's no way. You're
22 telling me -- you're telling me it adds up when a protein
23 shake's a hundred and fifty dollars? No.
24 SM: Well, I didn't make the list.
25 GC: No, no, no, no.
26 SM: I'm just saying.
27 GC: I know, I know.
28 SM: That's what they're saying.

1 GC: There's no way. But I could tell you this much, there was
2 probably the other half or more was probably done by the
3 inventory by [REDACTED].

4 SM: Hmm.

5 GC: Do you understand?

6 SM: Yeah.

7 GC: There -- there's --

8 SM: See, what about -- here -- here's what I'm -- what I'm
9 getting at. What about -- see, one of the persons
10 specifically identified [REDACTED] as doing cash transactions.

11 GC: I never -- I never --

12 SM: I mean, a suitcase full of stuff, big deal. Right? That's
13 maybe what, a hundred, two hundred bucks?

14 GC: We -- but the -- the -- we're missing the -- we're miss --
15 maybe more than that.

16 SM: How much more?

17 GC: More. I -- I can't give you specifics.

18 SM: From mul- --

19 GC: I'll put it to you this way:

20 SM: -- from multiple --

21 GC: I turn -- I turned my head a lot. When [REDACTED] came in
22 because, A, she was still my manager.

23 SM: Uh-huh.

24 GC: Okay? She was still working for --

25 SM: Still the boss?

26 GC: She was still the boss. She never got fired. So that
27 part's, I mean, I'm in the clear on. I can't tell you. I
28 mean --

1 SM: Yeah.

2 GC: -- whatever. Do you understand?

3 SM: Yeah. But -- but as far as you know [REDACTED] didn't do
4 anything in front of you?

5 GC: As far as I know.

6 SM: Never did get -- 'cause some -- I have some people telling
7 me, some customers that said they would come in and [REDACTED]
8 would be working the register. They would get protein or
9 pills or, you know, whatever they were going to get. And
10 then he would tell them, hey, it's a special deal today.
11 If you pay with cash they would give him a -- like --like
12 they would present a credit card. He would say, if you pay
13 cash I'll give it to you for half off. Or I'll give it to
14 you for twenty-five percent off. So, or he would say if --
15 like, let's say the -- the jug is thirty bucks, he'd say,
16 if you give me a twenty dollar bill, you can have it for
17 twenty dollars and -- today only. So then they would pay
18 -- they would pay him cash, he would take the money and
19 never ring it up in the -- in the register.

20 GC: I -- that I never saw. On that, on [REDACTED].

21 SM: Does that surprise you though if someone -- if I was to say
22 somebody, well, two witnesses in particular said that?

23 GC: It would kind of surprise me. (INAUDIBLE). I --

24 SM: (INAUDIBLE) think that was my phone (INAUDIBLE).

25 GC: I -- well, that thing I didn't know about his record. But
26 I think most of it had to do with the lady and had to do
27 with that -- that morning. 'Cause I called [REDACTED] right
28 there, right after they left. I said look, everything's

1 being thrown down into the box, nothing was scanned. Well,
2 there was a few things that were scanned, yes. Yes, there
3 were things that were being scanned but then there were
4 other things --

5 SM: Do you -- do you know if things thrown into the box were
6 expired items?

7 GC: No. Because we didn't need to have like three things of
8 water. That didn't expire. Did -- do -- do you know what
9 I mean?

10 SM: Yeah. So -- so, no, they weren't --

11 GC: That they were taken in the back.

12 SM: -- expired? Right.

13 GC: They were some, yes. 'Cause we -- we -- I'll put to you
14 this way: We -- they'd have crap load of expired product.
15 I mean, we had a lot of expired product.

16 SM: How often did you guys get rid of expired product?

17 GC: Not at --

18 SM: I mean, it's like a monthly thing?

19 GC: (INAUDIBLE) it would be expired. Pretty much but the time
20 it was being expired, like when her -- when she left,
21 [REDACTED] and I didn't do anything. Didn't do any work. We
22 just did what we usually do. That's it. We didn't go the
23 extra mile. Do -- do you know what I mean?

24 SM: Uh-huh. Yeah.

25 GC: On that.

26 SM: Sure. So -- so give me a time frame. You guys, or Shane
27 did his inventory when? You know what --

28 GC: That's what (INAUDIBLE).

1 SM: -- what month?
2 GC: August maybe. It was way before Ito came and it was after
3 [REDACTED] left.
4 SM: Well, when did [REDACTED] leave?
5 GC: Her -- she called me up and was pissed on July 29th.
6 SM: Okay and then --
7 GC: That -- that the things (INAUDIBLE). So --
8 SM: Is that the day she quit?
9 GC: No.
10 SM: Had she been fired? Or how --
11 GC: No, her -- her -- no, she never got fired.
12 SM: Oh, that was the day her medical ran out?
13 GC: Right. Her medical.
14 SM: And so she left after that?
15 GC: No. No. She left --
16 SM: When did she --
17 GC: (INAUDIBLE) so she can get the medical. Do, do you
18 understand?
19 SM: Yeah. I'm trying. Yeah, I'm trying.
20 GC: You know what I mean? Like from here, let's say, I, you
21 know, I don't know the specific dates. I'm not trying to
22 hint around.
23 SM: Uh-huh.
24 GC: But if she left July 4th and let's say July 6th was her
25 medical, or her operation, then let's say July 29th she
26 gets a letter saying that she owes money because her
27 medical got cut on July 29th.
28 SM: Right. So then she's pissed off.

1 GC: Right. But -- but -- but that's the time frame. Do you
2 know what I mean? But Shane I think did that before that
3 happened.

4 SM: He did his inventory before that happened?

5 GC: Before that happened. I believe -- I think so if I could
6 remember.

7 SM: All right. All right.

8 GC: Do -- do you understand what I'm getting at?

9 SM: I'm trying. I'm trying really hard. But the --

10 GC: I never saw (INAUDIBLE).

11 SM: -- the problem I'm having is I understand what you're
12 saying, but none of it adds up to eleven thousand bucks.

13 GC: Right. That's what I'm saying. Dude, that's why I'm --

14 SM: Even if -- if even you were to add what the witnesses told
15 me what --

16 GC: Okay. Before -- before you get -- before you get -- before
17 -- if something expires, I -- now I've never dealt with
18 this. But this is what I'm pretty sure of, okay? When
19 something expires you're supposed to scan it and expire it.
20 You don't throw it away. A lot of things got thrown away.

21 SM: What, before being scanned?

22 GC: Yeah. We had a -- we (INAUDIBLE) I'll put it to you this
23 way: Probably forty percent of our stuff had expired.

24 SM: Wow.

25 GC: Yeah. Because of the -- [REDACTED] and I --

26 SM: So -- so how many times --

27 GC: (INAUDIBLE).

28 SM: -- do you think that you guys got rid of expired stuff over

1 the course of your entire employment?

2 GC: Him -- him and I never did.

3 SM: Oh.

4 GC: Our managers did. That's what I'm getting at.

5 SM: Okay.

6 GC: We never knew how to and we didn't want to --

7 SM: All right.

8 GC: -- know how.

9 SM: So your -- you and [REDACTED], your job was just to come in --

10 GC: Come in.

11 SM: -- man the cash register, help the customers.

12 GC: Sell the customers -- right, exactly.

13 SM: And that's it?

14 GC: Sell the product.

15 SM: And that's it?

16 GC: And then that was it.

17 SM: All right. All right. All right.

18 GC: But I don't -- that's the -- that's why the eleven thousand

19 dollars are gone. Most of it I think was because of that

20 day that [REDACTED] came in. And I'm not saying he stole

21 anything. I mean, I don't like the guy. I'll be honest

22 with you, you know.

23 SM: Uh-huh.

24 GC: Because he never helped me at all. Because he put me by

25 myself for two months.

26 SM: Hmm.

27 GC: But, and I know that looks weird. I know it does. You

28 know?

1 SM: Well --

2 GC: And I -- I know that it looks really bad. But I don't -- I

3 mean, he did take the things out of the back but I'm

4 assuming that he transferred it to another store or

5 whatever. I mean, there were few times where he had said

6 to like Nancy or somebody, hey, you need this at your

7 store. Do this. Do -- do you know what I mean?

8 SM: Uh-huh. Yeah. No, I understand. They transfer product

9 back and forth if they needed it.

10 GC: But that's the thing, they didn't transfer anything.

11 Everything was just thrown in a box.

12 SM: That's what I mean.

13 GC: Half thrown in a box. There's nothing scanned.

14 SM: It was put in a box but nothing was scanned.

15 GC: Right, right. Like there were stuff being scanned, yes.

16 SM: But not everything.

17 GC: But not everything. That's where eleven thousand -- dude,

18 do you know -- you're telling me [REDACTED] and I would have --

19 if -- eleven thousand dollars --

20 SM: I'm asking. I'm asking. I'm not telling you that you did

21 it.

22 GC: No.

23 SM: Obviously, I --

24 GC: No, no, no. I understand. But what I'm saying, there's no

25 way for two months, I mean, that's -- how -- if we did

26 eleven thousand, that'd be half that store would have been

27 just missing. I mean, how --

28 SM: That's a lot.

1 GC: I mean, you'd see half a store.

2 SM: How much is kept in the back normally? Like, you know, you
3 have your stock in the -- in the --

4 GC: See, that's what I'm saying.

5 SM: -- display area.

6 GC: Before [REDACTED] came there was a crap load of stuff.

7 SM: Uh-huh.

8 GC: I mean, it was a mess. That's why he was pissed. It was
9 just a huge mess.

10 SM: And Shane kind of cleaned it out when he did his inventory?

11 GC: Yeah. And [REDACTED] kept it clean too.

12 SM: All right. Will you do me a favor? Don't talk to [REDACTED]
13 and don't talk to anybody else.

14 GC: I won't.

15 SM: In fact, don't even tell them that we talked.

16 GC: No. No, I won't. I promise you I won't.

17 SM: That would be -- that would be ideal for me.

18 GC: I promise you I won't.

19 SM: Okay. Thanks, [REDACTED].

20 GC: I will tell you --

21 AC: (INAUDIBLE) sheriff. I heard you guys are sheriffs.

22 SM: Huh?

23 AC: (INAUDIBLE) arrest me or what?

24 SM: What are you talking about?

25 AC: (INAUDIBLE).

26 SM: Who's he?

27 AC: (INAUDIBLE).

28 GC: I don't know. I don't know him. I just stopped by to see

1 my brother. That was it.

2 SM: All right.

3 GC: Anyway, but I -- I promise you I --

4 SM: Right.

5 GC: I don't know. (INAUDIBLE).

6 SM: All right. See ya.

7 AC: (INAUDIBLE).

8 SM: Stop. Stop. Stop. Stop. Stop. Stop.

9 (Tires squealing)

10 SM: Stop. Stop. Stop. Stop. Stop. Stop. Stop. Stop.

11 Stop.

12 (GUNFIRE, HISSING SOUND)

13 SM: Stop.

14 (GUNFIRE)

15 SM: Stop

16 AC: I'm hit.

17 SM: Stop.

18 AC: I'm (INAUDIBLE) hit, man.

19 SM: Stop.

20 AC: (INAUDIBLE) I'm hit. (INAUDIBLE).

21 SM: [REDACTED], go call 911. Stop. Sheriff's department, stop.

22 AC: I can't. I'm --

23 SM: Stop.

24 AC: I'm down.

25 SM: Stop.

26 AC: (INAUDIBLE - SCREAMING).

27 SM: Get out of the truck.

28 AC: I can't.

1 SM: Do not move.

2 AC: I can't, man.

3 SM: Do not move.

4 AC: Okay. That's it. (INAUDIBLE) man.

5 SM: Where are you hit?

6 AC: My chest, dude. (INAUDIBLE). I gotta - I gotta let go of
7 the break right now, man.

8 SM: Put the car in park.

9 AC: I can't.

10 SM: Put the car in park. What is your name? Matthews. You
11 there? Hey, dude, I'm over at [REDACTED] Shots fired.
12 I need Code 3 backup right now. This is Matthews and I got
13 a suspect in the vehicle still. He's hit in the chest.
14 What is your name? What is your name? Do not move. Do
15 not move. Do not move. Do not move.

16 AC: (INAUDIBLE).

17 SM: Stay with me. What's your name? What's your name? Stay
18 with me. Hey, [REDACTED]. [REDACTED], get over here. Stay
19 here. What's your name? What's your name? Stay here.
20 Stay here. Stay here. Stay here. Stay here.

21 AC: (INAUDIBLE).

22 SM: Stay here.

23 MV: Hey, hey.

24 SM: Hey, what's your name?

25 MV: I just got here now.

26 SM: Are you his friend?

27 MV: (INAUDIBLE).

28 SM: Okay. Can you do me a favor? Can you go stand over with

1 ██████████, stand right by that white car. Right by that
2 white car, right there. Thank you. ██████████, can you run
3 down and get those guys? Stay here. Stay here. Got
4 medical assistance on its way.

5 AC: (INAUDIBLE).

6 SM: Medical assistance is on its way. What's your name?
7 What's your name? What's your name? What's your name?
8 What's your name? Stay here. Stay here.

9 LN: What do you need? What do you need?

10 SM: Huh? I need medical is what I need. And I need gloves and
11 I need a first aid kit.

12 KH: Shawn, do we have any outstanding?

13 SM: Back up, back up. No, this is the only guy. Back up.
14 Sir, go stand over there.

15 KH: Back up out of the street, please.

16 MV: I -- I'm the manager.

17 KH: That's fine. Stand back there.

18 SM: He's still breathing but I need him -- I need some medical.

19 KH: Okay. Do we have a pulse? Do we need CPR?

20 SM: Huh? No. No CPR yet. He's still breathing. Still got a
21 pulse.

22 KH: Okay. Pressure dressing?

23 SM: We need pressure dressing. We need some gloves.

24 KH: I got gloves right here.

25 SM: I need scissors. Anybody got scissors or a knife?

26 LN: I got a knife.

27 KH: Shane, are you okay?

28 SM: Yeah, I'm fine.

1 KH: Okay. Is there anybody outstanding?
2 SM: No, he was the only guy.
3 LN: What do you got? Right there. What do you need?
4 KH: Hey, let's go (INAUDIBLE).
5 SM: Cut his clothes off, his shirt.
6 KH: (INAUDIBLE). Get everybody back.
7 SM: Cut -- if you could cut up the side, his, I don't know
8 what's in his pockets, I haven't searched him. There's a
9 crank pipe in there. I don't -- I just trying to get ID.
10 KH: Okay, hold on. I have a knife right -- I have a knife
11 right here, Shane. Is that evidence?
12 SM: Huh?
13 KH: Oh no, that was Laura's, never mind.
14 LN: That's mine.
15 SM: Yeah.
16 MB: I've got -- I've got a --
17 SM: Keep the light shining here.
18 MB: I've got a trauma shears here.
19 SM: Okay.
20 MB: I got trauma shears.
21 SM: Okay.
22 LN: Trauma shears (INAUDIBLE) right here.
23 SM: Cut -- cut them off the -- the side here. He's hit right
24 dead center in -- center punched him.
25 KH: We're with Matthews. There are no subjects outstanding at
26 this time.
27 SM: Stay here. Stay here.
28 LN: (INAUDIBLE).

1 SM: Stay here. Yeah, that's this?
2 LN: Say, "Yes".
3 SM: I don't even know who this guy is.
4 MB: (INAUDIBLE)
5 LN: (INAUDIBLE). We need it all the way -- all the way off.
6 All right?
7 SM: Stay here. Stay here, stay here.
8 MB: Stay with us, dude. Stay with us.
9 SM: Still got a pulse, still got a pulse, still got a pulse.
10 LN: Keep his head tilted back so he has an open airway.
11 SM: He's got it. He's got it.
12 LN: Well --
13 SM: I don't even know where he's hit. There it is.
14 LN: Single.
15 SM: Okay. Single. I fired four times just so you guys know.
16 LN: Okay.
17 MB: Okay.
18 SM: There was a bullet on the floor right here.
19 MB: Where's your weapon?
20 SM: It's in my holster.
21 KH: Okay. Do you need me to check down range for any other, or
22 do we have a good backstop, Shane?
23 SM: Huh? There's -- they're all into the truck. He tried to
24 run me over over here. And --
25 MV: Okay. Okay.
26 SM: Still got a pulse. Stay here.
27 MB: Stay here, dude. Stay here.
28 SM: You're okay. Keep breathing. Keep breathing. You guys

1 have a -- that little mask?

2 KH: Yeah. You have any other gloves? You need CPR, I'll do

3 compressions.

4 MB: Here.

5 LN: Toss it out.

6 MB: What's that? Okay. Ready?

7 SM: I don't want to do CPR, just to assist his breathing if he

8 needs it.

9 MB: No. He's doing all right.

10 LN: You're doing good, brother. Hang in there.

11 SM: There we go.

12 LN: Very good.

13 MB: Is it there, thread -- thread it?

14 LN: No, he's got nothing. No radial pulse at all.

15 SM: He's got a carotid.

16 MB: Yeah.

17 LN: That's good. That means (INAUDIBLE).

18 MB: Uh-huh.

19 FV: We're good.

20 MB: You know what?

21 SM: I don't even know who this guys is. Can you guys start --

22 one of you run the plate and look for some ID or something?

23 LN: Yeah.

24 KH: Where's -- do you want to do it in your car, Laura?

25 LN: Yeah, I'll run the plate. There's three holes right here

26 (INAUDIBLE).

27 MB: You know what? Keith? Keith?

28 KH: What's up?

1 MB: Let me do this. Just take him.
2 KH: Okay.
3 MB: Okay. Let me -- let me take care of this just --
4 KH: Okay.
5 MB: -- just relax and just so- -- just kind of -- if you know
6 what I mean? Just stand away (INAUDIBLE). What's -- we
7 don't have a name or anything?
8 KH: Fire's here.
9 SM: I have nothing.
10 MB: Okay.
11 SM: I don't know who the guy is.
12 MB: All right, buddy.
13 PF: (INAUDIBLE) real quick where -- where were you when --
14 SM: The crime scene needs to go from -- needs to go straight
15 across to that tree.
16 PF: Okay.
17 SM: And then it needs to go up to the building.
18 PF: Okay.
19 SM: It happened right in here.
20 PF: Oh, okay.
21 SM: He was in that parking spot next to the blue car.
22 PF: Okay.
23 SM: So he just rolled forward.
24 PF: Can you do me a favor? Can you take the tape and run it
25 that (INAUDIBLE).
26 SM: No, I'll help -- no, I'll do it with you. I'll stay with
27 you.
28 PF: Okay. You all right, brother?

1 SM: Yeah, I'm fine. This whole thing is stupid.

2 KH: Don't worry about it. You're all right. We only care
3 about you right now.

4 KH: Hey, guys, I need you to step back.

5 SM: Hey, [REDACTED], these guys are going to need to talk to you
6 in a little bit, okay? If you want to hang out in your
7 apartment. Huh?

8 CC: I got to get going (INAUDIBLE). I understand that but we
9 just had a major incident (INAUDIBLE).

10 SM: You saw -- [REDACTED], you saw everything that happened. You
11 need to tell these guys exactly what you saw.

12 KH: Hey, how far back (INAUDIBLE).

13 SM: [REDACTED], the guy in the red shirt?

14 MV: Did you get his name and ID? I'm going to throw it over to
15 you.

16 SM: Yeah. Well, that's the one he was --

17 LN: Adrian Canley.

18 SM: Okay.

19 LN: (INAUDIBLE).

20 SM: Can you -- can you run him?

21 LN: Yeah.

22 SM: He said wasn't going to -- he wasn't going to be taken
23 alive.

24 KH: Wait 'til -- wait 'til --

25 SM: I know, I know, I know.

26 MV: Don't make any more statements.

27 SM: I just don't want you guys to --

28 MV: I know. Dude, I don't doubt you at all. I know you, okay?

1 Just don't make any more (INAUDIBLE) you know. Nobody has
2 any lack of confidence in you, Shane, okay?

3 SM: I know.

4 MV: Where do you think that we need to end this (INAUDIBLE)
5 thing.

6 SM: It can start -- stop here and then we'll run it across to
7 --

8 MV: Okay. I'm going to need another roll.

9 GC: (INAUDIBLE)

10 SM: I'll go get it. Just talk with this officer and then --
11 and then they'll re-contact you later.

12 GC: Oh, no. That's fine. My car's right there.

13 SM: And you saw everything that happened?

14 GC: Yeah.

15 SM: Okay. You saw everything that happened.

16 MV: You want to sit down?

17 SM: No. I'm -- I'll stay --

18 MV: You need to stay moving?

19 SM: I'll walk -- I'll walk with you, yeah. Just need to call
20 my wife real quick.

21 MV: Hey, guys.

22 SM: Hey, what's up?

23 MV: (INAUDIBLE) alley right off to these guys right here for a
24 second.

25 KH: We don't have an alley light on this corner. We're not
26 going to be able to bring one in. Walk with me
27 (INAUDIBLE).

28 SM: [REDACTED], are you there? Hey, it's me. Just real quick,

1 okay. I was just involved in a shooting. And I'm okay.
2 But I'm not going to come home for a little while. Okay?
3 Only -- only the suspect was shot. By me. Okay? I will
4 give you an update in just a little bit. Okay, bye.
5 That's --
6 KH: You call on your wife and let her --
7 SM: -- that's funny.
8 KH: -- know you're okay?
9 SM: Yeah. I just told her -- well, you heard what I said.
10 KH: Yeah. Only the minimum. You haven't tac-loaded or
11 anything?
12 SM: Nothing. I -- I -- I de-cocked and holstered and I pulled
13 him out of the van.
14 KH: Okay.
15 SM: Or the truck. That's all I've done.
16 KH: Okay. Shit, dude, you scared the hell out of me.
17 SM: I'm so- -- dude, I -- I didn't have my ra- -- I didn't have
18 a radio. I told dispatch I was here.
19 KH: Well, all they said --
20 SM: So --
21 KH: -- Shane Matthews was involved I was like, oh fuck. You
22 know --
23 SM: I -- I told -- I told the guy I was interviewing to call
24 911.
25 KH: I don't give a shit about him. We don't --
26 SM: Yeah.
27 KH: -- know -- you know, if they didn't put it out if you were
28 shot or --

1 SM: He called -- I called 041 was the only unit that was
2 responding. Or that would respond to the Nextel and I just
3 told Ferruzza I was just in a shooting, I need Code 3
4 backup and I told him where I was and I hung up. That was
5 it.

6 KH: Why don't we hang out over here away from it until we have
7 (INAUDIBLE).

8 SM: Yeah.

9 KH: Or we can hang out in back on the other side in one of the
10 units.

11 SM: She's probably on my shell casings.

12 MV: That's going to -- that's going to be -- you okay, bro?

13 SM: Yeah, I'm fine.

14 MV: All right?

15 SM: Totally fine.

16 MV: Do you want me to give you a ride back or do you want --

17 MV: You okay, man?

18 SM: Yeah, I'm totally fine. Tell you guys the story but --

19 MV: Just so you know --

20 SM: -- happened --

21 KH: -- was there anybody besides him that needs to be
22 interviewed, Shane? That was around?

23 SM: No. He saw the whole thing. The only other guy is this
24 little -- little Hispanic guy. I don't know where he went.

25 KH: Did you (INAUDIBLE).

26 SM: He was with [REDACTED] and I told him to stay with [REDACTED].
27 He tried to come over and help. And I told him to get
28 back.

1 KH: [REDACTED] know him?
2 SM: You can ask him.
3 MV: (INAUDIBLE) this guy. Where's your car at?
4 SM: Right there with the door open.
5 PF: You need anything? Bottle of water or anything like that?
6 SM: No. The whole -- that whole thing went down really fast.
7 And --
8 PF: They always do.
9 SM: You were the only person that answered. It was --
10 PF: Yeah, yeah.
11 SM: -- were you when I called?
12 PF: Oh, yeah. Oh, yeah.
13 SM: I tried --
14 PF: That's why I put it out.
15 SM: I tried - I tried 9G, 9D, 9- -- 9J.
16 PF: Yeah. I thought you were choking at first. I really did.
17 SM: No, dude. No, I told that guy, I told [REDACTED], that's the
18 guy I was interviewing, I told him go call 911 'cause I
19 can't get ahold of anybody. So he called 911 on his cell
20 phone and then I finally got ahold of you and I didn't have
21 much time to say anything. I don't even know (INAUDIBLE).
22 PF: (INAUDIBLE).
23 SM: I'll wait. I'm sorry.
24 PF: Yeah, don't -- don't (INAUDIBLE).
25 MV: Is there -- is there anywhere we need to go to -
26 SM: The whole thing happened right here.
27 MV: No, I mean, as far as like --
28 SM: So I mean --

1 MV: -- witnesses or anybody else that we need to contact?

2 SM: There was only two -- two people out that I know of. You
3 might want to canvass and find out but I only saw two
4 people. The guy I was interviewing and then the -- the
5 other little Hispanic guy that walked up on me.

6 MV: You don't know where that guy went though?

7 SM: I don't know where he went. I don't.

8 MV: What'd he look like?

9 SM: Hispanic, 5'6, real thin, one forty. Long hair. Nobody's
10 outstanding, just the witness, that's all.

11 MV: Okay.

12 SM: Long hair, no shirt, white shorts. Barefoot. No facial
13 hair. Twenty years old maybe.

14 MV: Is that who we're looking for as another witness?

15 SM: He's a witness. I don't even know if he saw the shooting.
16 I just know that he -- he -- he came over as soon as I
17 pulled the guy out of the truck, he came over and said
18 what's going on. And I said do you know this guy and he
19 goes, no, I don't know him. And I told him -- go stand
20 over there with that guy.

21 LN: This is all the info that I got on him. He doesn't --
22 doesn't come back on probation or anything. Adrian Doyle
23 Canley out of Port Hueneme. License valid (INAUDIBLE).

24 SM: I don't even know if that's the right guy.

25 FV: Yeah, it may not be.

26 PF: I'll go looking for this guy. I'm going to call the watch
27 commander right now.

28 MV: Okay (INAUDIBLE).

1 MV: You okay, Shane?
2 SM: Yeah, totally fine.
3 MV: You want to sit down someplace?
4 SM: Nah.
5 MV: You sure?
6 SM: Yeah.
7 MV: Look, my car is over there if you want to go sit down in
8 it, just take a break.
9 SM: I just hope he doesn't die.
10 MV: Huh?
11 SM: I said I hope he doesn't die.
12 MV: (INAUDIBLE).
13 SM: As much as I didn't like what happened, I hope he doesn't
14 die.
15 MV: What do you need from us?
16 MV: You want to go kick it in the -- in my unit, get away?
17 SM: No, I'll stay. I'll stay and watch.
18 MV: You sure?
19 MV: It's okay. Yeah, I'm -- I'm sure. I'm sure.
20 MV: What do you need?
21 MV: Ferruzza's on the -- he has the cell phone, he's getting
22 the watch commander, getting major crimes rolling and stuff
23 like that.
24 MV: Okay.
25 MV: Get BI out here.
26 MV: Okay.
27 MV: I'm sure Captain's going to be enroute here as well.
28 MV: Okay.

1 MV: We're going to take and set off the parking lot.
2 MV: Okay.
3 MV: So there's no one else pulling in. I don't know if that's
4 been done.
5 CP: Who's the scribe right now?
6 MV: (INAUDIBLE).
7 MV: Right now --
8 CP: Who's doing all -- who's keeping track everybody that's in
9 here?
10 SM: Nobody.
11 MV: (INAUDIBLE).
12 MV: Okay.
13 CP: (INAUDIBLE) you're in charge of that right now.
14 MV: All right.
15 CP: Okay? Grab something real quick, notebook, anything. I'll
16 get you something in a minute (INAUDIBLE).
17 PF: I'm going to stay -- I'm going to stay with Matthews.
18 SM: Yeah. Do you mind if Paul stays with me, Sarge?
19 CP: Who's over here? We got more --
20 SM: Gram- -- Grambling's over there.
21 PF: We got Buschow over there.
22 SM: And Buschow.
23 PF: We got Grambling here interviewing witnesses. And then we
24 got Hall over there and so is (INAUDIBLE).
25 MV: You all right?
26 SM: You know how you always second-guess sometimes, you
27 second-guess yourself.
28 PF: Well, don't -- don't do it, man.

1 SM: I know, I know.

2 PF: Don't do it. Why don't we go over to my car?

3 SM: Yeah.

4 PF: Let me get the shit off the seat, okay?

5 SM: Okay. You know what? Hey, Paul, it's okay. Just leave
6 it. I -- I want to watch and see what they do with this
7 guy.

8 PF: Okay.

9 SM: If that's all right with you.

10 PF: All right. That's fine.

11 SM: I'm just -- probably better if I just stand there and watch
12 instead of sit and think, you know?

13 PF: That's fine.

14 SM: Keep -- keep my brain occupied for a little bit.

15 PF: Right. Still need to get it off here in case they want me
16 to give you a ride back to the station or something.
17 (INAUDIBLE).

18 SM: It's amazing how you don't even hear those gunshots though.

19 PF: Oh, I'm sure.

20 SM: Paul -

21

22

23

24

25

26

27

28

4 CODE	5 ITEM	6 QTY.	7 ITEM NAME	8 BRAND / MAKE MANUFACTURER	9 MODEL NAME OR NUMBER	10 MISC. DESCRIPTION	11 IDENTIFICATION / SERIAL NUMBER	12 VALUE
--------	--------	--------	-------------	-----------------------------	------------------------	----------------------	-----------------------------------	----------

Supplemental Case Cleared

Gang Domestic Hate Child Abuse Elderly Abuse

Connecting Report Numbers:

Code Section / Description: Officer Involved Shooting

Reclassify To:

Code: P **Name:** Canley, Adrian

Incident Scene Report

On 11/14/06, at about 1835 hours, I received a telephone call from Captain Kelley, who requested that I respond to assist with the investigation of an officer-involved shooting at [REDACTED] Thousand Oaks. I responded to the incident scene from the Ventura Major Crimes' Office, and I arrived at the scene at about 1920 hours.

When I arrived on scene, I noted numerous emergency services resources already deployed, including numerous sheriff's personnel and Ventura County Fire Department personnel. I also noted that crime scene tape marked off an outer perimeter, and that an inner perimeter surrounding the incident scene had also been cordoned off with crime scene tape. There were no personnel inside the inner perimeter scene when I arrived.

I met with my partner, Detective Rob Davidson, who had arrived before me. Detective Davidson briefed me on the circumstances surrounding the shooting, and, in summary, told me the following. Senior Deputy Shane Matthews was working as a plain-clothes property crimes detective, and he went to the apartments at [REDACTED] to interview a witness in a grand theft investigation. During his interview with the witness, a man, who was later identified as Adrian Canley, approached Matthews and initiated a confrontation. As the confrontation unfolded, Canley got into a white Ford pickup and drove toward Matthews. Matthews then reportedly fired several shots from his service pistol at Canley, striking Canley at least once in the upper chest. Canley was administered first aid at the scene, and he was transported to the

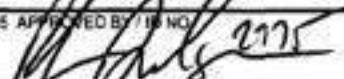
13 DATE / TIME OF REPORT 01/30/07 / 10:51 AM	14 REPORTING OFFICER / ID NO / DIV / UNIT Sgt. W. Ayub/#3318/Special Services SA	15 APPROVED BY / ID NO. 
---	---	--

NARRATIVE REPORT VENTURA COUNTY SHERIFF'S DEPARTMENT

Page 2 of 6

Continuation

AGENCY IDENTIFIER CA0560000

1 RD 9072	2 BEAT 9G01	3 RB NUMBER 06-30492
--------------	----------------	-------------------------

4 CODE	5 ITEM	6 QTY.	7 ITEM NAME	8 BRAND / MAKE MANUFACTURER	9 MODEL NAME OR NUMBER	10 MISC. DESCRIPTION	11 IDENTIFICATION / SERIAL NUMBER	12 VALUE
--------	--------	--------	-------------	-----------------------------	------------------------	----------------------	-----------------------------------	----------

Los Robles Regional Medical Center where he died from his wounds. As we spoke, Detective Davidson pointed out various features inside the inner perimeter scene, including a white Ford F-150 pickup, several expended pistol cartridges, clothing, and first aid supplies.

I noted the property at [REDACTED] consists of (2) two-story apartment buildings, a community center building, and numerous covered carports with an open parking area. The property to the west of [REDACTED] which has an address of [REDACTED] [REDACTED] has a three story senior citizen complex that overlooks the parking area where this incident occurred. The property east of [REDACTED] is mostly undeveloped with some low-lying residential structures.

The complex at [REDACTED] is known as [REDACTED] and it is accessed off of Los Feliz Drive. As one enters the complex, there is a long asphalt driveway that extends approximately 350 feet toward the south end of the property. On the east side of the driveway, just past the property entrance, is a two-story apartment building containing apartments [REDACTED] and [REDACTED] and there are covered carports along the west side of the driveway. There is a community center building with an outdoor pool on the east side of the property, just south of the aforementioned apartment building.

In the center of the driveway, past the first apartment building and the community center building, is a large circular planter containing a tree. This planter and tree serve as a traffic round, and the driveway continues around and past the planter. There are two opposing sets of covered carports just south of the planter, and there is a U-shaped two-story apartment building just south of the covered carports. The U-shaped apartment building contains apartments [REDACTED] [REDACTED] To the east of the opposing carports is a small parking lot, which is where this incident unfolded.

The parking lot is paved with asphalt and it is accessed off of the traffic round (just east of the large circular planter with the tree). The access way into the parking lot is at the northwest corner of the parking lot. The parking lot is rectangular in shape and measures approximately 100 feet in length (north to south) and approximately 66 feet in width (east to west). The north side of the parking lot is enclosed with a concrete curb, planter, sidewalk, and the community center building. The east side of the parking lot is enclosed with a concrete

13 DATE / TIME OF REPORT
01/30/07/ 10:51 AM

14 REPORTING OFFICER / ID NO / DIV / UNIT
Sgt. W. Ayub/#3318/Special Services BA

15 APPROVED BY / ID NO

NARRATIVE REPORT VENTURA COUNTY SHERIFF'S DEPARTMENT

Page 3 of 6

Continuation

AGENCY IDENTIFIER CA0560000

1 RD 9072	2 BEAT 9G01	3 RB NUMBER 06-30492
--------------	----------------	-------------------------

4 CODE	5 ITEM	6 QTY.	7 ITEM NAME	8 BRAND / MAKE MANUFACTURER	9 MODEL NAME OR NUMBER	10 MISC. DESCRIPTION	11 IDENTIFICATION / SERIAL NUMBER	12 VALUE
--------	--------	--------	-------------	-----------------------------	------------------------	----------------------	-----------------------------------	----------

curb, planter, and a 6-foot cinder block wall, which is capped with wrought iron fencing. The south side of the parking lot is enclosed with a concrete curb, a grassy standoff, and the north exterior wall of apartments [REDACTED]. The west side of the parking lot is enclosed with a cement curb, a grassy standoff, and the east wall of the covered carports. There are 9 parking stalls perpendicular to the west curb line and there are 11 parking stalls perpendicular to the east curb line. There is a raised cement planter on the north side of the parking stalls against the west curb line. That planter contained several thick rose bushes and a tree.

I examined the inner perimeter of the incident scene, which included the entire parking lot area described above. There were 14 vehicles parked within the parking area. All of the vehicles were within marked parking stalls with the exception of a marked black and white Thousand Oaks Police Ford Crown Victoria patrol vehicle (unit #3263) and a white Ford F-150 pickup truck, CA license [REDACTED]. The patrol unit was parked facing in an easterly direction just inside the driveway entrance to the parking lot, and the white Ford F-150 was parked facing in a northerly direction against the north curb line of the parking area. The black and white patrol unit was parked partially behind and perpendicular to the Ford F-150. Also of note was Detective Matthews' unmarked police vehicle, which was a maroon colored Chevrolet Astro van, CA license [REDACTED]. It was parked against the east curb line in the third stall south of the north curb line and, its right rear cargo door was standing open.

I examined each of the vehicles located within the incident scene and I saw no evidence that led me to believe any of the other vehicles within the parking area contained any evidence, sustained any damage, or were involved in this incident in any manner. For specific details of the other vehicles parked within the scene, refer to Senior Deputy Godfrey's supplemental report and/or the incident scene images.

As I walked around the perimeter of the incident scene, I saw a small notebook and a compact disc with a Sheriff's Department label lying on the grassy area on the west side of the parking area between the sidewalk and the east wall of the carports. I later learned that the notebook and disc belonged to Detective Matthews and he dropped them on the grass as the confrontation between he and Canley unfolded.

13 DATE / TIME OF REPORT 01/30/07/ 10:51 AM	14 REPORTING OFFICER / ID NO / DIV / UNIT Sgt. W. Ayub/#3318/Special Services BA	15 APPROVED BY / ID NO 
--	---	---

NARRATIVE REPORT VENTURA COUNTY SHERIFF'S DEPARTMENT

Page 4 of 6

Continuation

AGENCY IDENTIFIER CA0560000

1 RD 9072	2 BEAT 9G01	3 RB NUMBER 06-30492
--------------	----------------	-------------------------

4 CODE	5 ITEM	6 QTY.	7 ITEM NAME	8 BRAND / MAKE MANUFACTURER	9 MODEL NAME OR NUMBER	10 MISC. DESCRIPTION	11 IDENTIFICATION / SERIAL NUMBER	12 VALUE
--------	--------	--------	-------------	-----------------------------	------------------------	----------------------	-----------------------------------	----------

I continued examining the incident scene, and I found a pair of acceleration scuffmarks in the third parking stall south of the parking area entrance, on the west side of the parking lot. Each of the scuffmarks were approximately 3 feet in length and appeared to have been freshly created based on the black powdery rubber residue I could see on the surface of the scuffmarks. The scuffmarks were in such a position within the stall that they appeared to have been made by the rapid acceleration of the rear wheels of a vehicle that was parked nose in (or the front wheels of a vehicle that was backed into the stall). Senior Deputy Godfrey, who responded to the scene to prepare a factual diagram, measured the scuffmarks and found them to be approximately the same size as the exterior wheelbase of the rear tires on the Ford F-150 pickup. I found no other fresh acceleration or deceleration scuffmarks on the parking lot.

I noted four expended silver colored .40 caliber Speer cartridge casings lying on the asphalt near the southern most portion of the entrance to the parking area. A fifth casing was found lying in the raised flowerbed that borders the southern most portion of the entrance to the parking area. All of the casings were within approximately 7 feet of each other.

In the driveway of the parking area immediately adjacent to the first parking stall south of the entrance to the parking area was a field of automotive fluid. The fluid field began at the first parking stall south of the parking area entrance and led to the underside of the engine compartment area of the Ford F-150 pickup where it pooled at the north curb line of the parking area. I could smell the distinct odor of radiator coolant emanating from the fluid field. Near the beginning of the fluid field, I noted a piece of copper bullet jacketing and a fragment of lead. I noted another piece of copper bullet jacketing under the marked police vehicle, which was parked across the fluid field. Refer to Senior Deputy Godfrey's diagram and the crime scene images for additional information.

I examined the white Ford F-150 pickup, and I noted that each of its four tires appeared to be properly inflated. I saw minor collision damage on the driver's side and front bumper of the vehicle, and miscellaneous scratches and dings on the truck body. I could see that the truck's driver's side window and passenger side window were partially rolled down. I looked into the truck from the exterior and noted the gear selector was in "D" or "drive." I could see that the ignition was in an "off" position, and I noted the vehicle keys were still in the ignition. I could

13 DATE / TIME OF REPORT
01/30/07/ 10:51 AM

14 REPORTING OFFICER / ID NO / DIV / UNIT
Sgt. W. Ayub/#3318/Special Services BA

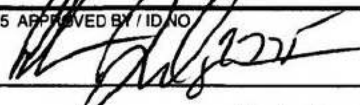
15 APPROVED BY / ID NO

NARRATIVE REPORT VENTURA COUNTY SHERIFF'S DEPARTMENT

Page 5 of 6

Continuation

AGENCY IDENTIFIER CA0560000

1 RD 9072	2 BEAT 9G01	3 RB NUMBER 06-30492
--------------	----------------	-------------------------

4 CODE	5 ITEM	6 QTY.	7 ITEM NAME	8 BRAND / MAKE MANUFACTURER	9 MODEL NAME OR NUMBER	10 MISC. DESCRIPTION	11 IDENTIFICATION / SERIAL NUMBER	12 VALUE
--------	--------	--------	-------------	-----------------------------	------------------------	----------------------	-----------------------------------	----------

also see a small folding knife wedged into the space between the driver's seat cushion and the seat back. The blade on the folding knife was open; however, it appeared to have been wedged in the seat for some time based on the amount of debris that was accumulated on top of the knife. I also noted a pair of binoculars sitting on the seat cushion of the front passenger's seat.

As I examined the Ford F-150, I noted two apparent bullet strikes on the front grill area of the truck. The first impact I noted was on the front bumper. I could see the bullet imbedded in the metal of the bumper without penetrating the metal. The second impact penetrated the truck's plastic grill and traveled through the radiator and into the engine compartment. I believe the fragments from this particular bullet were the ones I noted at the beginning of the fluid field the truck left behind. I also noted three bullet holes in the truck's windshield, directly in front of the driver's seat. I could see corresponding damage to the truck's dashboard from the bullets that passed through the windshield.

I observed several items of clothing, various emergency medical supplies, a cellular telephone, a butane lighter, knit gloves, white tennis shoes, an expended bullet, and a large caliber black handgun lying on the ground, next to the left front tire of the truck. Based on statements of witnesses I obtained, the clothing was removed from Canley during attempted life saving procedures. I also learned that the personal property was removed from Canley's person, including the black handgun, which had been found tucked in the right side waistband of Canley's pants by attending paramedics/firefighters. Much of the clothing and the handgun were soaked in radiator fluid.

Field Evidence Technician [REDACTED] responded to the incident scene and took overall digital images. He then placed photo markers on each item of evidence and took more overall digital images of the scene and of each item of evidence.

I examined the firearm that had been found on Canley's person by emergency medical personnel. I found the pistol to be manufactured by Hi-Point Firearms with a model number of JHP45ACP and a serial number of [REDACTED]. The pistol was black in color and manufactured in .45 ACP caliber. I noted that the weapon's safety was "on," meaning the thumb safety lever would have to be depressed before the weapon could be fired. I removed the magazine from

13 DATE / TIME OF REPORT
01/30/07/ 10:51 AM

14 REPORTING OFFICER / ID NO. / DIV / UNIT
Sgt. W. Ayub/#3318/Special Services BA

15 APPROVED BY / ID NO.
[Signature] 2225

NARRATIVE REPORT VENTURA COUNTY SHERIFF'S DEPARTMENT

Page 6 of 6

Continuation

AGENCY IDENTIFIER CA0560000

1 RD 9072	2 BEAT 9G01	3 RB NUMBER 06-30492
--------------	----------------	-------------------------

4 CODE	5 ITEM	6 QTY.	7 ITEM NAME	8 BRAND / MAKE MANUFACTURER	9 MODEL NAME OR NUMBER	10 MISC. DESCRIPTION	11 IDENTIFICATION / SERIAL NUMBER	12 VALUE
--------	--------	--------	-------------	-----------------------------	------------------------	----------------------	-----------------------------------	----------

the pistol and I found it to be loaded with seven .45 ACP rounds. I then opened the pistol's action and found a single .45 ACP round in the firing chamber. After clearing the weapon, I gave it to F.E.T. [REDACTED]

After taking digital images of the scene, FET Farrell collected and packaged each item of evidence. He later booked the evidence into a secure storage locker at the East County Sheriff's Station. Refer to FET [REDACTED] property report for additional information.

13 DATE / TIME OF REPORT
01/30/07/ 10:51 AM

14 REPORTING OFFICER / ID NO. / DIV / UNIT
Sgt. W. Ayub/#3318/Special Services BA

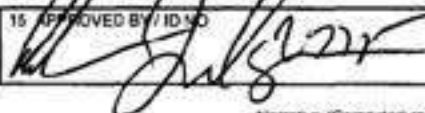
15 APPROVED BY / ID NO.



© 2007 Europa Technologies

Porter 34 10 34 CH N 118 50 41 74 W elev. 360 ft. Streamer 100 100 Elev alt. 1975 ft



© 2007 Europa Technologies

Point: 34°12'33.43" N, 118°50'42.39" W, Elev: 856 ft, Steepness: 1.14, 100%

Eye Alt: 1176 ft

NARRATIVE REPORT VENTURA COUNTY SHERIFF'S DEPARTMENT

Page 2 of 2 Continuation

AGENCY IDENTIFIER CA0560000

1 RD 9072	2 BEAT 9G01	3 RB NUMBER 06-30492
--------------	----------------	-------------------------

4 CODE	5 ITEM	6 QTY	7 ITEM NAME	8 BRAND / MAKE MANUFACTURER	9 MODEL NAME OR NUMBER	10 MISC. DESCRIPTION	11 IDENTIFICATION / SERIAL NUMBER	12 VALUE
--------	--------	-------	-------------	-----------------------------	------------------------	----------------------	-----------------------------------	----------

████████ said the man was trying to show him some sort of card in his wallet, and he specifically said the he knew what an officer's badge looks like and he did not see one.

I asked ██████████ why he believed the motorist he had the altercation with was the same individual involved in the shooting. ██████████ said the motorists' behavior was similar to what he read about the behavior of the man who was shot, and he described the man as a "nut". I asked ██████████ if he could describe the race of the man he had the altercation with, and he told me he was "American". Upon further questioning, ██████████ told me the man was "White", in his twenties, with a medium build, a slight mustache, and wearing a baseball style cap. He could not provide any further description of the man, and he did not get the license number of the man's truck. ██████████ thought he would be able to recognize the man if he saw him again.

████████ said the altercation continued while he drove west on Thousand Oaks Blvd., north on Hodencamp Rd., west on Hillcrest Dr., south on Boardwalk Ave., west on Thousand Oaks Blvd, and then north on Moorpark Rd. Once on Moorpark Rd., ██████████ accelerated and evaded the other motorist. After the altercation, ██████████ drove over to ██████████ apartments on Los Feliz Drive to visit a friend. He later learned of the shooting incident that occurred up the block on Los Feliz Drive, and he guessed it involved the same man he had the altercation with.

I concluded my conversation by thanking him for his time, and I provided him with my contact telephone number for future reference.

I recorded my conversation with ██████████ with a digital audio recording device, and I later preserved a copy of the recording on a compact disc. For additional details, refer to the digital audio recording.

13 DATE / TIME OF REPORT 12/14/06/ 12:28 PM	14 REPORTING OFFICER / ID NO / DIV / UNIT Sgt. W. Ayub/#3318/Special Services BA	15 APPROVED BY / ID NO [Signature] #7917501
--	---	--

NARRATIVE REPORT VENTURA COUNTY SHERIFF'S DEPARTMENT

Page 1 of 2 Continuation

AGENCY IDENTIFIER CA0560000

1 RD 9072	2 BEAT 9G01	3 RB NUMBER 06-30492
--------------	----------------	-------------------------

4 CODE	5 ITEM	6 QTY	7 ITEM NAME	8 BRAND / MAKE MANUFACTURER	9 MODEL NAME OR NUMBER	10 MISC. DESCRIPTION	11 IDENTIFICATION / SERIAL NUMBER	12 VALUE
--------	--------	-------	-------------	-----------------------------	------------------------	----------------------	-----------------------------------	----------

- Supplemental Case Cleared
 Gang Domestic Hate Child Abuse Elderly Abuse

Connecting Report Numbers:

Code Section / Description: Officer Involved Shooting

Reclassify To:

Code: W Name: [REDACTED]



On 11/17/06, at about 1040 hours, I telephoned [REDACTED] [REDACTED] at [REDACTED] regarding a telephone message he left with Sheriff's Dispatch concerning some information he had, which possibly related to the officer involved shooting of Adrian Canley, on 11/14/06.

I identified myself to [REDACTED] and confirmed that he telephoned the Sheriff's Department and reported an encounter with the man he believed had been shot by a deputy in Thousand Oaks. [REDACTED] confirmed that he and his wife got into a confrontation with the "same guy" earlier that day, at about 5:00 p.m. [REDACTED] continued and told me that he was driving his vehicle on "Auburn Street" near the Chevrolet dealership (Auburn Court at Thousand Oaks Boulevard, Thousand Oaks) when his vehicle was almost struck by another motorist in a black or dark gray truck. [REDACTED] said he honked and the other driver "just snapped" and stopped his truck. The other driver stopped his truck in the street and got out. As [REDACTED] drove around the stopped truck, the other motorist got back into his truck, drove in front of [REDACTED] vehicle, and began braking. During this time, the other motorist displayed a wallet and claimed to be a "cop" while telling [REDACTED] that he had a gun and was going to kill him.

13 DATE / TIME OF REPORT 12/14/06/ 12:28 PM	14 REPORTING OFFICER / ID NO / DIV / UNIT Sgt. W. Ayub/#3318/Special Services <i>BA</i>	15 APPROVED BY / ID NO <i>J. Blum #917501</i>
--	--	--

NARRATIVE REPORT VENTURA COUNTY SHERIFF'S DEPARTMENT

1 RD 9072	2 BEAT 9G01	3 RB NUMBER 2006-30492
--------------	----------------	---------------------------

Page 3 of 8 Continuation

AGENCY IDENTIFIER CA0560000

4 CODE	5 ITEM	6 QTY	7 ITEM NAME	8 BRAND / MAKE MANUFACTURER	9 MODEL NAME OR NUMBER	10 MISC. DESCRIPTION	11 IDENTIFICATION / SERIAL NUMBER	12 VALUE
--------	--------	-------	-------------	-----------------------------	------------------------	----------------------	-----------------------------------	----------

█████ stated, "Oh shit. It might be." The male then ran down and looked at the body and then ran back up to his apartment.

I asked █████ the name or a description of the male. █████ stated that he did not know the males name because only the male's parents live in the apartment and the male only comes to visit. █████ described the male as Hispanic wearing long baggy shorts and no shirt, with a ponytail. █████ also said the male stated he was sleeping.

I asked █████ further details about the male that ran down to the location of the incident. █████ said the male ran down and looked at the body and then ran back upstairs. He said the male only stayed "down there" for less than a minute. I asked █████ how close the male got to Det. Matthews. He said that he got close, probably within arms reach. █████ said he could not tell if there was any conversation between the male and Det. Matthews.

█████ further stated that his tenants have told him that they do not like the type of people that are brought around by the tenants in #█████. He stated the people "look like gang bangers."

Prior to concluding my interview with █████, he stated that Det. Matthews had come to the apartment complex about a month prior, asking for Mr. █████. █████ assumed that he was asking for █████ █████, who lives upstairs and is "the witness's" brother. On that date █████ told Det. Matthews that █████ was not home but would be home between 4:00 and 5:00 pm. █████ said that was the last time he saw Det. Matthews until "now" because █████ █████ told him that Det. Matthews was the same guy. █████ also stated that Det. Matthews came in the same van then as he did this evening.

I concluded my interview with █████.

13 DATE / TIME OF REPORT 12-04-06 / 0948	14 REPORTING OFFICER / ID NO / DIV / UNIT Det. M. Harris/#3713/East County Invest.	15 APPROVED BY / ID NO <i>[Signature]</i>
---	---	--

NARRATIVE REPORT VENTURA COUNTY SHERIFF'S DEPARTMENT

1 RD 9072	2 BEAT 9G01	3 RB NUMBER 2006-30492
--------------	----------------	---------------------------

Page 2 of 8 Continuation

AGENCY IDENTIFIER CA0560000

4 CODE	5 ITEM	6 QTY	7 ITEM NAME	8 BRAND / MAKE MANUFACTURER	9 MODEL NAME OR NUMBER	10 MISC. DESCRIPTION	11 IDENTIFICATION / SERIAL NUMBER	12 VALUE
--------	--------	-------	-------------	-----------------------------	------------------------	----------------------	-----------------------------------	----------

He was inside his apartment with his son having dinner, when heard about five or six gunshots. [REDACTED] said he did not hear any screaming or yelling prior to the gunshots. After the gunshots, [REDACTED] heard some voices but could not make out what was being said. He also could not determine if the voices were male or female. [REDACTED] then heard someone say, "Call 911" in a male voice.

I asked [REDACTED] if he ever left his apartment to see what had happened outside. He stated he ([REDACTED]) walked outside and down to the parking lot area. He saw a male, wearing a red shirt, and approached him. [REDACTED] asked the male who he was and the male responded he was [REDACTED]'s son. I then asked [REDACTED] what he saw in the parking lot area. He pointed in the area of the white truck and stated that he saw a male lying on the ground. He also said that he saw another male giving first-aid to the male on the ground.

I asked [REDACTED] for a description of the male on the ground. [REDACTED] said the male on the ground appeared Hispanic with a baldhead, wearing a dark jacket.

I asked [REDACTED] for a description of the male giving first aid. [REDACTED] stated, "He was dressed like a detective." I asked [REDACTED] what he meant. He stated, "Like you, without the jacket."

I inquired of [REDACTED] if he would be able to recognize either male if seen again or shown photographs of each. [REDACTED] said he would not be able to recognize either person.

I asked [REDACTED] if he knew the male on the ground or had seen him recently around the apartment complex. [REDACTED] said he did not know the male. I asked about the pickup truck. [REDACTED] said, "That's something, the people who live right next to me, here. # [REDACTED]. I know they had a couple of friends that came by that have a truck like that."

[REDACTED] then stated, "I asked him. When it all happened. I came out to this here and he came out. I told him, isn't that your friend's truck. Looks exactly like it." The male that exited from

13 DATE / TIME OF REPORT 12-04-06 / 0948	14 REPORTING OFFICER / ID NO / DIV / UNIT Det. M. Harris/#3713/East County Invest.	15 APPROVED BY / ID NO <i>[Signature]</i> / 2381
---	---	---

NARRATIVE REPORT VENTURA COUNTY SHERIFF'S DEPARTMENT

Page 1 of 8 Continuation

AGENCY IDENTIFIER CA0560000

1 RD 9072	2 BEAT 9G01	3 RB NUMBER 2006-30492
--------------	----------------	---------------------------

4 CODE	5 ITEM	6 QTY	7 ITEM NAME	8 BRAND / MAKE MANUFACTURER	9 MODEL NAME OR NUMBER	10 MISC. DESCRIPTION	11 IDENTIFICATION / SERIAL NUMBER	12 VALUE
--------	--------	-------	-------------	-----------------------------	------------------------	----------------------	-----------------------------------	----------

- Supplemental Case Cleared
 Gang Domestic Hate Child Abuse Elderly Abuse

Connecting Report Numbers:

Code Section / Description: 245(c) P.C.

Reclassify to:

Code: S-1 Name: Canley, Adrian



On 11/14/06, at approximately 1835 hours, I arrived at [REDACTED], Thousand Oaks, CA. I was asked by Sergeant Weaver, along with Det. Alvarez to conduct a door-to-door canvass of the apartment building to the rear of the complex, immediately south of the crime scene.

I approached and knocked on the door of apartment # [REDACTED]. I initially did not get an answer at the door and began to walk away. I was approached by a male, later identified as (W) [REDACTED], who asked if I needed to speak with the occupants of the apartment. [REDACTED] stated he was the apartment manager and could help me in speaking with the occupants. [REDACTED] began knocking on the apartment door and stating his name. A female adult female identified as [REDACTED] answered the knocks on her door. I asked if I could speak with her and the occupants of the apartment. [REDACTED] invited [REDACTED] and me inside the apartment. [REDACTED] and I stood in the living room area. [REDACTED] remained in the kitchen area of the apartment.

After speaking with [REDACTED] ([REDACTED] daughter), I spoke with [REDACTED] in the open courtyard of the apartment complex. The following is a synopsis of my digitally recorded conversation with [REDACTED]. Refer to the CD for details. I spoke with [REDACTED] and he told me the following:

13 DATE / TIME OF REPORT 12-04-06 / 0948	14 REPORTING OFFICER / ID NO. / DIV. / UNIT Det. M. Harris / #3713 / East County Invest.	15 APPROVED BY / ID NO. <i>[Signature]</i> / 2486
---	---	--

NARRATIVE REPORT VENTURA COUNTY SHERIFF'S DEPARTMENT

1 RD. 9072	2 BEAT 9G01	3 RB NUMBER 2006-30492
---------------	----------------	---------------------------

Page 4 of 4 Continuation

AGENCY IDENTIFIER CA0560000

4 CODE	5 ITEM	6 QTY	7 ITEM NAME	8 BRAND / MAKE MANUFACTURER	9 MODEL NAME OR NUMBER	10 MISC. DESCRIPTION	11 IDENTIFICATION / SERIAL NUMBER	12 VALUE
--------	--------	-------	-------------	-----------------------------	------------------------	----------------------	-----------------------------------	----------

"Yes. Cause there was some Fucking guy right there. That's when I went up and said, "What the fuck is going on?" This guy was like step over there. So I stepped back and was gone."

I asked [REDACTED] if he knew whom the truck belonged to or the identity of the guy on the ground. [REDACTED] stated, "Nah." I told [REDACTED] that everyone I spoke with indicated that the guy on the ground and the truck were associated with his apartment. He stated, "Nah. Cause what it was. What it was. There is some guy. Some friend of mine that has a truck like that. And that's why I went down there." I asked [REDACTED] the name of his friend with that truck. [REDACTED] stated, "See, you asking too much, Homie. It ain't really none of your business." I told [REDACTED] that it was my business, since I wanted to make sure the guy on the ground was not his friend. [REDACTED] stated, "Well, it's not. Like I told you." I asked him how he knew. He stated, "How do I know. Cause I went out there, Man."

I continued to speak with [REDACTED] and he continued to state that he did not know the guy on the ground.

I ended my interview with [REDACTED].

13 DATE / TIME OF REPORT 12-04-06 / 0953	14 REPORTING OFFICER / ID NO / DIV / UNIT Det. M. Harris / #3713 / East County Invest.	15 APPROVED BY / ID NO <i>[Signature]</i> / 12486
---	---	--

NARRATIVE REPORT VENTURA COUNTY SHERIFF'S DEPARTMENT

Page 3 of 4 Continuation

AGENCY IDENTIFIER CA0560000

1 RD 9072	2 BEAT 9G01	3 RB NUMBER 2006-30492
--------------	----------------	---------------------------

4 CODE	5 ITEM	6 QTY	7 ITEM NAME	8 BRAND / MAKE MANUFACTURER	9 MODEL NAME OR NUMBER	10 MISC. DESCRIPTION	11 IDENTIFICATION / SERIAL NUMBER	12 VALUE
--------	--------	-------	-------------	-----------------------------	------------------------	----------------------	-----------------------------------	----------

█████ that he did not hear anything. He stated, "Yea, I thought I heard something like that. That's what I was thinking. Um. They told me it was fucking gunshots. So I'm like what the fuck."

I asked █████ if he ever went outside after hearing the gunshots. █████ stated, "Nah." I stated, "Never." He stated, "I did. I stepped out right here. I peaked it out and after that I went back inside." I clarified with █████ that he stepped outside on the patio, to the front of his apartment. He stated, "Yea. After that I just went back in."

I then asked █████ if he ever went downstairs to see what was going on. █████ stated, "Yea I did. (inaudible)." I asked █████ if he went further than the patio. He stated, "I came down there." I asked if he went down to the grass area. He stated, "I came down there and asked the guy. What the hell was going on?" I attempted to clarify with █████, which "guy" he was referring to. █████ stated, "I don't know, I don't know him." █████ began to become upset and stated, "To tell you the truth, I ain't all with this shit. I'm straight with all this. That's why you guys are writing down all my name and shit. That shit ain't all cool right there." I explained to █████ that I was writing everyone's name down to be included in a report. █████ continued to be upset and stated, "Nah. I don't want none of my name in no report. That shits bullshit right there." I asked █████ what he meant. He stated, "You guys already know whats up man. All this report shit. That shit is all some fucking bullshit. To tell you the truth." I again asked █████ for some clarification. He stated, "You guys get some people into problems by doing this stuff right here, man. This is bullshit." I again attempted to explain to █████ that we needed to find out information about what happened.

I also explained to █████ that the more information he tells me, the quicker I will leave him alone. He stated, "I ain't got really nothing to tell you." I also told █████ that the more honest he is with me, the quicker I leave. █████ stated, "It ain't a question of being honest." I told █████ that he was not being honest with me. He stated, "How am I not being honest with you, Man." I told him that I spoke with someone, who stated that he ran down to the location of the truck. █████ became agitated and stated, "I told you, I did. I told you, I went out here. I fucking saw (inaudible)." I reiterated to █████ that he went to the location of the truck. █████ stated,

13 DATE / TIME OF REPORT 12-04-06 / 0953	14 REPORTING OFFICER / ID NO / DN / UNIT Det. M. Harris/#3713/East County Invest.	15 APPROVED BY / ID NO <i>[Signature]</i>
---	--	--

NARRATIVE REPORT VENTURA COUNTY SHERIFF'S DEPARTMENT

Page 2 of 4 Continuation

AGENCY IDENTIFIER CA0560000

1 RD 9072	2 BEAT 9G01	3 RB NUMBER 2006-30492
--------------	----------------	---------------------------

4 CODE	5 ITEM	6 QTY	7 ITEM NAME	8 BRAND / MAKE MANUFACTURER	9 MODEL NAME OR NUMBER	10 MISC. DESCRIPTION	11 IDENTIFICATION / SERIAL NUMBER	12 VALUE
--------	--------	-------	-------------	-----------------------------	------------------------	----------------------	-----------------------------------	----------

door opened, I did not see any more occupants inside the apartment. I asked [REDACTED] if we could come inside and speak with her about what she may have seen or heard, [REDACTED] invited us inside. As we walked inside to the living room area, a male, identified as [REDACTED] [REDACTED], exited out of the east bedroom wearing only a white towel around his waist. [REDACTED]'s hair was wet.

[REDACTED] immediately began asking why we were inside of his apartment and where was our warrant. I explained to [REDACTED] that we needed to speak with all the occupants of the apartment regarding the incident in the parking lot and since his mother, [REDACTED], had invited inside I did not need a warrant.

Another male and two females exited the west bedroom and entered the living room area. I asked [REDACTED] if he wanted to put some clothes on prior to speaking with me. [REDACTED] and the other male, identified as Mario [REDACTED], then entered into the bathroom between the east and west bedroom.

While [REDACTED] was changing, I spoke with [REDACTED] and she stated that she was not home and did not see or hear anything. Det. Smith and Alvarez spoke with the other occupants of the apartment, refer their reports for further details.

After speaking with [REDACTED], I spoke with [REDACTED]. The following is a summary of my digitally recorded conversation; refer to CD for further details.

I walked into the west bedroom and knocked on the open door. I entered the room to speak with [REDACTED]. I asked [REDACTED] what happened. He stated, "I don't know. I was just right here and heard gunshots. That was all."

I asked [REDACTED], how many gunshots he heard. He stated, "I don't know. I'm not sure, I was kinda asleep." I began asking if he heard 15, 20 or 25. [REDACTED] stated, "Nah, I don't know. To tell you the truth, I heard like Pow and thought it was the stairs or something." I again asked [REDACTED] how many he heard. He stated, "I didn't really hear none of it." I tried to clarify with

13 DATE / TIME OF REPORT 12-04-06 / 0953	14 REPORTING OFFICER / ID NO / DIV / UNIT Det. M. Harris/#3713/East County Invest.	15 APPROVED BY / ID NO <i>[Signature]</i>
---	---	--

NARRATIVE REPORT VENTURA COUNTY SHERIFF'S DEPARTMENT

1 RD 9072	2 BEAT 9G01	3 RB NUMBER 2006-30492
--------------	----------------	---------------------------

Page 1 of 04 Continuation

AGENCY IDENTIFIER CA0560000

4 CODE	5 ITEM	6 QTY	7 ITEM NAME	8 BRAND / MAKE MANUFACTURER	9 MODEL NAME OR NUMBER	10 MISC DESCRIPTION	11 IDENTIFICATION / SERIAL NUMBER	12 VALUE
--------	--------	-------	-------------	-----------------------------	------------------------	---------------------	-----------------------------------	----------

- Supplemental Case Cleared
 Gang Domestic Hate Child Abuse Elderly Abuse

Connecting Report Numbers:

Code Section / Description: 245(c) P.C.

Reclassify to:

Code: S-1 Name: Canley, Adrian



On 11/14/06, at approximately 1835 hours, I arrived at [REDACTED], Thousand Oaks, CA. I was asked by Sergeant Weaver, along with Det. Alvarez to conduct a door-to-door canvass of the apartment building to the rear of the complex, immediately south of the crime scene.

After speaking with [REDACTED] and getting information that a subject had ran from apartment # [REDACTED] down to the location of the shooting and come within an arms reach of Det. Matthews, I spoke with Det. Smith and Alvarez. We determined that further information about the occupants of # [REDACTED] was necessary prior to contacting the occupants.

I again spoke with [REDACTED] and asked to examine the rental agreement for the occupants of # [REDACTED]. The rental agreement showed that the apartment was rented to [REDACTED] (DOB [REDACTED]) and [REDACTED]. I telephoned Sheriff's Dispatch and requested a records check on [REDACTED] and a records check for the address. Dispatch advised that [REDACTED] did not have any warrants and was not currently on probation. They also advised that they could not locate any recent calls for service for the address.

Det. Smith, Alvarez and I approached apartment # [REDACTED]. I knocked on the door to the apartment. A female, identified as [REDACTED], answered my knocks at the door. As the

13. DATE / TIME OF REPORT 12-04-06 / 0953	14. REPORTING OFFICER / ID NO / DIV / UNIT Det. M. Harris / #3713 / East County Invest.	15. APPROVED BY / ID NO <i>[Signature]</i> / 12486
--	--	---

NARRATIVE REPORT VENTURA COUNTY SHERIFF'S DEPARTMENT

Page 2 of 2 Continuation

AGENCY IDENTIFIER CA0560000

1 RD 9072	2 BEAT 9G01	3 RB NUMBER 2006-30492
--------------	----------------	---------------------------

4 CODE	5 ITEM	6 QTY	7 ITEM NAME	8 BRAND / MAKE MANUFACTURER	9 MODEL NAME OR NUMBER	10 MISC. DESCRIPTION	11 IDENTIFICATION / SERIAL NUMBER	12 VALUE
--------	--------	-------	-------------	-----------------------------	------------------------	----------------------	-----------------------------------	----------

it could have been something else. She had heard that gunshots sound like a loud sound like that. She thought for a minute that the sound might be a gunshot but when she looked outside and did not see any commotion, she thought otherwise.

I asked [REDACTED] how many times she heard the sound. She stated a couple then a break then a couple more, for a total of four or five.

I completed my interview with [REDACTED]

13 DATE / TIME OF REPORT 12-04-06 / 0943	14 REPORTING OFFICER / ID NO / DIV / UNIT Det. M. Harris/#3713/East County Invest.	15 APPROVED BY / ID NO <i>J. [Signature]</i> / 2416
---	---	--

NARRATIVE REPORT VENTURA COUNTY SHERIFF'S DEPARTMENT

Page 1 of 2 Continuation

AGENCY IDENTIFIER CA0560000

1 RD 9072	2 BEAT 9G01	3 RB NUMBER 2006-30492
--------------	----------------	---------------------------

4 CODE	5 ITEM	6 QTY	7 ITEM NAME	8 BRAND / MAKE MANUFACTURER	9 MODEL NAME OR NUMBER	10 MISC DESCRIPTION	11 IDENTIFICATION / SERIAL NUMBER	12 VALUE
--------	--------	-------	-------------	-----------------------------	------------------------	---------------------	-----------------------------------	----------

- Supplemental Case Cleared
 Gang Domestic Hate Child Abuse Elderly Abuse

Connecting Report Numbers:

Code Section / Description: 245(c) P.C.

Reclassify to:

Code: S-1 Name: Canley, Adrian



On 11/14/06, at approximately 1835 hours, I arrived at [REDACTED], Thousand Oaks, CA. I was asked by Sergeant Weaver, along with Det. Alvarez to conduct a door-to-door canvass of the apartment building to the rear of the complex, immediately south of the crime scene.

I knocked on the door to apartment # [REDACTED]. A female, identified as [REDACTED], answered my knocks at the door. I asked [REDACTED] if I could come inside her apartment and speak with her and the other occupants.

The following is a summary of my digitally recorded conversation with [REDACTED], refer to CD for further details.

[REDACTED] stated she was inside her kitchen when she heard, what she thought was a person hitting a metal pan several times. After a couple of seconds, [REDACTED] then heard the same sound again. She peaked out her window and didn't see or hear anything. She didn't think anything of it until later when she went outside.

I asked [REDACTED] if she knew the sounds she heard were gunshots, firecrackers or a vehicle backfiring. She stated it just sounded like metal, being struck but the thought crossed her mind,

13 DATE / TIME OF REPORT 12-04-06 / 0955	14 REPORTING OFFICER / ID NO / DIV / UNIT Det. M. Harris / #3713 / East County Invest.	15 APPROVED BY / ID NO <i>[Signature]</i> / 12116
---	---	--

NARRATIVE REPORT VENTURA COUNTY SHERIFF'S DEPARTMENT

Page 4 of 4 Continuation

AGENCY IDENTIFIER CA0560000

1 RD 9072	2 BEAT 9G01	3 RB NUMBER 2006-30492
--------------	----------------	---------------------------

4 CODE	5 ITEM	6 QTY	7 ITEM NAME	8 BRAND / MAKE MANUFACTURER	9 MODEL NAME OR NUMBER	10 MISC. DESCRIPTION	11 IDENTIFICATION / SERIAL NUMBER	12 VALUE
--------	--------	-------	-------------	-----------------------------	------------------------	----------------------	-----------------------------------	----------

up the stairs at the same time. I asked [REDACTED] if he would be able to recognize the "the undercover cop" if seen again. [REDACTED] said he would not be able to identify the "undercover cop" if seen again. I questioned [REDACTED] as to how he knew that Det. Matthews was an "undercover cop". [REDACTED] said, "I saw his badge" but he did not see Det. Matthews gun. I asked for [REDACTED] to give me a further description of Det. Matthews. [REDACTED] stated that he thought Det. Matthews was a white male, wearing a black shirt. I asked [REDACTED] if Det. Matthews was the same person he saw holding a gun to the rear of the pickup truck. [REDACTED] said he was not sure, but thought there were actually two "undercover" officers. Since he saw Det. Matthews by the passenger side of Det. Matthews's vehicle. [REDACTED] said, "There was another guy with him, but I guess he stayed in the van." I again asked [REDACTED] if he saw anyone with Det. Matthews and he stated he only saw one person.

I asked [REDACTED] if he would be able to recognize Det. Matthews or the male with the pickup truck again if he was shown photographs. [REDACTED] said that he would not be able recognize the male from the pickup truck again since he did not get a good look at him.

I ended my interview with [REDACTED].

13 DATE / TIME OF REPORT 12-04-06 / 0939	14 REPORTING OFFICER / ID NO / DIV / UNIT Det. M. Harris/#3713/East County Invest.	15 APPROVED BY / ID NO <i>[Signature]</i> / 2486
---	---	---

NARRATIVE REPORT VENTURA COUNTY SHERIFF'S DEPARTMENT

Page 3 of 4 Continuation

AGENCY IDENTIFIER CA0560000

1 RD 9072	2 BEAT 9G01	3 RB NUMBER 2006-30492
--------------	----------------	---------------------------

4 CODE	5 ITEM	6 QTY	7 ITEM NAME	8 BRAND / MAKE MANUFACTURER	9 MODEL NAME OR NUMBER	10 MISC. DESCRIPTION	11 IDENTIFICATION / SERIAL NUMBER	12 VALUE
--------	--------	-------	-------------	-----------------------------	------------------------	----------------------	-----------------------------------	----------

At approximately 6:00 pm to 6:30 pm, she was seated at the dining room table doing her homework, when she heard shots. She stated that she did not hear any yelling or screaming prior to hearing the gunshots. [REDACTED] said that she heard approximately 4 gunshots.

[REDACTED] said she did not leave her apartment or go outside to see what had happened.

I ended my interview with [REDACTED].

[REDACTED]

The following is a synopsis of my digitally recorded conversation with [REDACTED] [REDACTED]. Refer to the CD for details.

[REDACTED] was inside his bedroom, with [REDACTED] and their three-year-old child. [REDACTED] said he heard gunshots but nothing before hearing the shots. After hearing the gunshot, [REDACTED] heard what he thought was a woman screaming. The female was screaming, "Stop! Stop!"

[REDACTED] stated that he believed he heard the incident at approximately 6:00 pm.

After hearing the shots [REDACTED] went outside to his rear balcony. He saw a subject holding a gun towards the rear of a truck. [REDACTED] said he did not know who the truck belonged to but said he saw it at the apartment complex "the other day" with a male, cleaning the truck. [REDACTED] further described the male as a "cholo type", wearing a white T-shirt, and a shave head.

[REDACTED] said that he thought the male was a new tenant at the apartment complex. He further stated that he never talked to the male but just saw the male once or twice prior to night.

I asked [REDACTED] if he saw Det. Matthews prior to seeing him behind the vehicle. [REDACTED] said that he saw "the undercover officer" when [REDACTED] was returning from the store and they walked

13 DATE / TIME OF REPORT 12-04-06 / 0939	14 REPORTING OFFICER / ID NO / DIV / UNIT Det. M. Harris/#3713/East County Invest.	15 APPROVED BY / ID NO [Signature] / 2486
---	---	--

NARRATIVE REPORT VENTURA COUNTY SHERIFF'S DEPARTMENT

Page 2 of 4 Continuation

AGENCY IDENTIFIER CA0560000

1 RD 9072	2 BEAT 9G01	3 RB NUMBER 2006-30492
--------------	----------------	---------------------------

4 CODE	5 ITEM	6 QTY	7 ITEM NAME	8 BRAND / MAKE MANUFACTURER	9 MODEL NAME OR NUMBER	10 MISC. DESCRIPTION	11 IDENTIFICATION / SERIAL NUMBER	12 VALUE
--------	--------	-------	-------------	-----------------------------	------------------------	----------------------	-----------------------------------	----------

I asked [REDACTED] if she knew what time she heard the yelling and the gunshots. She stated that she did not remember the time and did not look at the clock. [REDACTED] also said that she did not leave her apartment to see what had occurred outside.

I ended my interview with [REDACTED].

[REDACTED]

The following is a synopsis of my digitally recorded conversation with [REDACTED] [REDACTED]. Refer to the CD for details.

[REDACTED] was seated in the living room of the apartment. As she was seated, [REDACTED] heard a person outside of her apartment yelling, "Stop! Stop!" over and over again. I asked [REDACTED] how many times she heard the person yelling, "Stop! Stop!"? She stated, "More than ten times." After hearing the yelling [REDACTED] then heard three to four times gunshots.

[REDACTED] then did not hear anything. Her stepfather, [REDACTED] [REDACTED], came into the living room from his bedroom and told [REDACTED] to call 911. [REDACTED] said that she thought the sounds were from firecrackers when she called 911.

I asked [REDACTED] if she heard any people talking prior to hearing the yelling. [REDACTED] said she did not hear anything prior but initially thought the yelling were from people playing around. She said she believed that the incident occurred between 6:00 pm and 6:30 pm.

I ended my interview with [REDACTED].

[REDACTED]

The following is a synopsis of my digitally recorded conversation with [REDACTED] [REDACTED]. Refer to the CD for details.

13 DATE / TIME OF REPORT 12-04-06 / 0939	14 REPORTING OFFICER / ID NO / DIV / UNIT Det. M. Harris/#3713/East County Invest.	15 APPROVED BY / ID NO [Signature] / 2486
---	---	--

NARRATIVE REPORT VENTURA COUNTY SHERIFF'S DEPARTMENT

Page 1 of 4 Continuation

AGENCY IDENTIFIER CA0560000

1 RD 9072	2 BEAT 9G01	3 RB NUMBER 2006-30492
---------------------	-----------------------	----------------------------------

4 CODE	5 ITEM	6 QTY.	7 ITEM NAME	8 BRAND / MAKE MANUFACTURER	9 MODEL NAME OR NUMBER	10 MISC. DESCRIPTION	11 IDENTIFICATION / SERIAL NUMBER	12 VALUE
--------	--------	--------	-------------	-----------------------------	------------------------	----------------------	-----------------------------------	----------

- Supplemental** **Case Cleared**
 Gang **Domestic** **Hate** **Child Abuse** **Elderly Abuse**

Connecting Report Numbers:
Code Section / Description: 245(c) P.C.
 Reclassify to:
Code: S-1 Name: Canley, Adrian



On 11/14/06, at approximately 1835 hours, I arrived at [REDACTED], Thousand Oaks, CA. I was asked by Sergeant Weaver, along with Det. Alvarez to conduct a door-to-door canvass of the apartment building to the rear of the complex, immediately south of the crime scene.

I approached and knocked on the door of apartment [REDACTED]. The following is a synopsis of my digitally recorded conversation with [REDACTED]. Refer to the CD for details.

A female adult identified as [REDACTED] answered my knock on her door. I asked if I could speak with her and the occupants of the apartment. [REDACTED] invited me inside the apartment. [REDACTED] and I stood in the entry hallway, beside the kitchen area and she told me the following:

[REDACTED] was inside her bedroom, west bedroom, attempting to put her three-year-old daughter to sleep. As she was laying on her bed, [REDACTED] heard a person outside of her apartment yelling, "Stop! Stop! Stop!" After hearing the yelling [REDACTED] then heard three to four gunshots. [REDACTED] came out of her bedroom and into the living room to check on her daughters.

13 DATE / TIME OF REPORT 12-04-06 / 0937	14 REPORTING OFFICER / ID NO / DIV / UNIT Det. M. Harris/#3713/East County Invest.	15 APPROVED BY / ID NO <i>[Signature]</i> / 2486
--	--	--

NARRATIVE REPORT VENTURA COUNTY SHERIFF'S DEPARTMENT

Page 2 of 2 Continuation

AGENCY IDENTIFIER CA0560000

1 RD 9072	2 BEAT 9G01	3 RB NUMBER 2006-30492
--------------	----------------	---------------------------

4 CODE	5 ITEM	6 QTY	7 ITEM NAME	8 BRAND / MAKE MANUFACTURER	9 MODEL NAME OR NUMBER	10 MISC. DESCRIPTION	11 IDENTIFICATION / SERIAL NUMBER	12 VALUE
--------	--------	-------	-------------	-----------------------------	------------------------	----------------------	-----------------------------------	----------

exact number. I asked [REDACTED] if she heard anything prior to hearing the gunshots or after hearing the gunshots. She stated that she did not hear anything prior to the gunshots but after, she heard someone say, "Call 911!"

I asked [REDACTED] if she could tell if it was a male or female asking for someone to call 911. [REDACTED] said she thought it was a "women."

I ended my interview with [REDACTED].



The following is a synopsis of my digitally recorded conversation with [REDACTED] [REDACTED]. Refer to the CD for details. I spoke with [REDACTED] and she told me the following:

She thought she heard some [REDACTED], "but I'm not sure. I heard some barking outside. Then 911 and everything coming." I asked [REDACTED] if she heard any gunshots. She stated, "Yes. I not sure, about four or five, like she said. I am not really sure about that part." [REDACTED] said she did not hear anything prior to hearing the gunshots.

I ended my interview with [REDACTED].

13 DATE / TIME OF REPORT 12-04-06 / 0922	14 REPORTING OFFICER / ID NO / DIV / UNIT Det. M. Harris/#3713/East County Invest.	15 APPROVED BY / ID NO <i>[Signature]</i> / 12781
---	---	--

NARRATIVE REPORT VENTURA COUNTY SHERIFF'S DEPARTMENT

Page 1 of 2 Continuation

AGENCY IDENTIFIER CA0560000

1 RD 9072	2 BEAT 9G01	3 RS NUMBER 2006-30492
--------------	----------------	---------------------------

4 CODE	5 ITEM	6 QTY	7 ITEM NAME	8 BRAND / MAKE MANUFACTURER	9 MODEL NAME OR NUMBER	10 MISC. DESCRIPTION	11 IDENTIFICATION / SERIAL NUMBER	12 VALUE
--------	--------	-------	-------------	-----------------------------	------------------------	----------------------	-----------------------------------	----------

- Supplemental Case Cleared
 Gang Domestic Hate Child Abuse Elderly Abuse

Connecting Report Numbers:

Code Section / Description: 245(c) P.C.

Reclassify to:

Code: S-1 Name: Canley, Adrian



On 11/14/06, at approximately 1835 hours, I arrived at [REDACTED], Thousand Oaks, CA. I was asked by Sergeant Weaver, along with Det. Alvarez to conduct a door-to-door canvass of the apartment building to the rear of the complex, immediately south of the crime scene.

I approached and knocked on the door of apartment [REDACTED]. I initially did not get an answer at the door and began to walk away. I was approached by a male, later identified as (W) [REDACTED] that asked if I needed to speak with the occupants of the apartment. [REDACTED] stated he was the apartment manager and could help me in speaking with the occupants. [REDACTED] began knocking on the apartment door and stating his name. A female adult identified as [REDACTED] answered the knocks on her door. I asked if I could speak with her and the occupants of the apartment. [REDACTED] invited [REDACTED] and me inside the apartment. [REDACTED] and I stood in the living room area. [REDACTED] remained in the kitchen area of the apartment.

The following is a synopsis of my digitally recorded conversation with [REDACTED] [REDACTED]. Refer to the CD for details. I spoke with [REDACTED] and she told me the following:

She was on the telephone when she heard "gunshots". [REDACTED] said that she did not see anything. She stated that she heard four or five gunshots but could not really remember the

13 DATE / TIME OF REPORT 12-04-06 / 0921	14 REPORTING OFFICER / ID NO / DIV / UNIT 1449713 Det. M. Harris/#3713/East County Invest.	15 APPROVED BY / ID NO [Signature] / 2976
---	--	--

NARRATIVE REPORT VENTURA COUNTY SHERIFF'S DEPARTMENT

Page 2 of 2 Continuation

AGENCY IDENTIFIER CA0580000

1 RD 9072	2 BEAT 9G01	3 RB NUMBER 2006-30492
--------------	----------------	---------------------------

4 CODE	5 ITEM	6 QTY	7 ITEM NAME	8 BRAND / MAKE MANUFACTURER	9 MODEL NAME OR NUMBER	10 MISC. DESCRIPTION	11 IDENTIFICATION / SERIAL NUMBER	12 VALUE
--------	--------	-------	-------------	-----------------------------	------------------------	----------------------	-----------------------------------	----------

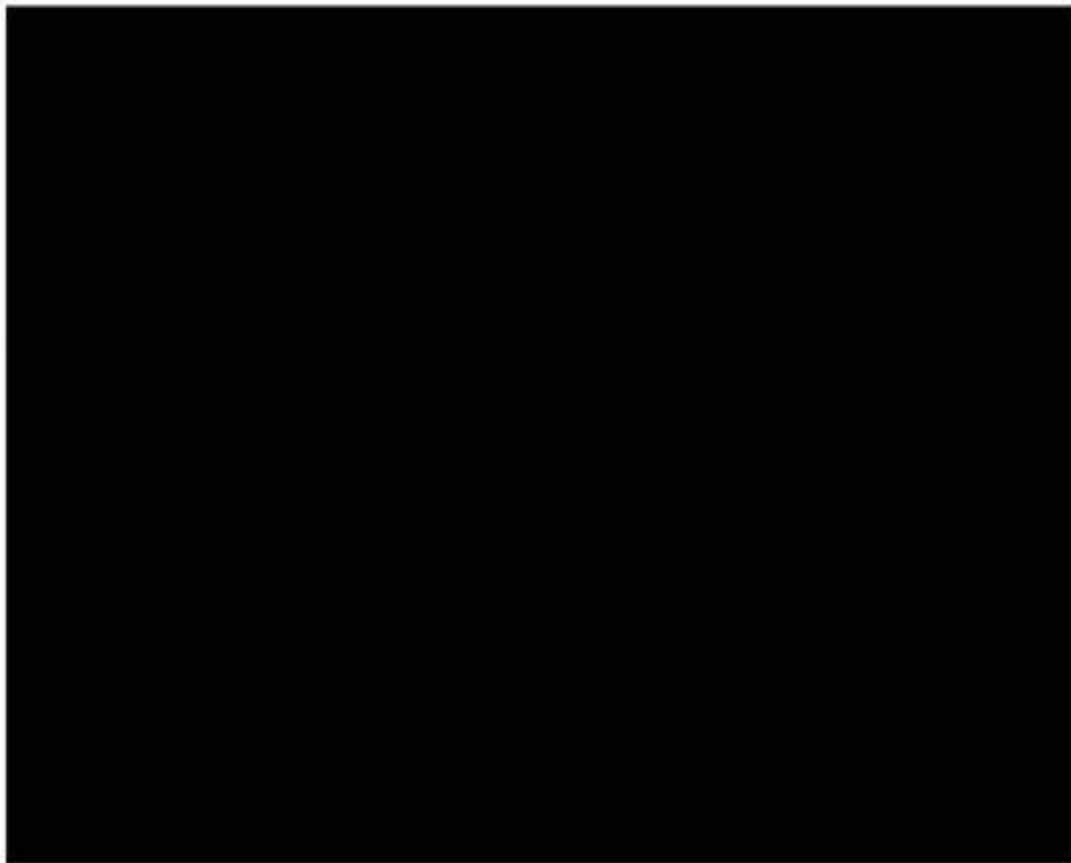

13 DATE / TIME OF REPORT 12-04-06 / 0915	14 REPORTING OFFICER / ID NO / DIV / UNIT rnf373 Det. M. Harris/#3713/East County Invest.	15 APPROVED BY / ID NO <i>[Signature]</i> / 2986
---	---	---

NARRATIVE REPORT VENTURA COUNTY SHERIFF'S DEPARTMENT

1 RD 9072	2 BEAT 9G01	3 RB NUMBER 2006-30492
--------------	----------------	---------------------------

Page 1 of 2 Continuation

AGENCY IDENTIFIER CA0560000

4 CODE	5 ITEM	6 QTY	7 ITEM NAME	8 BRAND / MAKE MANUFACTURER	9 MODEL NAME OR NUMBER	10 MISC. DESCRIPTION	11 IDENTIFICATION / SERIAL NUMBER	12 VALUE
--------	--------	-------	-------------	-----------------------------	------------------------	----------------------	-----------------------------------	----------

- Supplemental Case Cleared
 Gang Domestic Hate Child Abuse Elderly Abuse

Connecting Report Numbers:

Code Section / Description: 245(c) P.C.

Reclassify to:

Code: S-1 Name: Canley, Adrian

Area Canvass

On 11/14/06, at approximately 1835 hours, I arrived at [REDACTED], Thousand Oaks, CA. I was asked by Sergeant Weaver, along with Det. Alvarez to conduct a door-to-door canvass of the apartment building to the rear of the complex, immediately south of the crime scene.

I contacted the following residents and they stated they did not hear or see anything related to the incident.

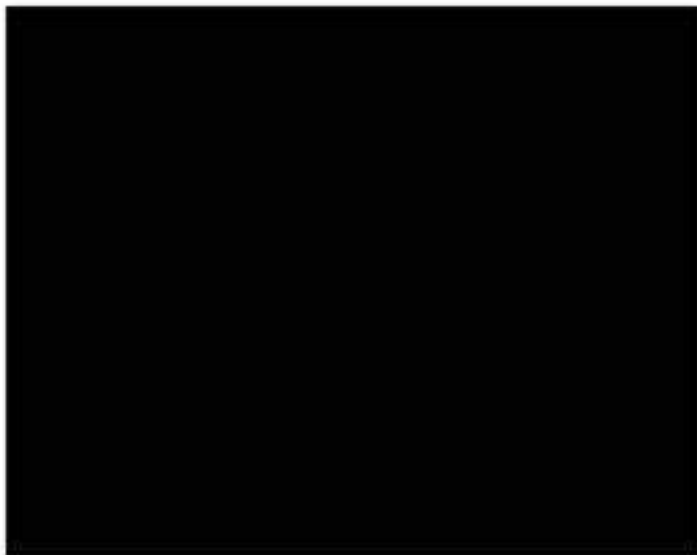

13 DATE / TIME OF REPORT 12-04-06 / 0915	14 REPORTING OFFICER / ID NO / DIV / UNIT Det. M. Harris/#3713/East County Invest.	15 APPROVED BY / ID NO <i>[Signature]</i>
---	---	--

NARRATIVE REPORT VENTURA COUNTY SHERIFF'S DEPARTMENT

Page 5 of 5 Continuation

AGENCY IDENTIFIER CA0560000

1 RD 9072	2 BEAT 9G01	3 RR NUMBER 06-30492
--------------	----------------	-------------------------

4 CODE	5 ITEM	6 QTY	7 ITEM NAME	8 BRAND / MAKE MANUFACTURER	9 MODEL NAME OR NUMBER	10 MISC DESCRIPTION	11 IDENTIFICATION / SERIAL NUMBER	12 VALUE
--------	--------	-------	-------------	-----------------------------	------------------------	---------------------	-----------------------------------	----------

with his wife and noticed the police were at the apartment complex. They were escorted to their apartment by the police.

I asked [REDACTED] if he knew (S) Canley and he stated he did not.

[REDACTED] was unresponsive to many of my questions, possibly due to his intoxication level. His wife assisted him in answering some of the questions. Harris interviewed [REDACTED]'s wife.

The C.D. containing the aforementioned interviews was booked into the Sheriff's Department East County property room.

13 DATE / TIME OF REPORT 11/20/06 / 09:58	14 REPORTING OFFICER / ID NO / DIV / UNIT L. Alvarez #2886 / ECPS / DETS <i>LA</i>	15 APPROVED BY / ID NO <i>[Signature]</i>
--	---	--

NARRATIVE REPORT VENTURA COUNTY SHERIFF'S DEPARTMENT

Page 4 of 5 Continuation

AGENCY IDENTIFIER CA0560000

1 RD 9072 2 BEAT 9G01 3 RB NUMBER 06-30492

4 CODE	5 ITEM	6 QTY	7 ITEM NAME	8 BRAND / MAKE MANUFACTURER	9 MODEL NAME OR NUMBER	10 MISC. DESCRIPTION	11 IDENTIFICATION / SERIAL NUMBER	12 VALUE
--------	--------	-------	-------------	-----------------------------	------------------------	----------------------	-----------------------------------	----------

Apartment # [REDACTED]

2105 hours

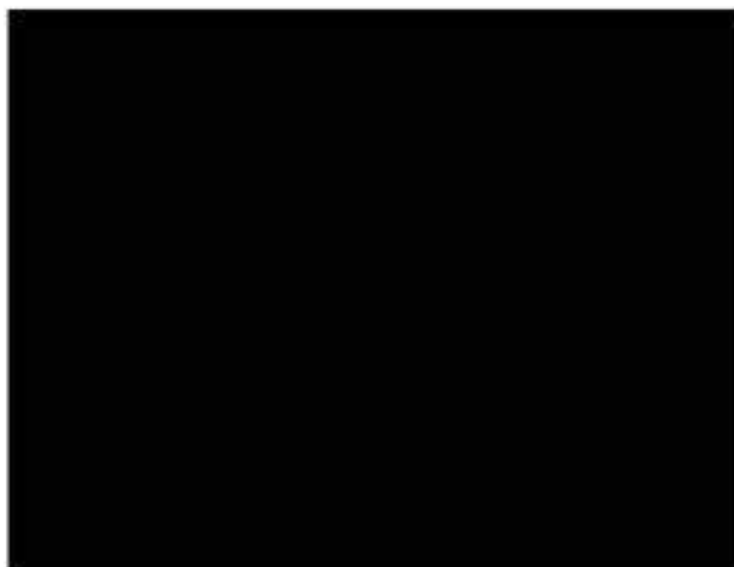

Through additional interviews by Detective Harris, he determined that (S) Canley could possibly be associated with the residents in apartment [REDACTED]. As a result, Detectives Harris, J. Smith and I responded to the residence for interviews. Refer to the interviews by Harris for further information.

[REDACTED] appeared intoxicated. He was very lethargic and would not respond to my questioning when asked specific questions. I still talked to [REDACTED] and the following is a synopsis of what he told me during a recorded interview.

I asked [REDACTED] his date of birth and he gave me a date of birth of [REDACTED] asked him what his age was and he told me [REDACTED], which did not equate to the date of birth he gave me. He then told me he did not know his exact age and then said he was [REDACTED] [REDACTED] was not very cooperative and stated he had some drinks earlier in the night.

I asked him if he knew anything about the shooting and he said he did not. I asked him if he was home and he told me he left his residence at about 1830 hours to pick up his wife from work (Ralphs). He did not see any police activity when he left the residence. He returned home at about 1930 hours

13 DATE / TIME OF REPORT 11/20/06 / 09:57	14 REPORTING OFFICER / ID NO / DIV / UNIT L. Alvarez #2886/ ECPS /DETS	15 APPROVED BY / ID NO <i>[Signature]</i>
--	---	--

NARRATIVE REPORT VENTURA COUNTY SHERIFF'S DEPARTMENT

Page 3 of 5 Continuation

AGENCY IDENTIFIER CA0560000

1 RD
9072

2 BEAT
9G01

3 RR NUMBER
06-30492

4 CODE	5 ITEM	6 QTY	7 ITEM NAME	8 BRAND / MAKE MANUFACTURER	9 MODEL NAME OR NUMBER	10 MISC DESCRIPTION	11 IDENTIFICATION / SERIAL NUMBER	12 VALUE
--------	--------	-------	-------------	-----------------------------	------------------------	---------------------	-----------------------------------	----------

Apartment # [REDACTED]

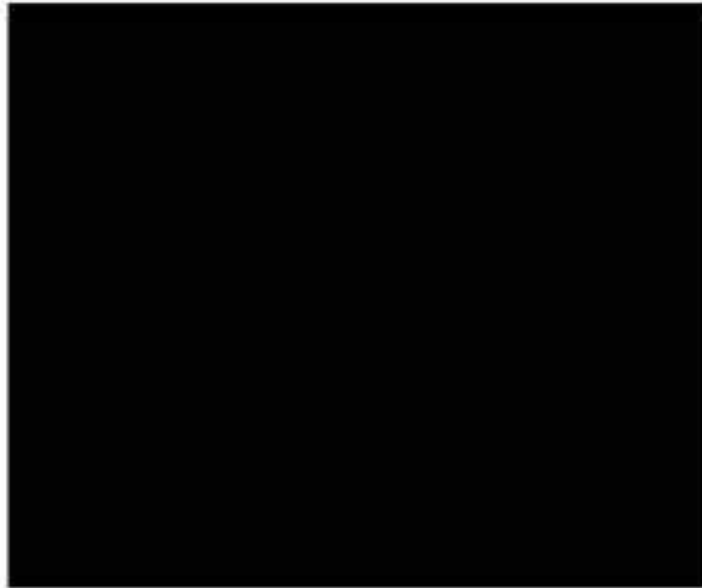

2005 hours

No answer

2020 hours

The following is a synopsis of what [REDACTED] told me during a recorded interview. She had just returned home after being at work. She was not aware of the incident until she arrived home. She did not hear or see anything pertaining to the incident.

[REDACTED]

2024 hours

No answer

13 DATE / TIME OF REPORT 11/20/06 / 09:57	14 REPORTING OFFICER / ID NO / DIV / UNIT L. Alvarez #2886/ ECPS /DETS	15 APPROVED BY / ID NO <i>[Signature]</i>
--	---	--

NARRATIVE REPORT VENTURA COUNTY SHERIFF'S DEPARTMENT

Page 2 of 5 Continuation

AGENCY IDENTIFIER CA0560000

1 RD 9072	2 BEAT 9G01	3 RB NUMBER 06-30492
--------------	----------------	-------------------------

4 CODE	5 ITEM	6 QTY	7 ITEM NAME	8 BRAND / MAKE MANUFACTURER	9 MODEL NAME OR NUMBER	10 MISC. DESCRIPTION	11 IDENTIFICATION / SERIAL NUMBER	12 VALUE
--------	--------	-------	-------------	-----------------------------	------------------------	----------------------	-----------------------------------	----------

While there, I canvassed the area of the apartment complex located at [REDACTED] for potential witnesses who may have heard or seen something pertaining to the incident. The block of apartments I canvassed is located to the south of the parking lot where the incident occurred.

I checked the following apartments and they were either vacant/no response or the residents did not hear or see anything pertaining to the incident.

[REDACTED]

1915 hours

I knocked on the door and there was no response. Detective Harris later advised me he spoke to the residents. They were home when I knocked, but were afraid to answer the door. Refer to Harris' report for the interviews.

[REDACTED]

Vacant

13 DATE / TIME OF REPORT 11/20/06 / 09:57	14 REPORTING OFFICER / ID NO / DIV / UNIT L. Alvarez #2886 / ECPS / DETS	15 APPROVED BY / ID NO <i>[Signature]</i>
--	---	--

NARRATIVE REPORT VENTURA COUNTY SHERIFF'S DEPARTMENT

Page 1 of 5 Continuation

AGENCY IDENTIFIER CA0560000

1 RD
9072

2 BEAT
9G01

3 RB NUMBER
06-30492

4 CODE	5 ITEM	6 QTY.	7 ITEM NAME	8 BRAND / MAKE MANUFACTURER	9 MODEL NAME OR NUMBER	10 MISC. DESCRIPTION	11 IDENTIFICATION / SERIAL NUMBER	12 VALUE
--------	--------	--------	-------------	-----------------------------	------------------------	----------------------	-----------------------------------	----------

- Supplemental**
 Case Cleared
 Reclassification
 Gang
 Domestic
 Hate
 Child Abuse
 Elderly Abuse
 ARRC

Connecting Report Numbers:

Code Section / Description: 245 (a)(1) P.C.

Code: V Name: Matthews, Shane

On 11/15/2006 at about 1820 hours, I heard dispatch send units to the area of Los Feliz Drive and Conejo School Road in reference to an officer involved shooting. I responded to assist in the investigation, which involved (V) Detective Shane Matthews and (S) Adrian Canley. I arrived a few minutes later and met with Sergeant C. Peterson who was already on scene. I was advised that Detective Matthews was involved in a shooting, which resulted in Canley receiving a gunshot wound to the area of his shoulder after he drove his truck at Mathews.

While there, I saw Canley on the ground, lying on his back, near the driver's side of his truck. Fire personnel were treating Canley and preparing to transport him to the hospital.

13 DATE / TIME OF REPORT 11/20/06 / 10:29	14 REPORTING OFFICER / ID NO / DIV / UNIT L. Alvarez #2886/ ECPS /DETS	15 APPROVED BY / ID NO <i>[Signature]</i>
--	---	--

NARRATIVE REPORT VENTURA COUNTY SHERIFF'S DEPARTMENT

Page 2 of 2 Continuation

AGENCY IDENTIFIER CA0560000

1 RD 9072	2 BEAT 9G01	3 RB NUMBER 06-30492
---------------------	-----------------------	--------------------------------

4 CODE	5 ITEM	6 QTY.	7 ITEM NAME	8 BRAND / MAKE MANUFACTURER	9 MODEL NAME OR NUMBER	10 MISC. DESCRIPTION	11 IDENTIFICATION / SERIAL NUMBER	12 VALUE
--------	--------	--------	-------------	-----------------------------	------------------------	----------------------	-----------------------------------	----------

About ten minutes after the gunshots, she went outside and saw the neighbors standing around. Brannigan stated she was the only home at the time.

The C.D. containing the interview was booked as evidence at the East County Sheriff's Department property room.

13 DATE / TIME OF REPORT
11/15/06 / 15:30

14 REPORTING OFFICER / ID NO / DIV / UNIT
L. Alvarez #2886/ ECPS /DETS

15 APPROVED BY / ID NO
Miller

NARRATIVE REPORT VENTURA COUNTY SHERIFF'S DEPARTMENT

Page 1 of 2 Continuation

AGENCY IDENTIFIER CA0560000

1 RD 2 BEAT 3 RB NUMBER
 9072 9601 06-30492

4 CODE	5 ITEM	6 QTY	7 ITEM NAME	8 BRAND / MAKE MANUFACTURER	9 MODEL NAME OR NUMBER	10 MISC. DESCRIPTION	11 IDENTIFICATION / SERIAL NUMBER	12 VALUE
--------	--------	-------	-------------	-----------------------------	------------------------	----------------------	-----------------------------------	----------

- Supplemental
 Case Cleared
 Reclassification
 Gang
 Domestic
 Hate
 Child Abuse
 Elderly Abuse
 ARRC

Connecting Report Numbers:

Code Section / Description: 245(a)(1) P.C.

Code: V Name: Mathews, Shane

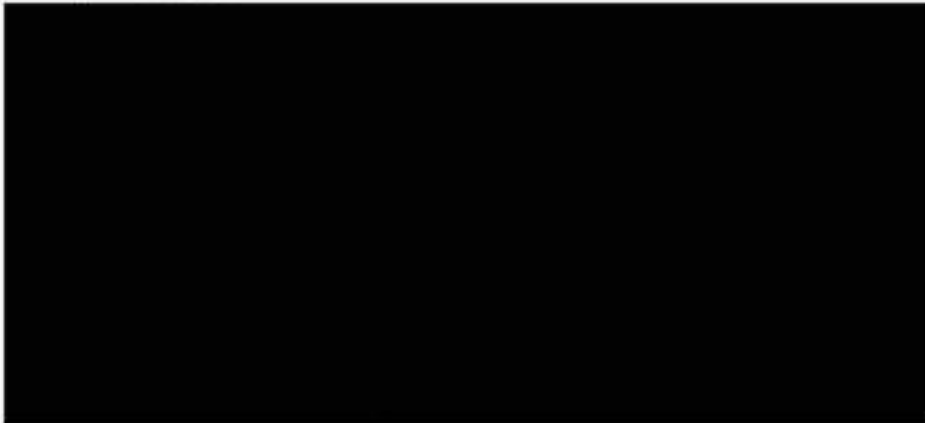

Apartment # [redacted]
 1915 hours

[redacted]'s apartment is located about 50 yards from the parking lot of the incident. I spoke to [redacted] and the following is a synopsis of what she told me during a recorded interview. She was in her bedroom. Her bedroom is located near the front door of the apartment. The window was slightly open. Between 1800 and 1830 hours, She heard two gunshots. After hearing the gunshots, she heard someone yell, "Stop. Stop it." She believed this was yelled out about three times and did not recognize an accent on the subject. After a short pause ("few seconds"), she heard three more gunshots. She then heard a person moaning as if they were in pain. She did not recall if it was after the first two gunshots or after all the gunshots.

After the gunshots, she looked out her window and saw a male talking on a cell phone. The person was on the sidewalk near the parking lot. [redacted] could not give a description of the subject but believed he was a white male. After talking to neighbors in the area, she believed it was the subject Mathews was talking to initially.

13 DATE / TIME OF REPORT 11/15/06 / 15:30	14 REPORTING OFFICER / ID NO / DIV / UNIT L. Alvarez #2886/ ECPS / DETS	15 APPROVED BY / ID NO MILLER 3056
--	--	---------------------------------------

NARRATIVE REPORT VENTURA COUNTY SHERIFF'S DEPARTMENT

Page 3 of 3 Continuation

AGENCY IDENTIFIER CA0560000

1 RD 9072 2 BEAT 9601 3 RB NUMBER 06-30492

4 CODE	5 ITEM	6 QTY	7 ITEM NAME	8 BRAND / MAKE MANUFACTURER	9 MODEL NAME OR NUMBER	10 MISC DESCRIPTION	11 IDENTIFICATION / SERIAL NUMBER	12 VALUE
--------	--------	-------	-------------	-----------------------------	------------------------	---------------------	-----------------------------------	----------



The following is a synopsis of what he told me during a recorded interview. [REDACTED] stated he was in the living room of the residence when he heard five gunshots. He heard two gunshots initially, a short pause and then three more gunshots. He did not go outside or talk to any of the neighbors about the incident.

The C.D. containing the aforementioned interviews was booked into the Sheriff's Department East County property room.

13 DATE / TIME OF REPORT 11/15/06 / 16:35	14 REPORTING OFFICER / ID NO / DIV / UNIT L. Alvarez #2886/ ECPS /DETS	15 APPROVED BY / ID NO <i>[Signature]</i>
--	---	--

NARRATIVE REPORT VENTURA COUNTY SHERIFF'S DEPARTMENT

Page 2 of 3 Continuation

AGENCY IDENTIFIER CA0560000

1 RD **9072** 2 BEAT **9G01** 3 RB NUMBER **06-30492**

4 CODE	5 ITEM	6 QTY	7 ITEM NAME	8 BRAND / MAKE MANUFACTURER	9 MODEL NAME OR NUMBER	10 MISC. DESCRIPTION	11 IDENTIFICATION / SERIAL NUMBER	12 VALUE
--------	--------	-------	-------------	-----------------------------	------------------------	----------------------	-----------------------------------	----------



The following is a synopsis of what [REDACTED] told me. He was in the living room when he heard two gunshots, a two second pause and then three more gunshots. He never went outside and did not talk to any of the neighbors about the incident. He did not have any additional information.

13 DATE / TIME OF REPORT
11/15/06 / 16:33

14 REPORTING OFFICER / ID NO / DIV / UNIT
L. Alvarez #2886/ ECPS /DETS

15 APPROVED BY / ID NO
[Signature]

NARRATIVE REPORT VENTURA COUNTY SHERIFF'S DEPARTMENT

1 RD 9072	2 BEAT 96	3 RB NUMBER 06-30492
--------------	--------------	-------------------------

Page 1 of 1 Continuation

AGENCY IDENTIFIER CA0560000

4 CODE	5 ITEM	6 QTY.	7 ITEM NAME	8 BRAND / MAKE MANUFACTURER	9 MODEL NAME OR NUMBER	10 MISC. DESCRIPTION	11 IDENTIFICATION / SERIAL NUMBER	12 VALUE
--------	--------	--------	-------------	-----------------------------	------------------------	----------------------	-----------------------------------	----------

Supplemental **Case Cleared**
 Gang **Domestic** **Hate** **Child Abuse** **Elderly Abuse**

Connecting Report Numbers:

Code Section / Description: 245(a)(1)/ADU **Code Section / Description**

Code: **Name:** MATTHEWS, SHANE

On 11-14-06, I was at the East County Sheriff's Station when I heard radio traffic regarding shots fired and a request for an ambulance. Det. Shane Matthews was on scene. I responded to the location, arriving at about 1830 hours.

Once on scene, I met with Sgt. Peterson (patrol), who briefed me on the circumstances and then asked me to assume control of the interviewing of witnesses or potential witnesses.

As various other personnel arrived on scene, including Major Crime's (Special Services) Detectives, they also affirmed my assignment to supervise the canvassing of the location for potential witnesses and to interview those who were in the area at the time of the incident.

As such, I oversaw the canvassing of the immediate apartment complex where the incident occurred, and the adjoining complex on the west side.

The personnel participating in the canvassing included the following East County detectives, Steve Sagely (Sgt.), Luis Alvarez, Bill Hutton, Jon Smith, Alan Devers, Eric Buschow, Gus Macias, and Brian Baker, and patrol deputies Kadosono #3628, Blank #3755 and Collins #3219.

Refer to the reports by each of the above listed personnel for the results of their canvassing and interviews.

I left the scene at approximately 2150 hours.

13 DATE / TIME OF REPORT <u>11-15-06 / 0930</u>	14 REPORTING OFFICER / ID NO / DIV / UNIT <u>J. WEAVER / 1276 / E.V. / DETS</u>	15 APPROVED BY / ID NO <u>J. [Signature] / 2416</u>
--	--	--

NARRATIVE REPORT VENTURA COUNTY SHERIFF'S DEPARTMENT

Page 2 of 2 Continuation

AGENCY IDENTIFIER CA0560000

1 RD 9072	2 BEAT 9601	3 RB NUMBER 060030492
--------------	----------------	--------------------------

4 CODE	5 ITEM	6 QTY	7 ITEM NAME	8 BRAND / MAKE MANUFACTURER	9 MODEL NAME OR NUMBER	10 MISC. DESCRIPTION	11 IDENTIFICATION / SERIAL NUMBER	12 VALUE
--------	--------	-------	-------------	-----------------------------	------------------------	----------------------	-----------------------------------	----------

I contacted [REDACTED] [REDACTED] (DOB 08-26-22) in apartment # [REDACTED] at approximately 2100 hours. [REDACTED] stated the following: [REDACTED] returned to his apartment from dinner at approximately 1815 hours. [REDACTED] heard three sounds like, "Pow, Pow, Pow." [REDACTED] ignored the sounds and continued to read his book. [REDACTED] did not see or hear anything else. [REDACTED]'s telephone number is (805) 370-5400.

I contacted [REDACTED] [REDACTED] in apartment # [REDACTED] at approximately 2105 hours. [REDACTED] stated the following: [REDACTED] stated she had been in the dining hall until approximately 1800 hours. [REDACTED] did not return to her apartment after dinner. [REDACTED] went to a friend's apartment on the other side of the building. [REDACTED] then went to play cards and returned to her apartment as I was knocking on her door. [REDACTED] did not see or hear anything. [REDACTED] telephone number is [REDACTED].

After completing my interviews, I remained on perimeter of the crime scene until approximately 0214 hours. I tape-recorded all of my contacts. I booked the tape, as evidence, into the East County Property Room.

13 DATE / TIME OF REPORT 11-15-06 / 0241	14 REPORTING OFFICER / ID NO. / DIV / UNIT D. KADOSONO *3628 / ECAS / 9801	15 APPROVED BY / ID NO. [Signature] / m86
---	---	--

NARRATIVE REPORT VENTURA COUNTY SHERIFF'S DEPARTMENT

Page 1 of 2 Continuation

AGENCY IDENTIFIER CA0560000

1 RD 9072	2 BEAT 9601	3 RB NUMBER 060030492
--------------	----------------	--------------------------

4 CODE	5 ITEM	6 QTY	7 ITEM NAME	8 BRAND / MAKE MANUFACTURER	9 MODEL NAME OR NUMBER	10 MISC. DESCRIPTION	11 IDENTIFICATION / SERIAL NUMBER	12 VALUE
--------	--------	-------	-------------	-----------------------------	------------------------	----------------------	-----------------------------------	----------

On 11-14-06, I was assigned to work patrol in the city of Thousand Oaks. At approximately 1917 hours, I responded to the command post, to assist with the investigation of an officer involved shooting that occurred at [REDACTED]. I was assigned to contact the residents of The [REDACTED] for any possible witnesses to the incident. The following people are residents I had contacted, who all had apartments with windows facing to the East, where the shooting had occurred.

I contacted [REDACTED] in apartment [REDACTED] at approximately 2015 hours. [REDACTED] stated the following: [REDACTED] returned to her apartment sometime around 1800 hours, from the dining hall. [REDACTED] has been in her apartment the entire evening, since returning home. [REDACTED] did not see or hear anything outside her apartment window. [REDACTED]'s telephone number is [REDACTED].

I contacted [REDACTED] in apartment [REDACTED] at approximately 2025 hours. [REDACTED] stated the following: [REDACTED] had been in the dining hall from approximately 1700 hours to 1800 hours. [REDACTED] did not see or hear anything. [REDACTED]'s telephone number is [REDACTED].

I attempted to contact resident [REDACTED] in apartment [REDACTED] at approximately 2030 hours. There was no answer at the door.

I attempted to contact resident [REDACTED] in apartment [REDACTED] at approximately 2035 hours. There was no answer at the door.

I contacted [REDACTED] in apartment [REDACTED] at approximately 2038 hours. [REDACTED] stated the following: [REDACTED] was in her apartment reading when she heard some shouting outside her window. [REDACTED] could not hear what was being shouted. [REDACTED] then heard three gunshots. [REDACTED] turned off her lights but did not look outside because she was afraid the gunshots could reach her. [REDACTED] eventually looked out of her window and saw all of the police cars. [REDACTED] did not see any of the incident. [REDACTED]'s telephone number is [REDACTED].

I attempted to contact apartment [REDACTED] at approximately 2043 hours. There was no answer at the door. I was later told apartment [REDACTED] is vacant.

I contacted [REDACTED] in apartment [REDACTED] at approximately 2055 hours. [REDACTED] stated the following: [REDACTED] returned from the dining hall at approximately 1800 hours. [REDACTED] did not see or hear anything outside of her window. [REDACTED]'s telephone number is [REDACTED].

13 DATE / TIME OF REPORT 11-15-06 / 0241	14 REPORTING OFFICER / ID NO / DIV / UNIT D. KADOSONO #3628 / ECAS / 9801	15 APPROVED BY / ID NO [Signature] / 1486
---	--	--

CRIME / INCIDENT REPORT

VENTURA COUNTY SHERIFF'S DEPARTMENT
AGENCY IDENTIFIER CA0560000

1 CONNECTING REPORT NUMBERS		2 RD 9072	3 BEAT 96	4 RB NUMBER 06-30492
-----------------------------	--	--------------	--------------	-------------------------

5 <input type="checkbox"/> CRIME <input type="checkbox"/> INCIDENT <input checked="" type="checkbox"/> SUPPLEMENTAL	6 <input type="checkbox"/> DOMESTIC <input type="checkbox"/> CHILD ABUSE <input type="checkbox"/> HATE
<input type="checkbox"/> CASE CLOSED <input type="checkbox"/> RECLASSIFICATION <input type="checkbox"/>	<input type="checkbox"/> GANG <input type="checkbox"/> ELDERLY ABUSE <input type="checkbox"/> ARRC

7 CODE SECTION / DESCRIPTION (INCIDENT) OFFICER INVOLVED SHOOTING	8 CLASS. <input type="checkbox"/> Misd. <input type="checkbox"/> Fel.	9 CODE SECTION / DESCRIPTION (<input type="checkbox"/> Reclassify To:)	10 CLASS. <input type="checkbox"/> Misd. <input type="checkbox"/> Fel.
11 CODE SECTION / DESCRIPTION (INCIDENT)	12 CLASS. <input type="checkbox"/> Misd. <input type="checkbox"/> Fel.	13 CODE SECTION / DESCRIPTION (<input type="checkbox"/> Reclassify To:)	14 CLASS. <input type="checkbox"/> Misd. <input type="checkbox"/> Fel.

15 OCCURRED FROM MO. DAY YR. TIME 11 14 06 1821	16 DOW TUE	17 OCCURRED TO MO. DAY YR. TIME	18 DOW
---	---------------	------------------------------------	--------

19 LOCATION OF OFFENSE / INCIDENT	ADDRESS	CITY	STATE	ZIP
				91362

20 CODE: V - VICTIM W - WITNESS R - REPORTING PARTY F - FINDER O - OWNER P - PARTY

40 VEH. LIC. NO. / STATE

41 VEH. COLOR / YEAR / MAKE / MODEL / BODY STYLE

42 OTHER CHARACTERISTICS / VIN NO.

43 CODE	44 NAME (Last, First, Middle, Gen.) / FIRM NAME	AKA / Moniker	RACE	SEX	47 HT	48 WT	49 HAIR	50 EYES	51 DOB	52 AGE
---------	---	---------------	------	-----	-------	-------	---------	---------	--------	--------

53 RESIDENCE ADDRESS / (<input type="checkbox"/> Same as Box # _____)	CITY	STATE	ZIP	54 RESIDENCE PHONE ()
--	------	-------	-----	---------------------------

55 BUSINESS / SCHOOL NAME	ADDRESS / (<input type="checkbox"/> Same as Box # _____)	CITY	STATE	ZIP	56 BUSINESS PHONE ()
---------------------------	---	------	-------	-----	--------------------------

57 OCCUPATION (<input type="checkbox"/> STUDENT)	58 DAYS OFF	59 WORK HRS	60 INTERPRETER	61 OPERATOR'S LIC. NO. / STATE
---	-------------	-------------	----------------	--------------------------------

62 VEH. LIC. NO. / STATE	63 VEH. COLOR / YEAR / MAKE / MODEL / BODY STYLE	64 OTHER CHARACTERISTICS / VIN NO.
--------------------------	--	------------------------------------

65 ARSON <input type="checkbox"/> Single Family Resd. <input type="checkbox"/> Inhabited <input type="checkbox"/> Uninhabited <input type="checkbox"/> Storage <input type="checkbox"/> Industrial <input type="checkbox"/> Commercial <input type="checkbox"/> Other Structure <input type="checkbox"/> Public Place <input type="checkbox"/> Vehicle <input type="checkbox"/> Unlawful Fire <input type="checkbox"/> Forest <input type="checkbox"/> Injury Occurred <input type="checkbox"/> Other	66 BURGLARY <input type="checkbox"/> Residential <input type="checkbox"/> Vehicle <input type="checkbox"/> Commercial <input type="checkbox"/> Other 67 ROBBERY <input type="checkbox"/> Bank <input type="checkbox"/> Chain Store <input type="checkbox"/> Commercial <input type="checkbox"/> Gas Station <input type="checkbox"/> Highway <input type="checkbox"/> Residence <input type="checkbox"/> Other	68 THEFT <input type="checkbox"/> Auto Parts <input type="checkbox"/> Bicycle <input type="checkbox"/> From Building <input type="checkbox"/> Coin Machine <input type="checkbox"/> From Person <input type="checkbox"/> From Vehicle <input type="checkbox"/> Purse Snatch <input type="checkbox"/> Shoplift <input type="checkbox"/> Other	69 FORCE / WEAPON <input type="checkbox"/> No Force <input type="checkbox"/> No Weapon <input type="checkbox"/> Verbal Only <input type="checkbox"/> Attempt Only <input type="checkbox"/> Great Bodily Injury <input type="checkbox"/> Firearm <input type="checkbox"/> Knife <input type="checkbox"/> Hands/Fists/Feet <input type="checkbox"/> Other	72 SPECIAL INTEREST (Copy to Agency/Unit) <input type="checkbox"/> Domestic Violence <input type="checkbox"/> Sex Crime <input type="checkbox"/> Child Abuse <input type="checkbox"/> HSA <input type="checkbox"/> Gang Related <input type="checkbox"/> Hate Crime <input type="checkbox"/> Agricultural <input type="checkbox"/> Probation <input type="checkbox"/> Parole <input checked="" type="checkbox"/> Other MAJOR CRIMES
--	--	---	--	--

69 VALUE / DOLLAR LOSS	70 DOMESTIC VIOLENCE / STALKING / SEX / HATE CRIMES
\$	<input type="checkbox"/> Per 264.2 PC, "Victims of Domestic Violence" pamphlet given to: <input type="checkbox"/> VICTIM (Includes sexual assault victims) <input type="checkbox"/> P-1 <input type="checkbox"/> P-2 <input type="checkbox"/> Per 6254 GC, Victim of DV, Stalking, Sex or Hate Crime requests his/her name be withheld from the public. <input type="checkbox"/> YES <input type="checkbox"/> NO
71 VALUE / DAMAGE LOSS	
\$	

73 DATE AND TIME REPORTED 11-14-06/1821	74 DATE / TIME OF REPORT 11-14-06/2250	75 REPORTING OFFICER / ID NO. / DIV / UNIT BUTRANU 3651 / E.C.P.S	76 APPROVED BY / ID NO. A. Arroyo / 1000
--	---	--	---

77 COPIES TO DET / MC NARC GANG / SEU STATS PRESS DOJ COURT

NARRATIVE REPORT VENTURA COUNTY SHERIFF'S DEPARTMENT

Page 3 of 3 Continuation

AGENCY IDENTIFIER CA0560000

1 RD 9072	2 BEAT 96	3 RB NUMBER 06-30492
--------------	--------------	-------------------------

4 CODE	5 ITEM	6 QTY	7 ITEM NAME	8 BRAND / MAKE MANUFACTURER	9 MODEL NAME OR NUMBER	10 MISC. DESCRIPTION	11 IDENTIFICATION / SERIAL NUMBER	12 VALUE
--------	--------	-------	-------------	-----------------------------	------------------------	----------------------	-----------------------------------	----------

On 11-14-06, I was working uniformed patrol in the city of Thousand Oaks. At approximately 1821 hours, I assisted units, reference an officer involved shooting that occurred at [REDACTED].

At about 1902 hours, I responded to Los Robles Hospital to assist Deputy Hawthorne with witness interviews.

I spoke to (W) [REDACTED], who is a paramedic with American Medical Response unit 452. The following is a summary of her tape-recorded statement: At about 1823 hours, [REDACTED] and her partner, (W) [REDACTED], were dispatched to [REDACTED], reference a gunshot victim.

Ventura County Fire Engine 31, and deputies were already on scene when they arrived at 1830 hours.

[REDACTED] said she saw a Hispanic male, (later identified as Adrian Canley), lying in the parking lot at the location. Canley was lying on his back shirtless, and was being treated by Ventura County Fire. She noticed Firefighter Nick [REDACTED] was preparing to intubate Canley. When she approached, she saw Canley had a gunshot wound above his right clavicle. Canley was unconscious and unresponsive.

[REDACTED] said she began treating Canley and inserted an IV into his left arm. After inserting the IV, [REDACTED] cut off Canley's pants and underwear in order to check for other wounds. After cutting his clothing, [REDACTED] pulled his pants out from under him as they prepared to move him onto the backboard. As she pulled Canley's pants to his right side, she saw a black handgun lying on his pants at the rear waistline area.

[REDACTED] said she yelled out that there was a gun. She heard somebody tell her not to touch the gun and a male deputy immediately walked over and stood next to the gun. They loaded Canley onto the gurney and transported him to Los Robles ER.

[REDACTED] described the gun as a large black semi-automatic handgun, possibly a 9mm, with about a 5in. barrel.

I terminated the interview. Refer to the cassette-tape for complete details.

Refer to Deputy Hawthorne's report for details reference [REDACTED]'s statement.

I booked the cassette-tape as evidence into the East County Property Room.

13 DATE / TIME OF REPORT 11-14-06 12250	14 REPORTING OFFICER / ID NO / DIV / UNIT BUTRACIN 3651 / E.C.P.S	15 APPROVED BY / ID NO [Signature]
--	--	---------------------------------------

PROPERTY / EVIDENCE REPORT

VENTURA COUNTY SHERIFF'S DEPARTMENT

AGENCY IDENTIFIER CA0560000

1 CONNECTING REPORT NUMBERS		2 RD 9072	3 BEAT 96	4 RB NUMBER 06-30492
5 PROPERTY TYPE: <input checked="" type="checkbox"/> EVIDENCE <input type="checkbox"/> FOUND <input type="checkbox"/> SAFEKEEPING		6 <input type="checkbox"/> Misdemeanor <input type="checkbox"/> Felony		7 DATE OF INCIDENT 11-14-06
8 INCIDENT / OFFENSE(S) (List all probable cause offenses pertaining to this RB.) OFFICER INVOLVED SHOOTING		9 LOCATION OF INCIDENT (STREET ADDRESS AND CITY)		
CODE: V - Victim S - Suspect A - Arrestee F - Finder O - Owner R - Reporting Party (Use Same Codes in Property Affiliation Boxes.)				
24 RESIDENCE ADDRESS / (<input type="checkbox"/> Same as Box # _____)		CITY	STATE	ZIP
25 RESIDENCE PHONE		()		
26 CODE	27 NAME (Last, First, Middle, Gen.) / FIRM NAME	AKA / Moniker	RACE 28	SEX 29
30 DOB		31 BUSINESS PHONE		
32 RESIDENCE ADDRESS / (<input type="checkbox"/> Same as Box # _____)		CITY	STATE	ZIP
33 RESIDENCE PHONE		()		
34 NARRATIVE				
35 PROPERTY / EVIDENCE INFORMATION				
LOCATION BOOKED: Ventura <input checked="" type="checkbox"/>		SEARCH WARRANT? Yes <input checked="" type="checkbox"/> No <input type="checkbox"/>		FINDER WISHES TO CLAIM? Yes <input checked="" type="checkbox"/> No <input type="checkbox"/>
36 PROPERTY CLASSIFICATION CODES				
E - EVIDENCE SK - SAFEKEEPING		RC - RECOVERED PROPERTY FP - FOUND PROPERTY		PROPERTY CODES
		A - CURRENCY/NOTES B - JEWELRY/PRECIOUS METALS C - CLOTHING/FURS		D - VEHICLE E - OFFICE EQUIPMENT F - ELECTRONIC EQUIPMENT
				G - FIREARMS H - HOUSEHOLD GOODS I - CONSUMABLE GOODS
				J - LIVESTOCK K - MISCELLANEOUS
CODE	ITEM #	QTY	ITEM NAME	MAKE
E/F	1	1	CASSETTE TAPE	
MODEL / CALIBER	ID / SERIAL NUMBER			
PROP. AFFIL.	ADDITIONAL INFORMATION			
	INTERVIEW WITH [REDACTED]			
CODE	ITEM #	QTY	ITEM NAME	MAKE
MODEL / CALIBER	ID / SERIAL NUMBER			
PROP. AFFIL.	ADDITIONAL INFORMATION			
CODE	ITEM #	QTY	ITEM NAME	MAKE
MODEL / CALIBER	ID / SERIAL NUMBER			
PROP. AFFIL.	ADDITIONAL INFORMATION			
37 DATE AND TIME OF REPORT 11-14-06 / 2250		38 REPORTING OFFICER / ID NO. / DIV / UNIT BUTMAN 3651 1E.C.P.S.		39 APPROVED BY / ID NO. [Signature]
40 COPIES TO <input type="checkbox"/> DET / MC <input type="checkbox"/> NARC <input type="checkbox"/> GANG / SEU <input type="checkbox"/> STATS <input type="checkbox"/> PRESS <input type="checkbox"/> DOJ <input type="checkbox"/> COURT <input checked="" type="checkbox"/> OTHER				

**PROPERTY / EVIDENCE
REPORT**

VENTURA COUNTY SHERIFF'S DEPARTMENT

AGENCY IDENTIFIER CA0560000

Page 2 of _____

41 FBI NUMBER

PROPERTY CLASSIFICATION CODES				PROPERTY CODES							
E - EVIDENCE		RC - RECOVERED PROPERTY		A - CURRENCY/NOTES		D - VEHICLE		G - FIREARMS		J - LIVESTOCK	
SK - SAFEKEEPING		FP - FOUND PROPERTY		B - JEWELRY/PRECIOUS METALS		E - OFFICE EQUIPMENT		H - HOUSEHOLD GOODS		K - MISCELLANEOUS	
				C - CLOTHING/FURS		F - ELECTRONIC EQUIPMENT		I - CONSUMABLE GOODS			
CODE	ITEM #	QTY	ITEM NAME	MAKE	MODEL / CALIBER	ID / SERIAL NUMBER					
PROP AFFIL	ADDITIONAL INFORMATION										
CODE	ITEM #	QTY	ITEM NAME	MAKE	MODEL / CALIBER	ID / SERIAL NUMBER					
PROP AFFIL	ADDITIONAL INFORMATION										
CODE	ITEM #	QTY	ITEM NAME	MAKE	MODEL / CALIBER	ID / SERIAL NUMBER					
PROP AFFIL	ADDITIONAL INFORMATION										
CODE	ITEM #	QTY	ITEM NAME	MAKE	MODEL / CALIBER	ID / SERIAL NUMBER					
PROP AFFIL	ADDITIONAL INFORMATION										
CODE	ITEM #	QTY	ITEM NAME	MAKE	MODEL / CALIBER	ID / SERIAL NUMBER					
PROP AFFIL	ADDITIONAL INFORMATION										
CODE	ITEM #	QTY	ITEM NAME	MAKE	MODEL / CALIBER	ID / SERIAL NUMBER					
PROP AFFIL	ADDITIONAL INFORMATION										
CODE	ITEM #	QTY	ITEM NAME	MAKE	MODEL / CALIBER	ID / SERIAL NUMBER					
PROP AFFIL	ADDITIONAL INFORMATION										
CODE	ITEM #	QTY	ITEM NAME	MAKE	MODEL / CALIBER	ID / SERIAL NUMBER					
PROP AFFIL	ADDITIONAL INFORMATION										
CODE	ITEM #	QTY	ITEM NAME	MAKE	MODEL / CALIBER	ID / SERIAL NUMBER					
PROP AFFIL	ADDITIONAL INFORMATION										
CODE	ITEM #	QTY	ITEM NAME	MAKE	MODEL / CALIBER	ID / SERIAL NUMBER					
PROP AFFIL	ADDITIONAL INFORMATION										

NARRATIVE REPORT VENTURA COUNTY SHERIFF'S DEPARTMENT

Page 1 of 4 Continuation

AGENCY IDENTIFIER CA0560000

1 PD 9072	2 BEAT 9G01	3 RS NUMBER 2006-30492
--------------	----------------	---------------------------

4 CODE	5 ITEM	6 QTY.	7 ITEM NAME	8 BRAND / MAKE MANUFACTURER	9 MODEL NAME OR NUMBER	10 MISC. DESCRIPTION	11 IDENTIFICATION / SERIAL NUMBER	12 VALUE
--------	--------	--------	-------------	-----------------------------	------------------------	----------------------	-----------------------------------	----------

Supplemental Case Cleared

Gang Domestic Hate Child Abuse Elderly Abuse

Connecting Report Numbers:

Code Section / Description: Officer Involved Shooting

Reclassify To:

Code: P Name: Canley, Adrian Doyle

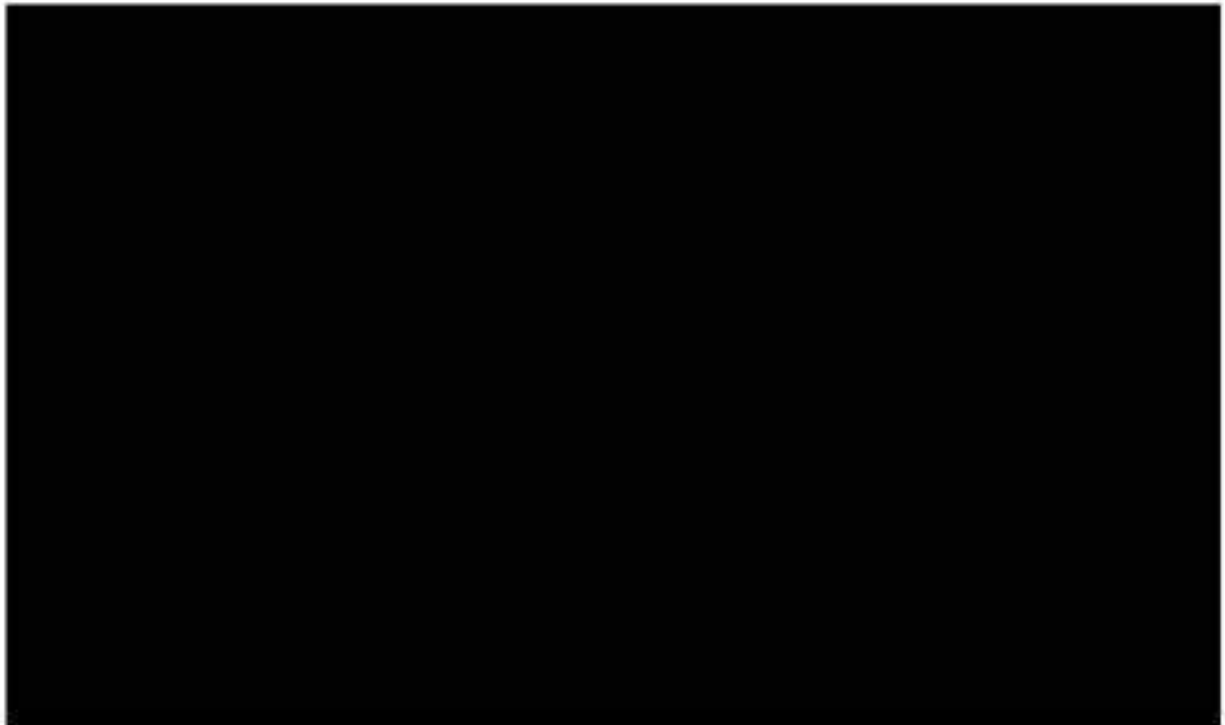

On November 14, 2006, at approximately 2028 hours, I interviewed Firefighter / Emergency Medical Technician [REDACTED], employed by the Ventura County Fire Department, in the Nurses Lounge at Los Robles Regional Medical Center in the City of Thousand Oaks. This interview was digitally recorded. The following is a summary of the interview. Refer to the CD ROM containing the recording for additional information:

13 DATE / TIME OF REPORT 11/16/06/ 6:08 PM	14 REPORTING OFFICER / ID NO / DIV / UNIT Det. S. Peterson #2238 / Spl. Svcs.	15 APPROVED BY / ID NO Sgt. Ayub #3318
---	--	---

NARRATIVE REPORT VENTURA COUNTY SHERIFF'S DEPARTMENT

Page 2 of 4 Continuation

AGENCY IDENTIFIER CA0560000

1 RD 9072	2 BEAT 9G01	3 RB NUMBER 2006-30492
--------------	----------------	---------------------------

4 CODE	5 ITEM	6 QTY	7 ITEM NAME	8 BRAND / MAKE MANUFACTURER	9 MODEL NAME OR NUMBER	10 MISC. DESCRIPTION	11 IDENTIFICATION / SERIAL NUMBER	12 VALUE
--------	--------	-------	-------------	-----------------------------	------------------------	----------------------	-----------------------------------	----------

██████ is normally assigned to Station 41 in the City of Simi Valley, however on the evening of November 14, 2006, he was working at Station 31 in the City of Thousand Oaks. He confirmed that on the evening of November 14, 2006, he responded to call of a gunshot victim at ██████ ██████ in the City of Thousand Oaks. ██████ said he was assigned to Engine 31 and was working a shift trade.

██████ could not recall the time he and the other fire personnel from Station 31 received the call of the gunshot victim. He explained that the fire personnel from Station 31 were at the scene of a traffic collision on the northbound 101 Freeway when the call of the gunshot victim was received. ██████ recalled that the dispatcher stated the call concerned a gunshot victim and the fire personnel were to stage for the arrival of the Sheriff's Department. He estimated it took approximately 3 minutes to get from the traffic collision scene to the scene of the gunshot victim. Other than Engine 31 and Squad 31, no additional fire personnel responded to the call.

██████ said he was a passenger in Engine 31. Engine 31 was parked heading into the driveway of the scene. He said the scene was located at an apartment complex. ██████ explained where the Sheriff's Department's vehicles were parked in relation to Engine 31. He said the gunshot victim was lying approximately 20 to 25 feet to the left (driver's side) of Engine 31.

Upon arrival, ██████ went to the two Firefighter / Paramedics who were treating the gunshot victim. He was told to supply oxygen to the gunshot victim because the gunshot victim was not breathing on his own.

██████ said the gunshot victim was lying "prone" with his head toward the direction of Engine 31. He clarified that the gunshot victim was lying on his back. ██████ said the gunshot victim's white T-shirt was in the process of being cut off. He continued that the gunshot victim was also wearing black "Levi type pants," a black leather belt with a chrome buckle, white "tennis shoes," and white socks.

13 DATE / TIME OF REPORT 11/16/06/ 6:08 PM	14 REPORTING OFFICER / ID NO / DIV / UNIT Det. S. Peterson #2238 / Spl. Svcs. <i>SP</i>	15 APPROVED BY / ID NO <i>BA</i> Sgt. Ayub #3318
---	--	--

NARRATIVE REPORT VENTURA COUNTY SHERIFF'S DEPARTMENT

Page 3 of 4 Continuation

AGENCY IDENTIFIER CA0560000

1. RD 9072	2. BEAT 9G01	3. RD NUMBER 2006-30492
---------------	-----------------	----------------------------

4. CODE	5. ITEM	6. QTY.	7. ITEM NAME	8. BRAND / MAKE MANUFACTURER	9. MODEL NAME OR NUMBER	10. MISC. DESCRIPTION	11. IDENTIFICATION / SERIAL NUMBER	12. VALUE
---------	---------	---------	--------------	------------------------------	-------------------------	-----------------------	------------------------------------	-----------

As [REDACTED] was supplying oxygen to the gunshot victim the Firefighter / Paramedics were preparing to insert "IV's" into the gunshot victim. He continued that "people" were cutting off the gunshot victim's clothing to expose any gunshot wounds. [REDACTED] explained how he continued to supply oxygen to the gunshot victim.

After the gunshot victim's chest was exposed and his shirt was removed, [REDACTED] saw a gunshot wound to the upper right "quadrant" of the gunshot victim's chest below his clavicle. He also saw that the gunshot victim's left thumb had a "nick" on it, but he could not tell if a bullet caused it. [REDACTED] described the injury to the gunshot victim's left thumb as an avulsion. He described that a "little flap" of skin was hanging off the gunshot victim's left thumb and there was a "little" blood.

[REDACTED] explained that the remainder of the time he was at the scene he was responsible for supplying oxygen to the gunshot victim. He noticed that the gunshot victim had "a lot" of tattoos on his upper chest area and arms. [REDACTED] said the gunshot victim's pants were cut off his body. He described the cuts as being along the sides of the gunshot victim's legs. [REDACTED] said as the emergency personnel tried to pull the gunshot victim's pants out from underneath him, a "gun appeared in the pants."

[REDACTED] described the gun as "black, probably composites." He continued that the gun appeared to be a "Glock," and confirmed that it was a semiautomatic gun. [REDACTED] said the gun was possibly a 40 caliber and appeared to be a caliber larger than a 9 millimeter (gun). He said the gun was in a firing position (the slide was not locked back). [REDACTED] did not know if the hammer on the gun was cocked. He said as the gunshot victim's pants were pulled out, the barrel of the gun was pointed toward the gunshot victim's right thigh area. [REDACTED] said the gun's grip was pointed "upwards" toward the gunshot victim's head. He did not know where the gun would have been placed in relation to the gunshot victim's body (before the pants were pulled away and the gun was exposed). When he saw the gun he believed it was above the gunshot victim's knee level near the gunshot victim's thigh level. [REDACTED] said the gun was lying on the ground as the gunshot victim's pants were being pulled away from the gunshot victim.

13. DATE / TIME OF REPORT 11/16/06/ 6:08 PM	14. REPORTING OFFICER / ID NO. / DIV / UNIT Det. S. Peterson #2238 / Spl. Svcs.	15. APPROVED BY / ID NO. Sgt. Ayub #3318
--	--	---

NARRATIVE REPORT VENTURA COUNTY SHERIFF'S DEPARTMENT

Page 4 of 4 Continuation

AGENCY IDENTIFIER CA0560000

1 PD 9072	2 BEAT 9G01	3 PD NUMBER 2006-30492
--------------	----------------	---------------------------

4 CODE	5 ITEM	6 QTY.	7 ITEM NAME	8 BRAND / MAKE MANUFACTURER	9 MODEL NAME OR NUMBER	10 MISC. DESCRIPTION	11 IDENTIFICATION / SERIAL NUMBER	12 VALUE
--------	--------	--------	-------------	-----------------------------	------------------------	----------------------	-----------------------------------	----------

████ said when he saw the gun a Firefighter / Paramedic alerted everyone that a gun was found and stated that the gun needed to be removed from the area. He said "everybody" said not to touch or move the gun and leave it where it was located. █████ said the gunshot victim's pants and gun were slid away from the gunshot victim so he could be placed onto a backboard. He said the gunshot victim's pants and gun were "laterally" slid away from the gunshot victim approximately 5 to 8 inches. █████ reiterated that no one touched the gun.

████ said a Deputy Sheriff was standing at the gunshot victim's feet. He clarified that after the Deputy Sheriff was told about the gun, the Deputy Sheriff came over and stood by the gunshot victim's feet. █████ said the Deputy Sheriff saw the gun and said not to move it until he could come back and secure the gun.

████ explained that the gunshot victim was placed onto a backboard and a gurney before being placed into the ambulance. He explained that he drove Squad 31 to the Emergency Room at Los Robles Regional Medical Center.

████ said the gunshot victim was never conscious at the scene and never made any statements.

████ had no additional information to add to this interview.

End of report.

13 DATE / TIME OF REPORT 11/16/06/ 6:08 PM	14 REPORTING OFFICER / ID NO / DIV / UNIT Det. S. Peterson #2238 / Spl. Svcs.	15 APPROVED BY / ID NO Sgt. Ayub #3318
---	--	---

NARRATIVE REPORT VENTURA COUNTY SHERIFF'S DEPARTMENT

Page 1 of 3 Continuation

AGENCY IDENTIFIER CA0560000

1 RD 9072	2 BEAT 9G01	3 RB NUMBER 2006-30492
---------------------	-----------------------	----------------------------------

4 CODE	5 ITEM	6 QTY.	7 ITEM NAME	8 BRAND / MAKE MANUFACTURER	9 MODEL NAME OR NUMBER	10 MISC. DESCRIPTION	11 IDENTIFICATION / SERIAL NUMBER	12 VALUE
--------	--------	--------	-------------	-----------------------------	------------------------	----------------------	-----------------------------------	----------

- Supplemental** **Case Cleared**
 Gang **Domestic** **Hate** **Child Abuse** **Elderly Abuse**

Connecting Report Numbers:

Code Section / Description: Officer Involved Shooting

Reclassify To:

Code: P **Name:** Canley, Adrian Doyle

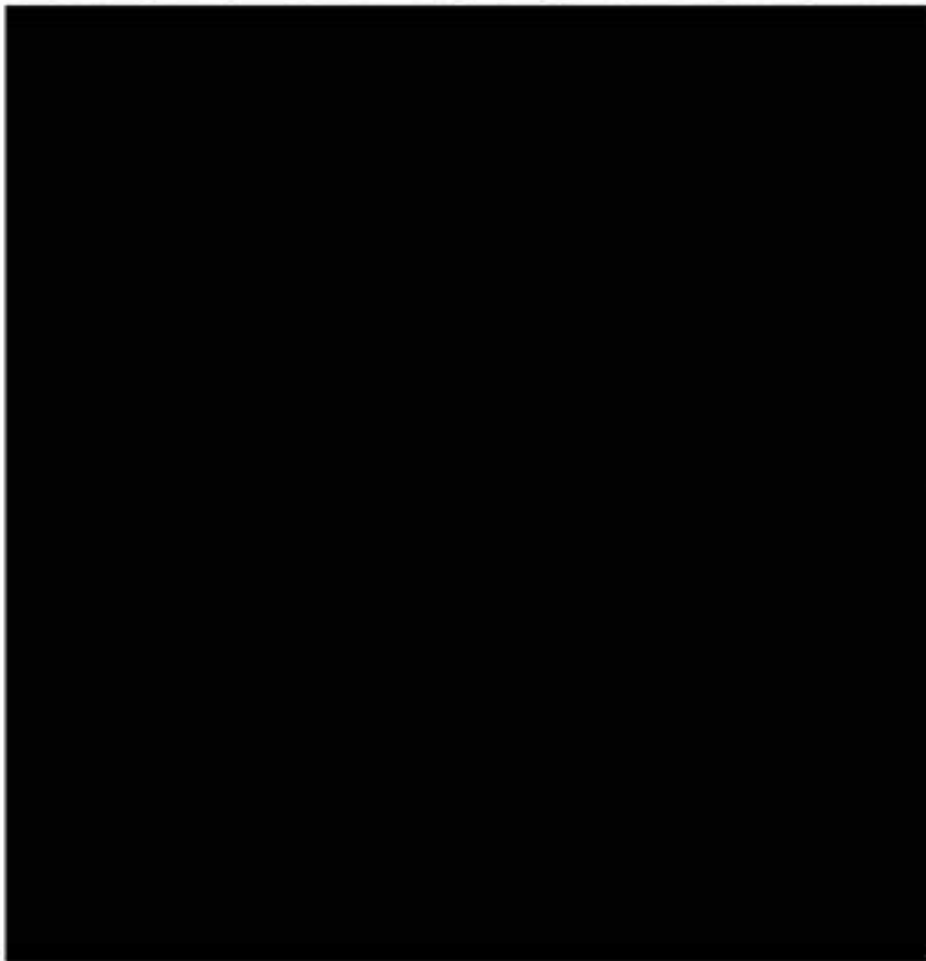

On November 14, 2006, at approximately 2043 hours, I interviewed Fire Cadet [REDACTED], employed by the Ventura County Fire Department, in the Nurses Lounge at Los Robles Regional Medical Center in the City of Thousand Oaks. This interview was digitally recorded.

13 DATE / TIME OF REPORT 11/16/06/ 7:12 PM	14 REPORTING OFFICER / ID NO / DIV / UNIT Det. S. Peterson #2238 / Spl. Svcs.	15 APPROVED BY / ID NO Sgt. Ayub #3318
--	---	--

NARRATIVE REPORT VENTURA COUNTY SHERIFF'S DEPARTMENT

Page 2 of 3 Continuation

AGENCY IDENTIFIER CA0560000

1 RD 9072	2 BEAT 9G01	3 RD NUMBER 2006-30492
--------------	----------------	---------------------------

4 CODE	5 ITEM	6 QTY	7 ITEM NAME	8 BRAND / MAKE MANUFACTURER	9 MODEL NAME OR NUMBER	10 MISC. DESCRIPTION	11 IDENTIFICATION / SERIAL NUMBER	12 VALUE
--------	--------	-------	-------------	-----------------------------	------------------------	----------------------	-----------------------------------	----------

The following is a summary of the interview. Refer to the CD ROM containing the recording for additional information:

█████ confirmed that on the evening of November 14, 2006, he was working at Station 31 as a Fire Cadet. He confirmed that on the evening of November 14, 2006, he responded to a call of a gunshot victim at ██████ in the City of Thousand Oaks.

█████ did not know what time the call for the gunshot victim was received. He explained that at the time the call was received, he and the fire personnel from Station 31 were at the scene of a traffic collision on the southbound 101 Freeway near Hampshire Road. ██████ said the dispatcher advised there was a gunshot victim at the aforementioned address. He responded to the scene in Squad 31 with Firefighter / Paramedic ██████ and Firefighter / Paramedic ██████. ██████ estimated it took approximately 10 minutes to get from the scene of the traffic collision to the scene of the gunshot victim.

█████ said the scene was located within an apartment complex. He said Firefighter / Paramedic ██████ drove Squad 31 to the call of the gunshot victim. Firefighter / Paramedic ██████ parked Squad 31 in front of the crime scene tape.

█████ said he exited Squad 31 and walked over to the gunshot victim. Firefighter / Paramedic ██████ told him to prepare an "IV" bag and he complied. ██████ said he held onto the "IV" bag for Firefighter / Paramedic ██████.

█████ said the gunshot victim was lying on his back. The gunshot victim was wearing unknown colored pants and no shirt. He did not know if the gunshot victim was wearing footwear.

After preparing the "IV" bag, ██████ held it until Firefighter / Paramedic ██████ retrieved it from him. ██████ saw a gunshot wound on the gunshot victim's right shoulder near his "collar bone." He explained that he held onto the "IV" bag during the entire time he was at the scene. ██████

13 DATE / TIME OF REPORT 11/16/06/ 7:12 PM	14 REPORTING OFFICER / ID NO / DIV / UNIT Det. S. Peterson #2238 / Spl. Svcs. <i>SP</i>	15 APPROVED BY / ID NO <i>BA</i> Sgt. Ayub #3318
---	--	--

NARRATIVE REPORT VENTURA COUNTY SHERIFF'S DEPARTMENT

Page 3 of 3

Continuation

AGENCY IDENTIFIER CA0560000

1 RD 9072	2 BEAT 9G01	3 RB NUMBER 2006-30492
--------------	----------------	---------------------------

4 CODE	5 ITEM	6 QTY.	7 ITEM NAME	8 BRAND / MAKE MANUFACTURER	9 MODEL NAME OR NUMBER	10 MISC. DESCRIPTION	11 IDENTIFICATION / SERIAL NUMBER	12 VALUE
--------	--------	--------	-------------	-----------------------------	------------------------	----------------------	-----------------------------------	----------

said the gunshot victim's eyes were open, but he did not know if he was conscious. He said the gunshot victim never made any statements.

█████ said he saw a gun at the scene after the gunshot victim's pants were cut off. He explained that he was holding the "IV" bag and the emergency personnel were preparing the gunshot victim to be moved. ██████ said he "stepped back" and saw the gun. He said Firefighter / Paramedic ██████ told a Deputy Sheriff that a gun was present. ██████ commented that Firefighter / Paramedic ██████ did not want to touch the gun. He said the gun was on the gunshot victim's pants that had been "cut up." ██████ said the gunshot victim's pants were "cut up" and off the gunshot victim's body when he saw the gun. He said the gun was by the gunshot victim's feet. ██████ then stated the gun was by the gunshot victim's calves. He clarified that the gun was near the gunshot victim's right calf. I asked ██████ to describe the gun. He said, "Silver top, black handle. It's all I can remember."

I showed ██████ my department issued semiautomatic gun. He confirmed that the gunshot victim's gun resembled my semiautomatic gun. ██████ said the gun's grip was on "the side" and the gun's barrel was "facing up." He could not remember which direction the gunshot victim's gun barrel was pointed or where the gun's grip was pointed. ██████ said he did not see a Deputy Sheriff at the scene secure the gun.

█████ said the gunshot victim was then placed onto a backboard and was placed inside the ambulance. He explained that he drove to the Emergency Room at Los Robles Regional Medical Center in Squad 31 with Firefighter / Emergency Medical Technician ██████.

█████ said the gunshot victim never regained consciousness or made any statements.

█████ had no additional information to add to this interview.

End of report.

13 DATE / TIME OF REPORT 11/16/06/ 7:12 PM	14 REPORTING OFFICER / ID NO. / DIV. / UNIT Det. S. Peterson #2238 / Spl. Svcs. <i>SP</i>	15 APPROVED BY / ID NO. Sgt. Ayub #3318 <i>BA</i>
---	--	--

NARRATIVE REPORT VENTURA COUNTY SHERIFF'S DEPARTMENT

Page 1 of 6 Continuation

AGENCY IDENTIFIER CA0560000

1 RD 9072	2 BEAT 9G01	3 RB NUMBER 2006-30492
--------------	----------------	---------------------------

4 CODE	5 ITEM	6 QTY.	7 ITEM NAME	8 BRAND / MAKE MANUFACTURER	9 MODEL NAME OR NUMBER	10 MISC. DESCRIPTION	11 IDENTIFICATION / SERIAL NUMBER	12 VALUE
--------	--------	--------	-------------	-----------------------------	------------------------	----------------------	-----------------------------------	----------

Supplemental Case Cleared

Gang Domestic Hate Child Abuse Elderly Abuse

Connecting Report Numbers:

Code Section / Description: Officer Involved Shooting

Reclassify To:

Code: P Name: Canley, Adrian Doyle

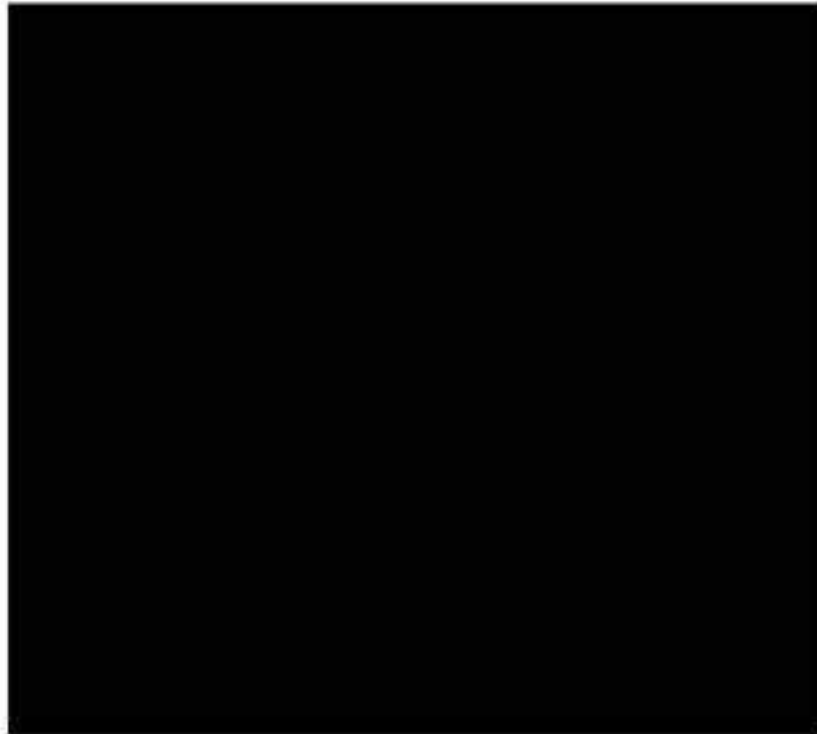

On November 14, 2006, at approximately 1940 hours, I interviewed Paramedic [REDACTED], employed by American Medical Response (ambulance company), in the Nurses Lounge at Los Robles Regional Medical Center in the City of Thousand Oaks. This interview was digitally recorded. The following is a summary of the interview. Refer to the CD ROM containing the recording for additional information:

13 DATE / TIME OF REPORT 11/15/06/ 7:58 PM	14 REPORTING OFFICER / ID NO / DIV / UNIT Det. S. Peterson #2238 / Spl. Svcs. <i>SP</i>	15 APPROVED BY / ID NO Sgt. Ayub #3318 <i>BA</i>
---	--	---

NARRATIVE REPORT VENTURA COUNTY SHERIFF'S DEPARTMENT

Page 2 of 6 Continuation

AGENCY IDENTIFIER CA0560000

1 RD 9072	2 BEAT 9G01	3 RB NUMBER 2006-30492
--------------	----------------	---------------------------

4 CODE	5 ITEM	6 QTY.	7 ITEM NAME	8 BRAND / MAKE MANUFACTURER	9 MODEL NAME OR NUMBER	10 MISC. DESCRIPTION	11 IDENTIFICATION / SERIAL NUMBER	12 VALUE
--------	--------	--------	-------------	-----------------------------	------------------------	----------------------	-----------------------------------	----------

████████ confirmed that on the evening of November 14, 2006, she responded to a call of a gunshot victim at ██████████ in the City of Thousand Oaks. She was working with Emergency Medical Technician ██████████. They were assigned as "Medic 452."

At approximately 1823 hours, ██████████ and ██████████ received the call concerning the gunshot victim while they were inside "Borcer's" bookstore in the City of Thousand Oaks. The call was received on their handheld radio and was "a little broken." As they walked out of the establishment, ██████████ heard the dispatcher advise the call concerned a gunshot victim at 2222 Los Feliz Drive. The dispatcher also advised to standby for the arrival of the Sheriff's Department. ██████████ explained that she and ██████████ were initially dispatched with Engine 34 from the Ventura County Fire Department. She continued that Engine 31, from the Ventura County Fire Department, was at the scene of a nearby call and responded to the gunshot victim call along with Squad 31 from the Ventura County Fire Department.

████████ explained that she and ██████████ were cleared to enter the scene prior to their arrival at the scene at approximately 1830 hours. She was driving the ambulance. ██████████ parked the ambulance on the driveway of the apartment complex where the scene was located. She also explained where the vehicles from the Ventura County Fire Department were parked at the scene.

After parking, ██████████ told ██████████ to retrieve the gurney because they would not need their medical equipment since Paramedics from the Ventura County Fire Department were on scene. She walked toward the location where the gunshot victim was being treated and saw a Firefighter walking toward the scene with medical equipment. ██████████ said it appeared that Firefighter / Paramedic ██████████ was preparing to intubate the gunshot victim who was "unconscious and unresponsive."

████████ asked the Firefighter / Paramedics what they wanted her to do as they were in control of the scene. Firefighter / Paramedic ██████████ was attempting to insert an intravenous needle into the gunshot victim's right arm and asked her to begin an "IV" in the gunshot victim's

13 DATE / TIME OF REPORT 11/15/06/ 7:58 PM	14 REPORTING OFFICER / ID NO / DIV / UNIT Det. S. Peterson #2238 / Spl. Svcs. <i>SP</i>	15 APPROVED BY / ID NO <i>BA</i> Sgt. Ayub #3318
---	--	--

NARRATIVE REPORT VENTURA COUNTY SHERIFF'S DEPARTMENT

Page 3 of 6 Continuation

AGENCY IDENTIFIER CA0560000

1 RD 9072	2 BEAT 9G01	3 RB NUMBER 2006-30492
--------------	----------------	---------------------------

4 CODE	5 ITEM	6 QTY	7 ITEM NAME	8 BRAND / MAKE MANUFACTURER	9 MODEL NAME OR NUMBER	10 MISC. DESCRIPTION	11 IDENTIFICATION / SERIAL NUMBER	12 VALUE
--------	--------	-------	-------------	-----------------------------	------------------------	----------------------	-----------------------------------	----------

left arm. Based on the first name of the Firefighter / Paramedic being [REDACTED], I believe [REDACTED] was actually referring to Firefighter / Paramedic [REDACTED] [REDACTED]. For the remainder of this report I shall refer to the Firefighter / Paramedic as [REDACTED] [REDACTED] or [REDACTED] as that was the name told to me by [REDACTED].

[REDACTED] said the gunshot victim was lying on his back with his head pointed toward where she had parked the ambulance. She was told that four shots had been fired and the gunshot victim had been struck by one bullet. [REDACTED] explained that the information concerning the gunshots was provided to her by an unknown Firefighter at the scene.

[REDACTED] said the gunshot victim was not wearing a shirt. He was wearing black jeans, a belt, and white "sneaker type tennis shoes." [REDACTED] saw that the gunshot victim had one gunshot wound above his right clavicle, but she could not see any other "obvious" wounds.

[REDACTED] went to the left side of the gunshot victim's body and began trying to start an "IV" on the gunshot victim's left arm. She did not notice any weapons lying around the area where the gunshot victim was located. [REDACTED] completed the "IV" in the gunshot victim's left arm. She said "somebody" had asked that the remaining clothing on the gunshot victim be cut off.

[REDACTED] explained that as she completed the "IV" an unknown person had cut the legs of the gunshot victim's pants up the front from the cuff to just below the waist. She believed that a Firefighter had completed the cuts. [REDACTED] did not notice anything when she initially saw the legs of the gunshot victim after his pants had been cut.

[REDACTED] said the "other" Firefighter / Paramedic was still attempting to establish an "IV" on the gunshot victim as medical treatment continued. She removed the gunshot victim's shoes and socks and checked his legs for injury. [REDACTED] said [REDACTED] was standing by the gurney and she asked him for scissors to complete the cutting of the legs of the gunshot victim's pants. She continued that she cut the legs of the gunshot victim's pants up to and through the waist, and also cut through his multi-colored striped boxer shorts. [REDACTED] then checked for additional injuries. She confirmed that she completed the cuts on the gunshot victim's pants where the

10 DATE / TIME OF REPORT 11/15/06/ 7:58 PM	14 REPORTING OFFICER / ID NO / DIV / UNIT Det. S. Peterson #2238 / Spl. Svcs. <i>SP</i>	15 APPROVED BY / ID NO <i>BA</i> Sgt. Ayub #3318
---	--	--

NARRATIVE REPORT VENTURA COUNTY SHERIFF'S DEPARTMENT

Page 4 of 6

Continuation

AGENCY IDENTIFIER CA0560000

1 RD 9072	2 BEAT 9G01	3 RB NUMBER 2006-30492
--------------	----------------	---------------------------

4 CODE	5 ITEM	6 QTY.	7 ITEM NAME	8 BRAND / MAKE MANUFACTURER	9 MODEL NAME OR NUMBER	10 MISC. DESCRIPTION	11 IDENTIFICATION / SERIAL NUMBER	12 VALUE
--------	--------	--------	-------------	-----------------------------	------------------------	----------------------	-----------------------------------	----------

Firefighter had ended his cuts. ██████ explained that she was able to open the gunshot victim's pants and boxer shorts in a "butterfly" fashion exposing his groin area and legs. She did not notice anything when she initially cut and opened the gunshot victim's pants and boxer shorts. ██████ explained that she and the other emergency personnel at the scene then prepared to place the gunshot victim onto a backboard. She lifted the gunshot victim's left leg as Firefighter / Paramedic ██████ pulled the gunshot victim's pants toward the right side of the gunshot victim's body. ██████ explained that Firefighter / Paramedic ██████ was on the right side of the gunshot victim.

██████ explained that as Firefighter / Paramedic ██████ was pulling the gunshot victim's pants away they both saw a gun. She explained that the gun was on top of the gunshot victim's pants near the area of his waistband on the back of his body. ██████ said it was correct for me to say that based on the placement of the gun, the gunshot victim might have placed the gun behind his back inside the waistband of his pants. She clarified that she felt the gun would have been fully concealed inside the back of the gunshot victim's pants. ██████ said the gun was a "large automatic, black -- solid black handle (grip)."

I showed ██████ my department issued semiautomatic gun and she confirmed that the gunshot victim's gun resembled my gun. She said the gunshot victim's gun was as large as my gun. ██████ did not know if the gunshot victim's gun had been fired and noticed nothing unusual about it. She confirmed that the gunshot victim's gun appeared to be ready to be fired (the slide was not locked back). ██████ said that both she and Firefighter / Paramedic ██████ both verbalized to everyone near them that they saw the gun. An unknown person told her and Firefighter / Paramedic ██████ not to touch the gun.

██████ said a Deputy Sheriff walked over to her and "stood by" the gun. She explained that when she and Firefighter / Paramedic ██████ initially saw the gun, Firefighter / Paramedic ██████ stopped pulling the gunshot victim's pants. ██████ repeated that she was told not to touch "anything." She and Firefighter / Paramedic ██████ continued to move the gunshot victim and left the gun on the top of the gunshot victim's clothing.

13 DATE / TIME OF REPORT 11/15/06/ 7:58 PM	14 REPORTING OFFICER / ID NO. / DIV / UNIT Det. S. Peterson #2238 / Spl. Svcs.	15 APPROVED BY / ID NO. Sgt. Ayub #3318
---	---	--

NARRATIVE REPORT VENTURA COUNTY SHERIFF'S DEPARTMENT

Page 5 of 6 Continuation

AGENCY IDENTIFIER CA0560000

1 RD 9072	2 BEAT 9G01	3 RB NUMBER 2006-30492
--------------	----------------	---------------------------

4 CODE	5 ITEM	6 QTY	7 ITEM NAME	8 BRAND / MAKE MANUFACTURER	9 MODEL NAME OR NUMBER	10 MISC. DESCRIPTION	11 IDENTIFICATION / SERIAL NUMBER	12 VALUE
--------	--------	-------	-------------	-----------------------------	------------------------	----------------------	-----------------------------------	----------

████████ confirmed that a Deputy Sheriff retrieved the gun. She explained that the Deputy Sheriff initially stood by as she heard someone say "something" about "pictures." ██████ said she did not observe the Deputy Sheriff retrieve the gun, but there were two Deputy Sheriff's by the gun. The last time she saw the gun it was on the gunshot victim's clothing after the clothing had been removed from the gunshot victim's body and left on the ground.

████████ said the gunshot victim was rolled onto his right side to check for any gunshot wounds on his back. No gunshot wounds were found. The gunshot victim was rolled back onto his back and slid onto a backboard. ██████ continued to explain how the gunshot victim was secured on the backboard and gurney before being moved to the ambulance.

████████ confirmed that the gunshot victim was transported directly from the scene to the Emergency Room at the Los Robles Regional Medical Center in the City of Thousand Oaks with the use of emergency lights and siren (Code 3). ██████ drove the ambulance while ██████ Firefighter / Paramedic ██████ and Firefighter / Paramedic Winter remained in the back of the ambulance providing medical treatment to the gunshot victim. ██████ explained what type of medical treatment she and the Firefighter / Paramedics provided the gunshot victim. She said no Deputy Sheriff's were riding in the ambulance and she did not know if a Deputy Sheriff followed the ambulance in a marked patrol vehicle to the medical center.

████████ said while the gunshot victim was being transported to the medical center he did not experience any medical problems where cardiopulmonary resuscitation had to be performed. She explained that the gunshot victim's breathing was being controlled and he had a heartbeat and a "rhythm" during the transport to the medical center. ██████ estimated it took approximately seven to eight minutes to get to the medical center from the scene.

████████ said the gunshot victim did not regain consciousness during the transport from the scene to the medical center, or while at the scene. She confirmed that the gunshot victim never made any statements.

13 DATE / TIME OF REPORT 11/15/06/ 7:58 PM	14 REPORTING OFFICER / ID NO / DIV / UNIT Det. S. Peterson #2238 / Spl. Svcs. <i>SP</i>	15 APPROVED BY / ID NO <i>SA</i> Sgt. Ayub #3318
---	--	--

NARRATIVE REPORT VENTURA COUNTY SHERIFF'S DEPARTMENT

Page 6 of 6 Continuation

AGENCY IDENTIFIER CA0560000

1 RD 9072	2 BEAT 9G01	3 RB NUMBER 2006-30492
--------------	----------------	---------------------------

4 CODE	5 ITEM	6 QTY.	7 ITEM NAME	8 BRAND / MAKE MANUFACTURER	9 MODEL NAME OR NUMBER	10 MISC. DESCRIPTION	11 IDENTIFICATION / SERIAL NUMBER	12 VALUE
--------	--------	--------	-------------	-----------------------------	------------------------	----------------------	-----------------------------------	----------

████████ explained what actions took place upon arrival to the medical center where the gunshot victim was placed into Room 6 of the Emergency Room and treatment was taken over by the medical center personnel.

████████ had no additional information to add to this interview.

End of report.

13 DATE / TIME OF REPORT 11/15/06/ 7:58 PM	14 REPORTING OFFICER / ID NO. / DIV / UNIT Det. S. Peterson #2238 / Spl. Svcs. <i>SP</i>	15 APPROVED BY / ID NO. <i>BA</i> Sgt. Ayub #3318
---	---	---

NARRATIVE REPORT VENTURA COUNTY SHERIFF'S DEPARTMENT

Page 1 of 2 Continuation

AGENCY IDENTIFIER CA0560000

1 RD 9072	2 BEAT 9G01	3 RB NUMBER 2006-30492
--------------	----------------	---------------------------

4 CODE	5 ITEM	6 QTY	7 ITEM NAME	8 BRAND / MAKE MANUFACTURER	9 MODEL NAME OR NUMBER	10 MISC DESCRIPTION	11 IDENTIFICATION / SERIAL NUMBER	12 VALUE
--------	--------	-------	-------------	-----------------------------	------------------------	---------------------	-----------------------------------	----------

- Supplemental Case Cleared
 Gang Domestic Hate Child Abuse Elderly Abuse

Connecting Report Numbers:

Code Section / Description: 245(c) P.C.

Reclassify to:

Code: V-1 Name: Canley, Adrian



On 11/14/06, at approximately 1840 hours, I arrived at [REDACTED], Thousand Oaks, Ca. I had information that this was the scene of a shooting between Detective Matthews and (S) Adrian Canley. I was asked by Sergeant Powers to interview the firefighters that were still on scene.

I directed the Fire personnel to move their engine out of the crime scene and across Los Feliz Drive to an adjacent driveway. I then interviewed each of the Fire personnel separately. I spoke to Engineer Mark [REDACTED], and digitally recorded our interview. Engineer [REDACTED] said he is currently assigned as the Engineer at Station # 31 (151 Duesenberg Drive, Thousand Oaks). Refer to the CD, and my Supplemental reports for further details.

Engineer [REDACTED] said they had just left a call on the freeway, and told to respond to a shooting victim at [REDACTED]. Fire Dispatch told them to stage until cleared to enter by the Ventura County Sheriff's Department. Once cleared into the scene, he drove to the end of the driveway and saw the paramedics attending to a person on the ground next to a white truck. [REDACTED] parked the engine and went to help the paramedics. When he got to the paramedics, he was told to move the engine so they could use the light from the engine's headlights.

13 DATE / TIME OF REPORT 11-20-06 / 1451	14 REPORTING OFFICER / ID NO / DIV / UNIT Det. J. Smith/#2569/East County M.C.	15 APPROVED BY / ID NO <i>[Signature]</i> / 2486
---	---	---

NARRATIVE REPORT VENTURA COUNTY SHERIFF'S DEPARTMENT

Page 2 of 2 Continuation

AGENCY IDENTIFIER CA0560000

1 RD 9072	2 BEAT 9G01	3 RB NUMBER 2006-30492
--------------	----------------	---------------------------

4 CODE	5 ITEM	6 QTY	7 ITEM NAME	8 BRAND / MAKE MANUFACTURER	9 MODEL NAME OR NUMBER	10 MISC. DESCRIPTION	11 IDENTIFICATION / SERIAL NUMBER	12 VALUE
--------	--------	-------	-------------	-----------------------------	------------------------	----------------------	-----------------------------------	----------

Engineer [REDACTED] then went back to help the paramedics. As they were putting the male subject (later identified as (S) Canley) onto a backboard, one of the paramedics noticed a handgun inside the pants of (S) Canley. They notified the deputies of the handgun and were careful not to touch the handgun as they placed (S) Canley onto a gurney. As the paramedics placed (S) Canley into the ambulance, [REDACTED] said he picked up unused medical supplies that were left at the scene.

I then asked [REDACTED] the condition of (S) Canley when he first got to him. [REDACTED] said (S) Canley was not responsive and they had to give him artificial respirations. I asked [REDACTED] if he knew where the handgun came from, and he did not know. He said he first saw the handgun as it was laying next to (S) Canley's right leg. [REDACTED] could not tell me if the handgun was a revolver or a semi-auto firearm, because he is not familiar with handguns.

I asked [REDACTED] if he noticed anything unusual about the white truck that was next to (S) Canley. He said he did not notice anything about the vehicle.

I then asked [REDACTED] about (S) Canley's clothing. He said when he first saw (S) Canley, he was not wearing a shirt, and the paramedics cut the rest of his clothing off of him. [REDACTED] said this is standard procedure so the paramedics can look for any other injuries. He further said that the clothing was left at the scene. [REDACTED] said he saw several tattoos on (S) Canley's upper front torso.

End of interview.

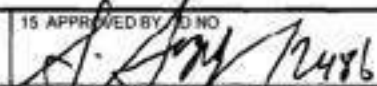
13 DATE / TIME OF REPORT 11-20-06 / 1451	14 REPORTING OFFICER / ID NO / DIV / UNIT Det. J. Smith/#2569/East County M.C.	15 APPROVED BY / ID NO  12486
---	---	---

NARRATIVE REPORT VENTURA COUNTY SHERIFF'S DEPARTMENT

Page 1 of 2 Continuation

AGENCY IDENTIFIER CA0560000

1 RD 9072	2 BEAT 9G01	3 RB NUMBER 2006-30492
--------------	----------------	---------------------------

4 CODE	5 ITEM	6 QTY	7 ITEM NAME	8 BRAND / MAKE MANUFACTURER	9 MODEL NAME OR NUMBER	10 MISC. DESCRIPTION	11 IDENTIFICATION / SERIAL NUMBER	12 VALUE
--------	--------	-------	-------------	-----------------------------	------------------------	----------------------	-----------------------------------	----------

- Supplemental Case Cleared
 Gang Domestic Hate Child Abuse Elderly Abuse

Connecting Report Numbers:

Code Section / Description: 245(c) P.C.

Reclassify to:

Code: S-1 Name: Canley, Adrian



On 11/14/06, at approximately 1840 hours, I arrived at [REDACTED], Thousand Oaks, Ca. I had information that this was the scene of a shooting between Detective Matthews and (S) Adrian Canley. I was asked by Sergeant Powers to interview the firefighters that were still on scene.

I approached the Fire Captain, later identified as: Chad [REDACTED]. I asked Capt. [REDACTED] if I could interview him and his personnel, and he agreed. I directed them to move their engine out of the crime scene and across Los Feliz Drive to an adjacent driveway. I then interviewed each of the Fire personnel separately. I also digitally recorded the interviews. Refer to the CD for details. Refer to my Supplemental reports for further details.

Captain [REDACTED] said he was working overtime tonight as the Captain at Station # 31 (151 Duesenberg Drive, Thousand Oaks). He said his normal work assignment is at the Heliport in Camarillo, Ca.

Prior to arriving at the scene, Capt. [REDACTED] said they were at a traffic accident on the U.S. 101 freeway. They were then dispatched at 1824 hours to a gunshot victim at [REDACTED] [REDACTED] (Fire Incident # 06101562). Capt. [REDACTED] said he was told to stage at the corner of [REDACTED]

13 DATE / TIME OF REPORT 11-20-06 / 1410	14 REPORTING OFFICER / ID NO / DIV / UNIT Det. J. Smith/#2569/East County M.C.	15 APPROVED BY / ID NO <i>J. Smith</i> / 12416
---	---	---

NARRATIVE REPORT VENTURA COUNTY SHERIFF'S DEPARTMENT

Page 2 of 2 Continuation

AGENCY IDENTIFIER CA0560000

1 RD 9072	2 BEAT 9G01	3 RB NUMBER 2006-30492
--------------	----------------	---------------------------

4 CODE	5 ITEM	6 QTY	7 ITEM NAME	8 BRAND / MAKE MANUFACTURER	9 MODEL NAME OR NUMBER	10 MISC. DESCRIPTION	11 IDENTIFICATION / SERIAL NUMBER	12 VALUE
--------	--------	-------	-------------	-----------------------------	------------------------	----------------------	-----------------------------------	----------

Los Feliz Drive and Conejo School Road, and wait for the arrival of deputies from Ventura County Sheriff's Department. As soon as they were cleared to enter the scene, they drove up into the driveway. Capt. [REDACTED] said his paramedic squad then exited the engine and began to render aid to (S) Canley, who was lying on the ground. Capt. [REDACTED] said he saw (S) Canley on the ground adjacent to the driver's side of a white truck, with two uniformed deputies also rendering aid to (S) Canley.

Capt. [REDACTED] said he and his personnel assisted by bringing more medical supplies to the paramedics and also assisted with artificial respirations on (S) Canley. Capt. [REDACTED] said it appeared that (S) Canley was not breathing on his own, and unconscious. Capt. [REDACTED] said once the ambulance arrived, (S) Canley was loaded into the ambulance and transported to Los Robles Hospital. He said his paramedics also went in the ambulance with (S) Canley.

I asked Capt. [REDACTED] if anything unusual occurred during the incident. Capt. [REDACTED] said that they found a weapon (black handgun) inside (S) Canley's pants. He said the paramedics were cutting open (S) Canley's pants, and as they cut open the upper portion of the right pant leg, they found a weapon. They immediately notified the deputies, who instructed them not to move the weapon, but to work around it. Capt. [REDACTED] said the weapon stayed in the pants when they moved (S) Canley onto the gurney. He also added that the rest of (S) Canley's clothes stayed at the scene.

I asked Capt. [REDACTED] if anything else caught his attention at the scene, and he said he did not notice anything else.

End of interview.

13 DATE / TIME OF REPORT 11-20-06 / 1410	14 REPORTING OFFICER / ID NO / DIV / UNIT Det. J. Smith/#2569/East County M.C.	15 APPROVED BY / ID NO <i>A. Joyce</i> / 2486
---	---	--

NARRATIVE REPORT VENTURA COUNTY SHERIFF'S DEPARTMENT

Page 1 of 2 Continuation

AGENCY IDENTIFIER CA0560000

1 RD 9072	2 BEAT 9G01	3 RB NUMBER 2006-30492
--------------	----------------	---------------------------

4 CODE	5 ITEM	6 QTY.	7 ITEM NAME	8 BRAND / MAKE MANUFACTURER	9 MODEL NAME OR NUMBER	10 MISC. DESCRIPTION	11 IDENTIFICATION / SERIAL NUMBER	12 VALUE
--------	--------	--------	-------------	-----------------------------	------------------------	----------------------	-----------------------------------	----------

- Supplemental Case Cleared
 Gang Domestic Hate Child Abuse Elderly Abuse

Connecting Report Numbers:

Code Section / Description: 245(c) P.C.

Reclassify to:

Code: V-1 Name: Canley, Adrian



On 11/14/06, at approximately 1840 hours, I arrived at [REDACTED], Thousand Oaks, Ca. I had information that this was the scene of a shooting between Detective Matthews and (S) Adrian Canley. I was asked by Sergeant Powers to interview the firefighters that were still on scene.

I directed the Fire personnel to move their engine out of the crime scene and across Los Feliz Drive to an adjacent driveway. I then interviewed each of the Fire personnel separately. I spoke to Fire Control Worker [REDACTED] [REDACTED], and digitally recorded our interview. [REDACTED] said he is currently assigned to Camp # 1, located at 2451 Latigo Avenue, Oxnard, Ca. Refer to the CD, and my Supplemental reports for further details.

[REDACTED] said they had just cleared a traffic collision call on the freeway, and were dispatched to a gunshot victim at this location. He said they staged prior to entering the scene, and only entered when they were told it was safe by their dispatcher.

Once the engine was parked, [REDACTED] got off the engine and walked toward the subject (later identified as (S) Canley) as they lay on the ground. [REDACTED] was then told to get a backboard, and he retrieved it from the engine. He went back to (S) Canley and assisted the paramedics in treating (S) Canley.

13 DATE / TIME OF REPORT 11-20-06 / 1931	14 REPORTING OFFICER / ID NO / DIV / UNIT Det. J. Smith/#2569/East County M.C.	15 APPROVED BY / ID NO <i>[Signature]</i> / 2486
---	---	---

NARRATIVE REPORT VENTURA COUNTY SHERIFF'S DEPARTMENT

Page 2 of 2 Continuation

AGENCY IDENTIFIER CA0560000

1 RD 9072	2 BEAT 9G01	3 RB NUMBER 2006-30492
--------------	----------------	---------------------------

4 CODE	5 ITEM	6 QTY.	7 ITEM NAME	8 BRAND / MAKE MANUFACTURER	9 MODEL NAME OR NUMBER	10 MISC. DESCRIPTION	11 IDENTIFICATION / SERIAL NUMBER	12 VALUE
--------	--------	--------	-------------	-----------------------------	------------------------	----------------------	-----------------------------------	----------

He said he did notice an entrance wound in the upper right shoulder area of (S) Canley's torso. [REDACTED] watched as the paramedics turned (S) Canley over to see if there was an exit wound, and he did not see one. [REDACTED] said he noticed a black handgun when the paramedics cut the clothing off of (S) Canley. He said the handgun was inside (S) Canley's pants near his right hip.

I asked [REDACTED] if there was anything else that he noticed when he first arrived at the scene. He said he saw at least one Sheriff's Deputy who informed them it was an officer involved shooting [REDACTED] said he remained at the scene after the paramedics transported (S) Canley to the hospital.

End of Interview

13 DATE / TIME OF REPORT 11-20-06 / 1931	14 REPORTING OFFICER / ID NO / DIV / UNIT Det. J. Smith/#2569/East County M.C.	15 APPROVED BY / ID NO <i>J. Smith</i> / 7486
---	---	--

NARRATIVE REPORT VENTURA COUNTY SHERIFF'S DEPARTMENT

Page 1 of 6 Continuation

AGENCY IDENTIFIER CA0560000

1 PD 9072	2 BEAT 9G01	3 RR NUMBER 2006-30492
--------------	----------------	---------------------------

4 CODE	5 ITEM	6 QTY.	7 ITEM NAME	8 BRAND / MAKE MANUFACTURER	9 MODEL NAME OR NUMBER	10 MISC. DESCRIPTION	11 IDENTIFICATION / SERIAL NUMBER	12 VALUE
--------	--------	--------	-------------	-----------------------------	------------------------	----------------------	-----------------------------------	----------

- Supplemental Case Cleared
- Gang Domestic Hate Child Abuse Elderly Abuse

Connecting Report Numbers:

Code Section / Description: Officer Involved Shooting

Reclassify To:

Code: P Name: Canley, Adrian Doyle

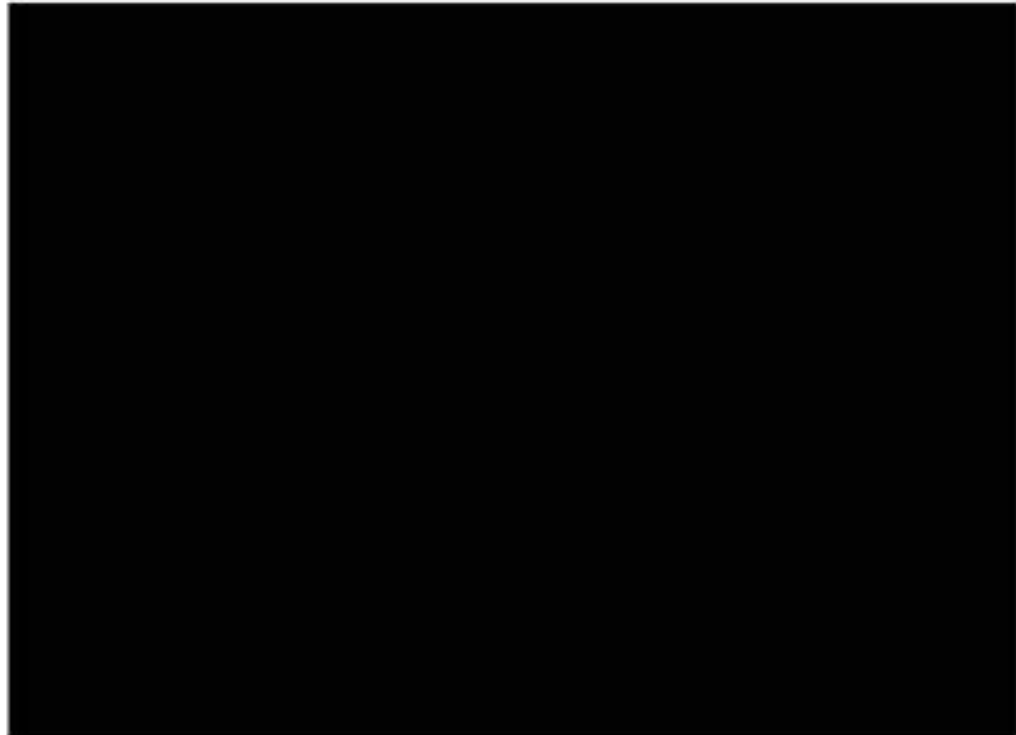

On November 14, 2006, at approximately 2056 hours, I interviewed Firefighter / Paramedic [REDACTED], employed by the Ventura County Fire Department, in the Nurses Lounge at Los Robles Regional Medical Center in the City of Thousand Oaks. This interview was digitally recorded. The following is a summary of the interview. Refer to the CD ROM containing the recording for additional information:

13 DATE / TIME OF REPORT 11/22/06/ 8:09 AM	14 REPORTING OFFICER / IS NO / BA / UNF Det. S. Peterson #2238 / Spl. Svcs.	15 APPROVED BY / IS NO Sgt. Ayub #3318
---	--	---

NARRATIVE REPORT VENTURA COUNTY SHERIFF'S DEPARTMENT

AGENCY IDENTIFIER CA0580000

Page _____ of _____ Continuation

1 RD	2 BEAT	3 RB NUMBER
------	--------	-------------

4 CODE	5 ITEM	6 QTY	7 ITEM NAME	8 BRAND/MAKE MANUFACTURER	9 MODEL NAME OR NUMBER	10 MISC. DESCRIPTION	11 IDENTIFICATION SERIAL NUMBER	12 VALUE
--------	--------	-------	-------------	---------------------------	------------------------	----------------------	---------------------------------	----------

Empty area for narrative report content								
---	--	--	--	--	--	--	--	--

13 DATE/TIME OF REPORT	14 REPORTING OFFICER (ID NO / DIV / UNIT)	15 APPROVED BY (ID NO)
------------------------	---	------------------------

1 RD	2 BEAT	3 RB NUMBER
9072	9G01	06-30492

4 CODE	5 ITEM	6 QTY	7 ITEM NAME	8 BRAND / MAKE MANUFACTURER	9 MODEL NAME OR NUMBER	10 MISC. DESCRIPTION	11 IDENTIFICATION / SERIAL NUMBER	12 VALUE
--------	--------	-------	-------------	-----------------------------	------------------------	----------------------	-----------------------------------	----------

- Supplemental Case Cleared
 Gang Domestic Hate Child Abuse Elderly Abuse

Connecting Report Numbers:

Code Section / Description: Officer Involved Shooting

Reclassify to:

Code: P-1 **Name:** Canley, Adrian

Autopsy

On November 15, 2006 at 0830, I attended the autopsy of Adrian Canley. Dr. Janice Frank the Assistant Chief Medical Examiner for the County of Ventura performed the autopsy. Field Evidence Technician [REDACTED] was also present at the autopsy. She photographed the procedure and collected any evidence that was discovered.

The body was brought into the autopsy room and was contained in a sealed blue vinyl bag. The seal number was 49262. When the bag was opened, I saw Canley's body, which was naked. He had evidence of medical treatment on his body, which included an indo tracheal tube, I.V. lines in his left arm and right upper leg as well as a chest tube in his right side. There was a bloody patch of gauze covering a wound in his upper right shoulder. FET [REDACTED] photographed Canley's body.

FET [REDACTED] brought Canley's clothing to the autopsy. They were collected at the scene by B.I. after they were cut off the victim's body while EMS was treating him. The clothing consisted of the following:

Shoes

- White Nike sport shoes
- White socks

Pants

- Black Levis jeans size 40 waist.

13 DATE / TIME OF REPORT	14 REPORTING OFFICER / ID NO / DIV / UNIT	15 APPROVED BY / ID NO
11-21-06 / 1422	Sgt. S. Rhods/#1438/Special Services	[Signature] 2775

1 RD	2 BEAT	3 RB NUMBER
9072	9G01	06-30492

4 CODE	5 ITEM	6 QTY	7 ITEM NAME	8 BRAND / MAKE MANUFACTURER	9 MODEL NAME OR NUMBER	10 MISC DESCRIPTION	11 IDENTIFICATION / SERIAL NUMBER	12 VALUE
--------	--------	-------	-------------	-----------------------------	------------------------	---------------------	-----------------------------------	----------

The pants had been cut up both legs and there was soil on the seat and lower left leg.

A black leather belt was in the evidence bag but not attached to the pants.

Shirts

Black hooded pullover sweatshirt.

The "Kangaroo" pocket was empty. The sweatshirt had been cut off the victim. There was a ragged hole in the right shoulder area that measured approximately 1 centimeter in diameter.

A bullet "jacket" was embedded in the fabric of the sweatshirt approximately 1^{1/2} inch above the neck seam of the sweatshirt. (FET ██████ collected this item as evidence).

Gray long-sleeved Tee shirt

The gray long-sleeved Tee shirt had been cut from the victim's body. There was a ragged hole in the right shoulder approximately 3 inches below the top of the shoulder. This hole was surrounded by blood.

White Tee shirt

The white Tee shirt had a ragged hole in the upper right shoulder that was approximately 3 inches below the neckline. This hole was surrounded by blood.

White Tank Top

The white tank top was cut from the body. In the right shoulder loop was a ragged hole that measured 1.5 centimeter.

Canley is an adult male of about █████ years of age. His head was shaved clean. There were numerous tattoos on his chest that primarily illustrated ██████ Some profanities are

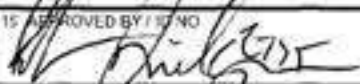
13 DATE / TIME OF REPORT	14 REPORTING OFFICER / ID NO / DIV / UNIT	15 APPROVED BY / ID NO
11-21-06 / 1422	Sgt. S. Rhods/#1438/Special Services	

NARRATIVE REPORT VENTURA COUNTY SHERIFF'S DEPARTMENT

Page 3 of 4 Continuation

AGENCY IDENTIFIER CA0560000

1 RD 9072	2 BEAT 9G01	3 RB NUMBER 06-30492
---------------------	-----------------------	--------------------------------

4 CODE	5 ITEM	6 QTY	7 ITEM NAME	8 BRAND / MAKE MANUFACTURER	9 MODEL NAME OR NUMBER	10 MISC DESCRIPTION	11 IDENTIFICATION / SERIAL NUMBER	12 VALUE
--------	--------	-------	-------------	-----------------------------	------------------------	---------------------	-----------------------------------	----------

inscribed at the bottom. On the upper abdomen is another tattoo that depicts praying hands and the names Francisco Escobar and Gustavo. On the back of his neck is the tattoo [REDACTED]

Injuries

A small red abrasion is present on the victim's forehead. It is dried and its age is undetermined.

No other injuries are evident on the body except the gunshot wounds that are described below.

Gunshot Wound

The entry wound is to the right front shoulder. It is 11 – 12 inches below the top of the head. It is also 3 inches below the top of the right shoulder and 3 inches to the right of the midline of the body.

There is a gray deposit on the exposed soft tissue of the skin. The wound is slightly elongated. Refer to Dr. Franks report for dimensions of this wound.

The victim was rolled over onto his face and the bullet could be palpated through the skin under the right shoulder. Dr. Frank excised the skin of the upper back and removed a large and intact bullet that measured 1 centimeter across its base. There was soft tissue and bone imbedded in the bullet. (FET [REDACTED] took this bullet as evidence.)

Dr. Frank determined that the path of the bullet was front to back "Very" slightly upward and "Very" slightly left to right. After entering the upper right, shoulder Dr. Frank concluded the bullet struck just below the clavicle, grazed some blood

13 DATE / TIME OF REPORT 11-21-06 / 1422	14 REPORTING OFFICER / ID NO. / DIV / UNIT Sgt. S. Rhods/#1438/Special Services	15 APPROVED BY / ID NO. 
--	---	--

NARRATIVE REPORT VENTURA COUNTY SHERIFF'S DEPARTMENT

Page 4 of 4

Continuation

AGENCY IDENTIFIER CA0560000

1 RD	2 BEAT	3 RB NUMBER
9072	9G01	06-30492

4 CODE	5 ITEM	6 QTY.	7 ITEM NAME	8 BRAND / MAKE MANUFACTURER	9 MODEL NAME OR NUMBER	10 MISC. DESCRIPTION	11 IDENTIFICATION / SERIAL NUMBER	12 VALUE
--------	--------	--------	-------------	-----------------------------	------------------------	----------------------	-----------------------------------	----------

vessels in the rib cage, grazed the upper lobe of the right lung, and lodged in the upper right back.

Gunshot Wound to Hand

There were two wounds on Canley's left hand. He had a laceration across the left index finger at the first knuckle that measured 1.5 centimeters. He also had a laceration to the tip of his right thumb that tore the thumbnail free. This injury measured 1 centimeter in length.

Dr. Frank completed the rest of her examination of Canley and determined the cause of death to be "Gunshot wound to the chest." The manner of death is "Homicide."

For complete details of this autopsy, refer to the report by Dr. Frank.

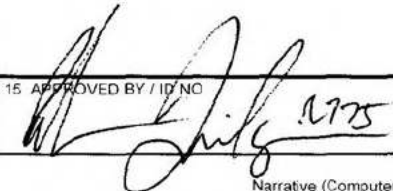
13 DATE / TIME OF REPORT	14 REPORTING OFFICER / ID NO / DIV / UNIT	15 APPROVED BY / ID NO
11-21-06 / 1422	Sgt. S. Rhods/#1438/Special Services	 1175

MEDICAL EXAMINER-CORONER

COUNTY OF VENTURA

AUTOPSY REPORT

CANLEY, ADRIAN

1664-06

PERFORMED BY: Janice G. Frank, M.D.
PERFORMED AT: Ventura County Medical Examiner's Office
DATE: November 15, 2006
TIME: 8:30 a.m.

WITNESSES: Ventura County Sheriff's Department Detective Steve Rhods
and B.I. [REDACTED]

CAUSE OF DEATH: GUNSHOT WOUND OF CHEST

MANNER OF DEATH: HOMICIDE

AUTOPSY FINDINGS:

- I. Gunshot wound of chest
 - A. Entrance – right upper anterior chest
 - B. Path – perforates soft tissue, chest wall through second rib, grazes upper lobe of right lung, perforates right posterior third rib
 - C. Exit – none
 - D. Bullet – a large caliber projectile recovered from soft tissue, right upper back
 - E. Direction-of-fire – front-to-back, very slightly upward and very slightly right-to-left
 - F. Right hemothorax (1800 cc.)
 - G. Right subpleural hemorrhage

- II. Gunshot wound of left hand
 - A. Entrance – right index finger to pad of right thumb
 - B. Path – passes through soft tissue
 - C. Exit – anterior tip of right thumb beneath nail

- III. Pulmonary anthracosis

GENERAL DESCRIPTION:

The body is received in a blue vinyl pouch, with a medical examiner's tag attached to the zipper and inscribed with the decedent's name. The pouch is locked with seal #49262. A small bloodstained towel is under the head.

CLOTHING:

The following items are received in sheriff evidence bags:

1. In the first bag is a pair of white "Nike" sports shoes, two white socks with black toes and heels, and an intact black belt, with a white metal buckle.
2. A second bag contains a very heavy black hooded pull over sweatshirt. The kangaroo pocket in the front is empty. It has been cut from the body and the fabric feels slightly damp. A ragged hole is in the right upper front of the shirt and is located approximately 2 ½" below the seam where the hood is attached on the right front, and measures approximately 1 cm. in diameter. On the front of the hood, located approximately 1 ½" above the attachment seam and 1 ¼" from the front edge of the hood, is a 0.6 cm. fragment of copper metal, consistent with bullet jacketing. The edge of the jacketing has penetrated the fabric for a short distance.
3. The third bag contains black jeans that are partially wrapped in white butcher paper. The jeans have been cut from the body up the front of the legs and across the waistband. There is a small amount of soil on the seat and on the left lower back leg of the jeans. The jeans are "Levi" brand, 40 waist and 32 length.
4. The fourth bag contains three shirts. The first is a gray long sleeve knit shirt, which has been cut from the body. There is heavy bloodstaining on the right upper front that surrounds a ragged defect, which measures approximately 1.5 cm. in diameter. The defect is located approximately 3" below the neckband. The second shirt is a white "Hanes" brand tee shirt, which is discolored light yellow in many areas. There is some brown soil on the back and right lower side of the shirt. An area of heavy bloodstaining is on the right upper front, surrounding a ragged defect in the fabric, which measures approximately 1.2 cm. in diameter. The defect is located approximately 3" below the top of the neckband. A third shirt consists of a white rib-knit tanktop-style undershirt, which is discolored light yellow. There is bloodstaining on the front. The shirt has been cut across the shoulder straps. On the right shoulder strap, approximately ¾" above the cut is a roughly round defect, which measures approximately 1.5 cm. in maximum diameter.

EVIDENCE OF MEDICAL THERAPY:

1. An endotracheal tube is strapped in the mouth. A surgical glove is attached to the end of the tube.
2. A dressing is on the right upper anterior chest, covering a gunshot wound to be described below.
3. A right chest tube is in place.
4. A vascular line is in the right groin.
5. A hospital identification band about the left wrist is imprinted with the name "John Doe"
6. A vascular line is in the left antecubital fossa.
7. A bandaid is over the left deltoid area.

EXTERNAL EXAMINATION:

The body is that of a well-developed, well-nourished male, whose appearance is consistent with the recorded age of 25 years. The length is 68 ¼" and the weight is 153 pounds. The body has not been embalmed and is well preserved. Rigidity is well developed in the extremities, and lividity is posterior and blanches slightly with firm finger pressure. The body has been refrigerated and is cool to the touch.

The scalp is shaved. The corneas are clear, and the irides are brown. The conjunctivae are pale and without petechial hemorrhage. There is mild drying artifact across the corneas. The nose is intact, without secretions. The lips are intact and the teeth are natural and in a good state of repair. There is no blood in the mouth. A 0.5 cm. black moustache and 1 cm. soul patch are on the face. The remainder of the beard area is covered by very short stubble. The ears are normally formed, with a pierce hole in each earlobe. The neck is straight and symmetrical and the trachea is midline.

The chest is symmetrical and the breasts are those of a normal adult male. A complex tattoo involves the chest, extending to the top of the shoulders and below the nipples. The tattoo is composed of the words [REDACTED] and the words [REDACTED]. The abdomen is flat, without palpable organomegaly. On the abdomen, extending from above the ribs and costal margin, down to the umbilicus is another complex tattoo which contains praying hands, crosses and the words [REDACTED] and two names on banners over each cross that read [REDACTED] and [REDACTED]. There are also spiders and webs in this tattoo. The genitals are those of a normal circumcised adult male, with the testicles bilaterally descended into the scrotum.

The arms and hands are normally formed. The nailbeds are cyanotic and the fingernails do not extend to the fingertips. There is soil beneath the fingernails. Scattered round hyperpigmented scars are on the arms, involving the upper and lower arms and dorsal surfaces of the wrist and hands. Most of these scars measure approximately 1 cm. in diameter. There are no definite needle tracks or needle marks, aside from therapeutic needle marks. There are no tattoos. The legs are normally formed, without angularity or edema. Scattered hyperpigmented round scars are on the thighs; the largest of these measures 1.5 cm. in diameter. A healing abrasion is on the right anterior tibial area and measures 1.5 cm. The feet and toenails are unremarkable, with some soil beneath the toenails.

The back is straight and symmetrical and the anus is without injury. Some acne scars are on the back. A tattoo is on the upper back, just below the neck that reads [REDACTED]

EVIDENCE OF INJURY:

GUNSHOT WOUND OF CHEST:

Entrance – On the right upper anterior chest, centered approximately 13" from the top of the head, 3 ½" from the top of the right shoulder, and 3 ½" to the right of anterior midline, is a gunshot entrance wound which measures approximately 1.2 cm. in diameter. There is asymmetric marginal abrasion around the wound, which is widest from the 1 o'clock around to the 7 o'clock position, and in these areas measures up to 0.5 cm. in width. From the 7 o'clock to the 12 o'clock position the abrasion is narrow, measuring no more than 0.1 cm. in width. There is some gray deposit at the superior side of the wound on the exposed soft tissue.

Path – After perforating skin and subcutaneous soft tissue of the right upper anterior chest, the bullet passes through muscle of the chest wall beneath the clavicle, and enters the right thoracic cavity through the anterolateral first rib, producing fragmentation of the rib and laceration of vessels adjacent to the rib. The subclavian vessels are intact to probe. The bullet then grazes the upper lobe of the right lung and exits the right thoracic cavity through the third rib, producing fragmentation of the bone and laceration of vessels adjacent to these ribs. The bullet then lodges in the right upper back as described below.

Accompanying this gunshot wound is approximately 1800 cc. of liquid and clotted blood in the right thoracic cavity, along with extensive subpleural hemorrhage in the area of both the thoracic entrance and exit.

Exit – None.

Bullet – On the right upper back, just medial to the scapula, centered approximately 11" to 12" below the top of the head, 3" below the top of the right shoulder, and 3" to the right of

posterior midline, a bullet is palpable underneath the skin. Incision in the area reveals a hematoma and a large caliber partially jacketed deformed projectile is recovered from soft tissue. The projectile measures approximately 1 cm. across the diameter of the base.

Direction-of-fire – The bullet passes from front-to-back, very slightly upward and very slightly right-to-left.

GUNSHOT WOUND OF LEFT HAND:

Two adjacent wounds on the left hand were likely produced by the same bullet. There is a superficial linear laceration on the middle phalanx of the left index finger, which measures approximately 1.5 cm. With the hand in the anatomic position this aligns with a laceration in the tip of the left thumb. The main portion of the laceration is 1 cm. in length. The nail of the thumb has been partially torn free. The bones of these fingers are intact.

OTHER INJURIES:

A dry red abrasion on the mid-forehead, below the hairline, measuring 0.3 cm. in maximum size.

INTERNAL EXAMINATION:

The body is opened through an abdominal fat layer of 1-2 cm. and a muscle layer of 1 cm. The internal organs are found in their normal positions and are covered by glistening serosal surfaces. 1800 cc. of liquid and clotted blood are in the right thoracic cavity. There is no abnormal accumulation left chest cavity, pericardial sac, or abdominal cavity fluid or blood. The right chest tube enters the thoracic cavity through the seventh intercostal space and is lying free within the chest cavity. Internal injury has been described.

SYSTEMS REVIEW:

CARDIOVASCULAR SYSTEM: The heart weighs 360 grams and is covered by glistening epicardium, with a moderate amount of epicardial fat. The coronary arteries arise normally and follow a right-dominant course, without atherosclerosis. Sections of the myocardium are firm, red-brown and finely fibrillar, without evidence of recent or old ischemic injury. The heart is lined by glistening endocardium. The cardiac valves have their normal structure and the leaflets are thin and translucent, without calcification or vegetations. The coronary ostia are patent. The aorta follows a normal course through the chest and into the abdomen, and exhibits no atherosclerosis or injuries. Blood vessels contain small quantities of liquid blood.

RESPIRATORY SYSTEM: The right and left lungs together weigh 480 grams. Both are covered by glistening tan to purple pleural surfaces, with moderate quantities of subpleural anthracotic pigment deposition. The bronchi are patent and are lined by tan mucosa. The bronchi of the right lung are coated with blood and injury to the right lung has been described. There are no pulmonary thromboemboli. Cut surfaces of the lungs are atelectatic and congested in dependent areas. There is hemorrhage in the area of the graze wound of the upper lobe of the right lung. There are no areas of consolidation or other focal lesions.

HEPATOBIILIARY SYSTEM: The liver weighs 1250 grams and is covered by a glistening red-brown capsule. Cut surfaces are firm and red-brown, without lesions. The bile ducts are patent and the gallbladder contains approximately 3 cc. of bile and no stones.

GASTROINTESTINAL SYSTEM: The intact esophagus is lined by tan mucosa. The stomach contains approximately 100 cc. of thick partially digested food. Medication particles are not identified. The gastric mucosa is unremarkable. The pylorus is patent and the duodenal contents are bile-stained. The remainder of the small intestine and large intestine are normal to inspection and palpation. The appendix is normal.

The pancreas is of normal size and shape, and cut surfaces are tan and lobulated, without lesions.

HEMATOPOIETIC SYSTEM: The spleen weighs 130 grams and is covered by a glistening purple capsule. Cut surfaces are firm, with well-maintained white pulp areas. Lymph nodes within the neck, chest and abdomen are unremarkable. The thymus is minimally replaced by fat.

GENITOURINARY SYSTEM: The right and left kidneys together weigh 220 grams. The capsules strip with ease from both, revealing glistening light purple cortical surfaces. Cut surfaces show clear demarcation between cortical and medullary areas. The renal calyces and pelves are not dilated and drain into ureters of normal caliber, which follow a normal course to the urinary bladder. The bladder contains approximately 100 cc. of clear yellow urine, and is lined by unremarkable tan mucosa. The prostate is normal to sectioning. The testicles are normal to palpation within the scrotum.

ENDOCRINE SYSTEM: The thyroid is of normal size and shape, and cut surfaces are light maroon and finely lobulated, without lesions. The adrenal glands are of normal size and shape, and cut surfaces show unremarkable golden cortical and maroon medullary areas. The pituitary is normal.

NECK: There is no hemorrhage within the strap muscles, thyroid or posterior pharyngeal constrictors. The bony and cartilaginous structures of the larynx, and the hyoid bone, are intact.

The larynx and trachea are patent and are lined by tan mucosa, which is coated with a small amount of tan foam and blood. There is no abnormal mobility or crepitation of the cervical vertebrae.

MUSCULOSKELETAL SYSTEM: The muscles are normally developed and consistent with those of an adult male. The skeleton is normally developed and consistent with that of an adult male. Rib fractures have been described.

HEAD: Reflection of the scalp reveals no subgaleal hemorrhage. The calvarium is intact. There is no epidural or subdural hemorrhage. Removal of the dura from the base of the skull reveals no hemorrhage or fractures. The pituitary and proximal spinal cord are intact.

CENTRAL NERVOUS SYSTEM: The fresh brain weighs 1530 grams and is covered by glistening transparent leptomeninges. The gyri are normally oriented and exhibit no significant flattening. Examination of the base of the brain reveals an intact circle of Willis, without atherosclerosis or aneurysms. The cranial nerves are intact. There is no uncus or cerebellar tonsillar herniation. There is no subarachnoid hemorrhage. The brainstem and cerebellum have their normal external appearance.

Sections of the cerebral hemispheres reveal an intact cortical ribbon and underlying white matter. The basal ganglia and thalami have their normal appearance. The ventricles are not dilated and are lined by glistening ependyma, without intraventricular hemorrhage. Sections of the brainstem and cerebellum reveal an intact internal structure. The spinal cord is not removed.

TOXICOLOGY: Specimens of right chest cavity blood, urine, and gastric content are retained. Admitting blood is also retained. Spots of blood are placed on two FTA cards.

HISTOLOGY: Representative tissues are retained.

PHOTOGRAPHS: 35 mm. photographs are obtained.

X-RAYS: Multiple hospital x-rays are available for examination.

EVIDENCE: All clothing, the recovered projectile, an FTA card and multiple photographs are obtained by sheriff's B.I.

JGF/jc



Janice G. Frank, M.D.
Assistant Medical Examiner

J



COUNTY OF VENTURA SHERIFF'S DEPARTMENT

800 S. VICTORIA AVENUE VENTURA, CA 93009 (805) 654-2370

FORENSIC SCIENCES LABORATORY REPORT

TOXICOLOGY SECTION

LAB CASE NUMBER:
L06-6802-1

entered by SG

SUBJECT(S): CANLEY, ADRIAN (D)	
AGENCY: MEDICAL EXAMINER	
AGENCY CASE NUMBER: MISC1664-06	OFFENSE(S): DEATH

SUPPLEMENTAL REPORT

The following items were received for analysis by the crime laboratory on 11/15/2006 4:46:00 PM.

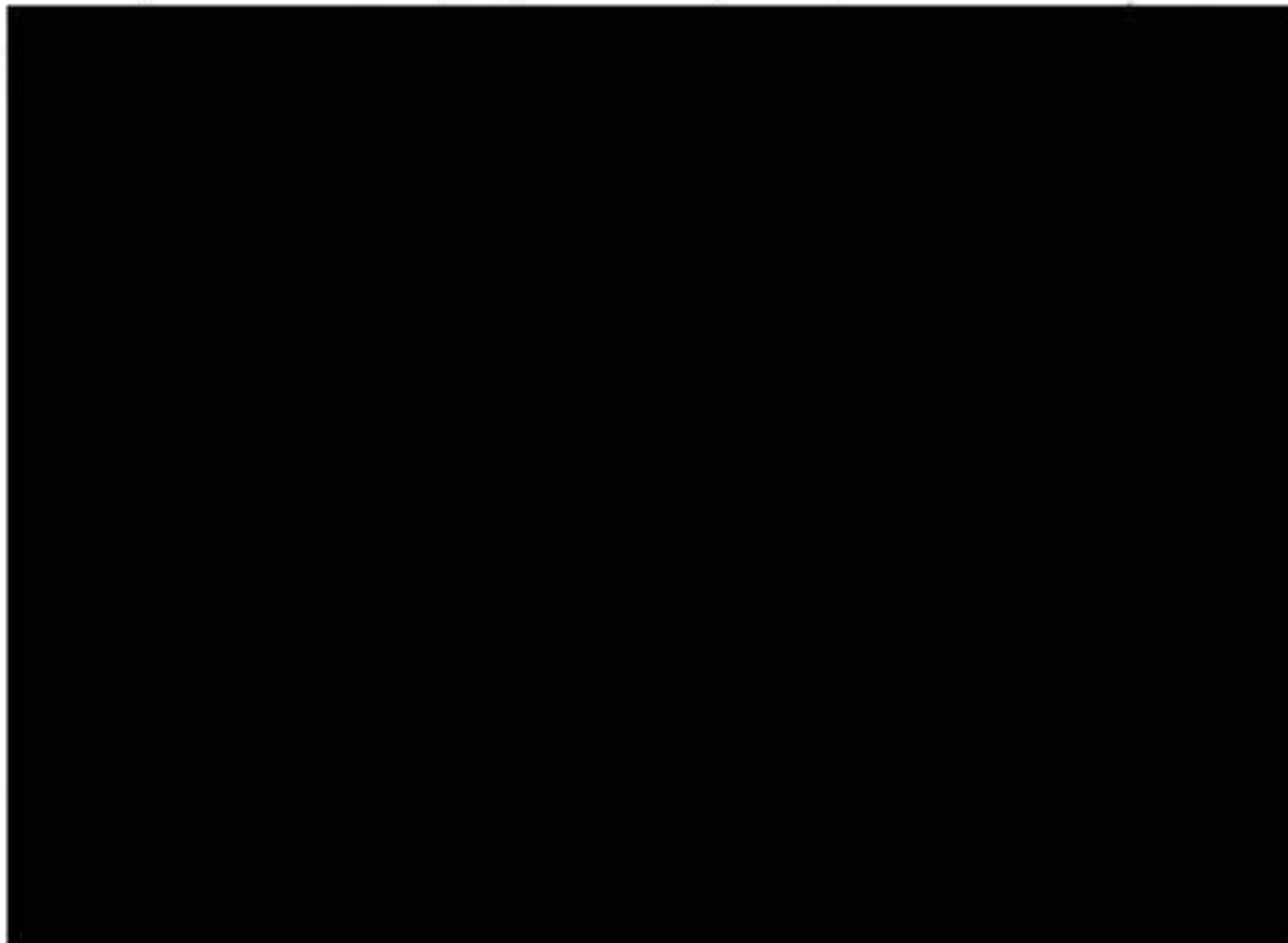

QF

VENTURA COUNTY SHERIFF'S FORENSIC SCIENCES LABORATORY REPORT

TOXICOLOGY SECTION

L06-6802-1

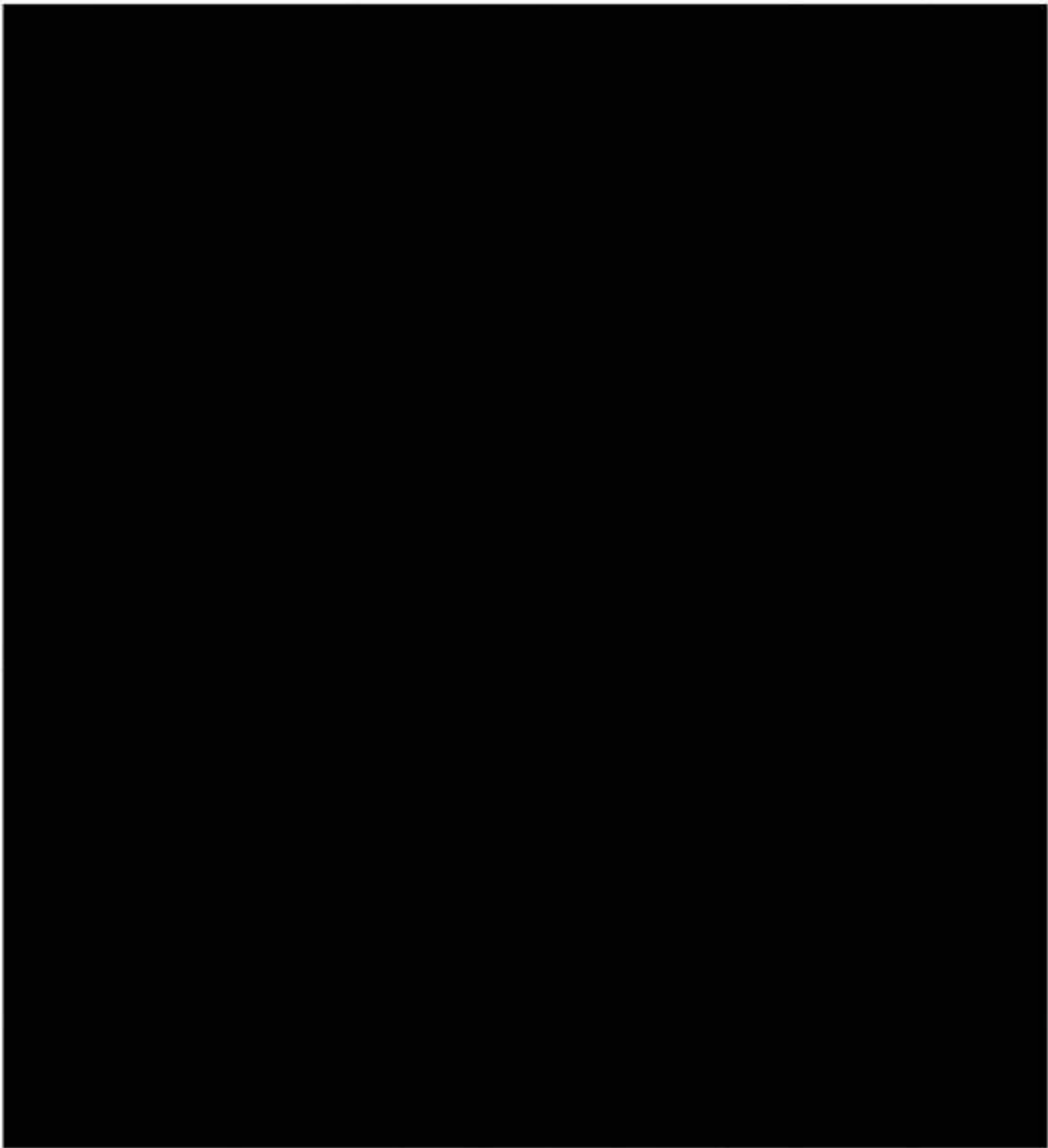

QF

VENTURA COUNTY SHERIFF'S FORENSIC SCIENCES LABORATORY REPORT

TOXICOLOGY SECTION

L06-6802-1



SCOTT COLLEY
FORENSIC SCIENTIST

CF



COUNTY OF VENTURA SHERIFF'S DEPARTMENT

800 S. VICTORIA AVENUE VENTURA, CA 93009 (805) 654-2370
FORENSIC SCIENCES LABORATORY REPORT

FORENSIC ALCOHOL SECTION

LAB CASE NUMBER:
L06-6802-1

SUBJECT(S): CANLEY, ADRIAN (D)	
AGENCY: MEDICAL EXAMINER	DATE OF ARREST: 11/15/2006
AGENCY CASE NUMBER: MISC1664-06	OFFENSE(S): DEATH

FINAL REPORT

The following items were received for analysis by the crime laboratory on 11/15/2006 4:46:00 PM.

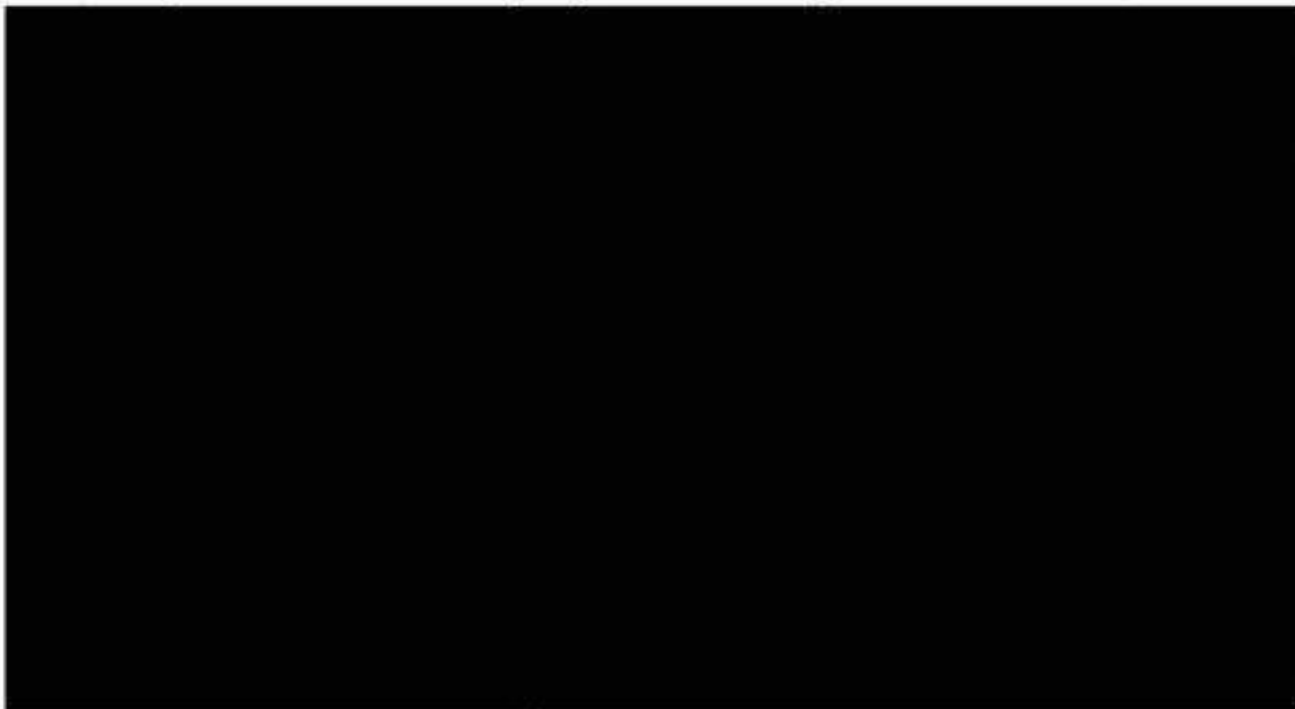

Handwritten initials or signature.

VENTURA COUNTY SHERIFF'S FORENSIC SCIENCES LABORATORY REPORT

FORENSIC ALCOHOL SECTION

L06-6802-1

The following items were received for analysis by the crime laboratory on 12/11/2006 10:23:00 AM.



██████████
FORENSIC ALCOHOL SUPERVISOR

AF



Decedent Name: Adrian Doyle Canley
Also Known As:

Place of Death: Los Robles RMC ER
Manner of Death: Homicide
Cause of Death: Gunshot wound of chest
Due to:
Due to:
Due to:
Other Significant Conditions: None

Death Date: 11/14/2006
Death Time: 20:13:00
Property: None
Autopsy by: Dr. Frank
Investigator: Craig Stevens

SUMMARY OF INVESTIGATION

On 11/14/2006, at about 2021 hours, Sgt. M. Powers from the Ventura County Sheriff's Department Major Crimes Unit contacted me. He reported the death of Adrian Doyle Canley. He advised that the death was the result of an officer-involved shooting incident in the City of Thousand Oaks.

Sgt. Powers related the following information based on the preliminary investigation. At about 1815 hours this date, a plain clothes detective was conducting a follow-up investigation into a non-violent crime completely unrelated to the decedent. While the detective was interviewing a male subject in the small parking lot of an apartment complex, the decedent approached the detective on foot. The decedent appeared to be in an agitated state and asked the detective if he was a police officer. The detective acknowledged that he was, and the decedent walked away and got into a white Ford pick-up truck that was parked near-by. For unknown reasons, the decedent started to drive the pick-up truck towards the detective. The detective shouted at the decedent to stop numerous times and then fired his service pistol at the decedent. The decedent was shot in the right shoulder and the truck came to a stop in the parking lot.

The detective called for assistance and emergency medical personnel and started first aid. The decedent was found to be carrying a loaded handgun in the waistband of his pants. The decedent was transported to the Los Robles Regional Medical Center Emergency Room in Thousand Oaks by paramedic ambulance from the American Medical Response Ambulance Service. Sgt. Powers advised that the decedent had been pronounced at the ER at about 2013 hours. Sgt. Powers requested that I meet Detective S. Peterson at the hospital. I responded at about 2030 hours and arrived at about 2052 hours.

At the hospital, I spoke to Detective Peterson. He related the same basic information as received from Sgt. Powers. After photographing the body, I examined the decedent. The body was that of a Hispanic male adult whose appearance was consistent with the stated age of. The body was supine on a backboard on the gurney. The body was warm to the touch and was absent of rigor.

Signature: 
Craig Stevens, Deputy Medical Examiner



Mild blanching lividity was present and consistent with the position of the body. The visible trauma consisted of an entry wound to the right shoulder area and minor injuries to the left thumb and forefinger. There was no exit wound. Also visible on the arms and legs were numerous scars. The decedent's chest was covered in elaborate gang-related tattoos.

Evidence of medical treatment included an endotracheal tube, chest tube on the right side of the chest, an IV line in the left antecubital fossa and a triple lumen IV line in the right groin area.

The temperature of the trauma room was about 75° at about 2114 hours. The decedent's core body temperature was 97° at about 2124 hours.

Members of the Ventura County Sheriff's Department Crime Scene Investigation team arrived and photographed the decedent and performed gunshot residue tests of the decedent's hands.

The body was placed into a blue body bag and seal number 29262 was placed at about 2222 hours. The body was transported to the Ventura County Medical Examiner's Office by Cathedral Mortuary Associates pending notification of the next-of-kin and a review of the case with the Medical Examiner.

I responded to the scene with Detective Peterson. I spoke to Sgt. M. De Los Santos of the Ventura County Sheriff's Department. He stated that deputies had responded to an address in Oxnard that had been provided by the decedent's probation officer. He advised that the address was no longer valid as the decedent did not live there. No other information was available on the decedent's place of residence.

On 11/15/2006, I was advised by Sgt. S. Rhods that he had been contacted by the Santa Paula Police Department and had been told that the decedent's mother was staying at a residence on East [REDACTED] in the City of Santa Paula. He advised that the family had filed a report on the decedent on 11/14/2006. The report stated that the decedent had left the Santa Paula home at about 1725 hours and that the decedent had been seen carrying what appeared to be handgun in the waistband of his pants. The decedent was seen driving a white 1999 Ford F-150 pick-up truck, California license [REDACTED]. This was the same vehicle that the decedent attempted to run over the detective with.

I contacted Lt. M. Saviers of the Santa Paula Police Department. He confirmed that the decedent's mother, Mrs. [REDACTED] Canley was at the [REDACTED] address. He stated that she had been visiting from New York for the past several weeks. I responded to the Santa Paula Police Department and Lt. Saviers and I went to the residence. At about 0838 hours, I informed Mrs. Canley of the death and the known circumstances surrounding the incident. Mrs. Canley stated that the decedent had been experiencing increasing paranoia since August of 2005. She stated that the decedent had made statements that people were watching him and after him. She stated that the

Signature

Handwritten signature of Craig Stevens in cursive script.
Craig Stevens, Deputy Medical Examiner



decedent's paranoia had reached a point that even school children walking past the house upset the decedent if they looked his direction. I asked her if she knew a reason for the decedent going to the Thousand Oaks area, and she stated that the decedent had friends there. She also confirmed that the decedent had a known history of drug abuse. I explained the procedures that would follow.

On 11/15/2006, I reviewed the case with Janice G. Frank, M.D., Assistant Chief Medical Examiner for the County of Ventura. She advised that an autopsy would be conducted. At the conclusion of the procedure, Dr. Frank advised that the cause of death was a gunshot wound of the chest. The manner of death was ruled a homicide.

The body was released to the Skillin Mortuary in Santa Paula at the request of the family.

Signature: _____

Craig L. Stevens
Craig Stevens, Deputy Medical Examiner

SW-523-06
FILED
DEC 12 2006
MICHAEL D. PULLEN
EXECUTIVE CLERK

1
2
3
4
5
6
7
8
9
10
11
12
13
14
15
16
17
18
19
20
21
22
23
24
25
26
27
28

STATE OF CALIFORNIA - COUNTY OF VENTURA
RETURN TO SEARCH WARRANT

Ventura County Sheriff's Detective Sergeant William Ayub swears under oath that he conducted a search pursuant to the below described search warrant:

- Issuing Magistrate: Honorable Rebecca Riley
- Magistrate's Court: Superior Court, Ventura Judicial District
- Date of Issuance: November 16, 2006
- Date of Service: November 16, 2006

and searched the following location(s), person(s), and vehicle(s):

A white 1999 Ford F-150 pickup truck, bearing California license number [REDACTED] and Vehicle Identification Number [REDACTED] which is presently in the custody of the Ventura County Sheriff's Department at a secure storage facility, including all contents and containers within the vehicle

and seized the items described below:

See attached and incorporated property inventory.

He further swears that this is a true and detailed account of all property taken by him pursuant to the search warrant, and

1 that pursuant to penal code sections 1528 and 1536 this property
2 will be retained in his custody, subject to the order of this
3 court or of any other court in which the offense in respect to
4 which the seized property is triable.

5
6 Willie J. Coy

7 Signature of Affiant

8
9 SWORN TO AND SUBSCRIBED BEFORE ME THIS
10 12 DAY OF December, 2006.

11
12 Theresa Orsted

13 Signature
14 Clerk of the Superior Court,
15 Ventura Judicial District
16
17
18
19
20
21
22
23
24
25
26
27
28

1 **SEALING ORDER**

2
3 The Court has read and considered the search warrant
4 affidavit submitted by Detective Sergeant William Ayub of the
5 Ventura County Sheriff's Department. The Court makes the
6 following factual findings pursuant to California Rules of Court
7 243.1:

8 There exists an overriding interest in protecting the
9 record that overcomes the right of the public access to the
10 record;

11 The overriding interest supports sealing the record;
12 A substantial probability exists that the overriding interest
13 will be prejudiced if the record is not sealed;
14 The proposed sealing is narrowly tailored;
15 No less restrictive means exist to achieve the overriding
16 interest.

17 It is hereby ordered that the search warrant, search
18 warrant return and affidavit remain sealed by order of this
19 court until such a time as the Court directs otherwise. The
20 said placement order and affidavit may not be released without
21 further order of this court.

22 This order has been requested by the search warrant affiant
23 pursuant to Evidence Code section 1040 et.seq., as well as
24 California Rules of Court section 243.1.

25
26 11-16-06

27 Date

25
26 

27 Judge of the Superior Court
28 Ventura Judicial District

1
2
3
4
5
6
7
8
9
10
11
12
13
14
15
16
17
18
19
20
21
22
23
24
25
26
27
28

STATE OF CALIFORNIA – COUNTY OF VENTURA
SEARCH WARRANT AND AFFIDAVIT
(DISTRICT ATTORNEY REVIEW)

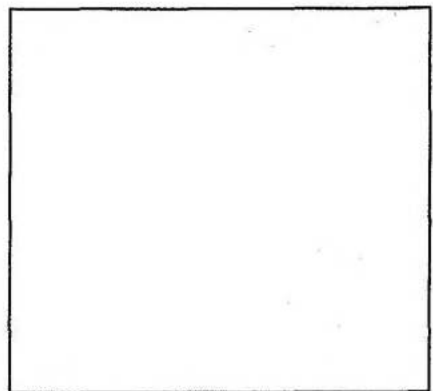

The Attached warrant and affidavit have been reviewed for legal sufficiency by the undersigned Deputy District Attorney. The contents if sworn to by the affiant, are legally sufficient to justify presenting the affidavit and warrant to a court for review. This document consists of 14 pages, including the search warrant, statement of probable cause, ~~and~~ this review form *and two page sealing order.*

Stacy Ratner
Deputy District Attorney (PRINT NAME)

Deputy District Attorney (SIGNATURE)

Date: 11/16/06

1
2
3
4
5
6
7
8
9
10
11
12
13
14
15
16
17
18
19
20
21
22
23
24
25
26
27
28

STATE OF CALIFORNIA – COUNTY OF VENTURA
SEARCH WARRANT AND AFFIDAVIT
(AFFIDAVIT)

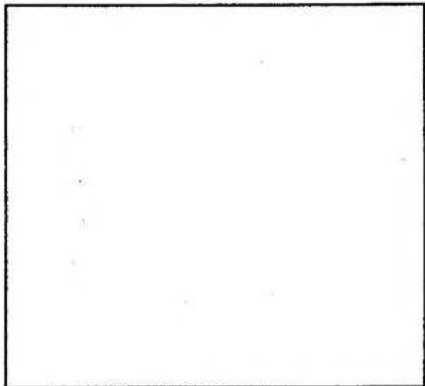

Ventura County Sheriff's Detective Sergeant William Ayub swears under oath that the facts expressed by him in the attached and incorporated Statement of Probable Cause are true and that based thereon he has probable cause to believe and does believe that the property described below is lawfully seizable pursuant to Penal Code Section 1524, as indicated below, and is now located at the locations set forth below. Wherefore, affiant requests that this Search Warrant be issued.

William F. Ayub

, NIGHT SEARCH REQUESTED: YES NO

SIGNATURE OF AFFIANT

(SEARCH WARRANT)

THE PEOPLE OF THE STATE OF CALIFORNIA TO ANY SHERIFF, POLICEMAN OR PEACE OFFICER IN THE COUNTY OF VENTURA: Proof by affidavit having been made before me by Detective Sergeant William Ayub, that there is probable cause to believe that the property described herein may be found at the locations set forth herein and that it is lawfully seizable pursuant to Penal Code Section 1524 as indicated below by "X" (s) in that it:

- was stolen or embezzled;
- was used as the means of committing a felony;

- 1 is possessed by a person with the intent to use it as means
2 of committing a public offense or is possessed by another to
3 whom he or she may have delivered it for the purpose of
4 concealing it or preventing its discovery;
- 5 tends to show that a felony has been committed or that a
6 particular person has committed a felony;
- 7 tends to show that sexual exploitation of a child, in
8 violation of P.C. Section 311.3, has occurred or is
9 occurring;
- 10 an arrest warrant has been issued for _____;
- 11 a provider of electronic communication service or remote
12 computing service has records or evidence, as specified in
13 Penal Code Section 1524.3, showing that property was stolen
14 or embezzled constituting a misdemeanor, or that property or
15 things are in possession of any person with the intent to use
16 them as a means of committing a misdemeanor public offense,
17 or in the possession of another to whom he or she may have
18 delivered them for the purpose of concealing them or
19 preventing their discovery;

20

21 **YOU ARE THEREFORE COMMANDED TO SEARCH:**

22 A white 1999 Ford F-150 pickup truck, bearing California
23 license number [REDACTED] and Vehicle Identification Number
24 [REDACTED] which is presently in the custody of the
25 Ventura County Sheriff's Department at a secure storage
26 facility, including all contents and containers within the
27 vehicle

28

1 **FOR THE FOLLOWING PROPERTY:**

2 1. Dangerous or deadly weapons, such as firearms, knives,
3 clubs, or any instrument capable of stabbing, cutting,
4 slicing, or bludgeoning; ammunition, gun pieces, gun
5 cleaning items or kits, firearm operating manuals, expended
6 bullets, empty shell casings, holsters, zippered gun
7 pouches, boxes designated for firearms, and ammunition
8 containers;

9
10 2. Crime scene measurements, photographs, clothing, or other
11 objects bearing blood or bloodstains, human hairs, human
12 tissue or parts thereof, fibers;

13
14 3. Finger, palm, foot, and shoe prints, latent or otherwise;

15
16 4. Any controlled substances and paraphernalia for the
17 use/ingestion of controlled substances.

18
19 5. Papers, documents, and property which tend to show
20 possession, dominion and control over the premises,
21 including, but not limited to, keys, canceled U.S. mail
22 envelopes, rental agreements and receipts, utility and
23 telephone bills, photographs and film, prescription
24 bottles, vehicle registration, address and telephone books,
25 or other documents or clothing of any kind which bear the
26 person's name, phone number or address on it;

27
28

1 **IT IS FURTHER ORDERED**

2 The peace officers executing this search warrant are hereby
3 authorized, pursuant to Penal Code section 1530, to utilize
4 whatever professional or expert assistance or consultants that
5 they consider necessary in order to properly preserve the
6 vehicle and physical evidence; conduct tests, experiments or
7 reenactments, photographically document the vehicle by use of
8 still or video cameras, take various measurements, collect and
9 examine physical evidence.

10

11 **AND TO SEIZE IT IF FOUND** and bring it forthwith before me, or this
12 court, at the courthouse of this court.

13

14

15 This Search Warrant and incorporated Affidavit was sworn to and
16 subscribed before me on this 16 day of NOVEMBER, 2006 at
17 3 pm. Wherefore, I find probable cause for the issuance of
18 this Search Warrant and do issue it.

19

20

21 , NIGHT SEARCH APPROVED: YES NO

22 Judge of the Superior Court, Ventura Judicial District

23

24

25

26

27

28

1 (Affiant's Information)

2 AFFIDAVIT IN SUPPORT OF SEARCH WARRANT

3
4
5
6
7
8
9
10
11
12
13
14
15
16
17
18
19
20
21
22
23
24
25
26
27
28

The facts establishing the foregoing grounds for issuance of a search warrant are as follows. I am your affiant, and I am currently employed as a Sergeant by the Ventura County Sheriff's Department. I have been a full-time Peace Officer in the State of California for over twelve (12) years and was a Peace Officer in the State of Nevada for four (4) years. I also served as a Reserve Peace Officer in the State of California for three (3) years. I am currently assigned to the Ventura County Sheriff's Major Crimes Investigations Bureau as a Detective Sergeant, and I have been so assigned for four (4) years.

I graduated from the Ventura County Criminal Justice Training Center and have attained basic, intermediate, and advanced P.O.S.T. certifications. In addition to receiving over eight hundred (800) hours of training in the basic police academy, I have received over five hundred (500) hours of formal training in criminal investigations and law enforcement tactics from the Drug Enforcement Administration (D.E.A.); the California Department of Justice; the Federal Bureau of Investigation (F.B.I.); the Las Vegas, Nevada, Metropolitan Police Department; the Henderson, Nevada, Police Department; the Nevada Division of Investigation (N.D.I.); the National Law Enforcement Institute; the Kern County Sheriff's Department; the Santa Barbara County Sheriff's Department; the San Jose State University; and the Ventura County Sheriff's Department.

1 I have investigated and been involved in the investigation of no
2 less than four hundred (400) crimes of violence, and I have
3 interviewed more than five hundred (500) victims and
4 perpetrators of violent crimes. I am familiar with the many
5 ways in which violent crimes occur, and I have spoken with and
6 exchanged information with many experienced peace officers from
7 a wide variety of law enforcement agencies who have investigated
8 incidents of violent crime, including criminal homicide.

9
10
11
12
13
14
15
16
17
18
19
20
21
22
23
24
25
26
27
28

1 (Statement of Probable Cause)

2 On October 13, 2006, at about 1845 hours, I responded to a
3 report of an officer-involved shooting in the parking lot of the
4 apartments located at [REDACTED], Thousand Oaks.

5
6 I arrived at [REDACTED] at approximately 1920 hours
7 and found numerous law enforcement resources already deployed at
8 the scene. I entered the apartment complex and found yellow
9 crime scene tape cordoning off the southeast parking lot.

10
11 At the scene, I spoke with Detective Sergeant Mike Powers, who
12 is known to me as a fellow peace officer. Sergeant Powers
13 arrived prior to me, and he had already surveyed the incident
14 scene and spoken with several deputies, including Detective
15 Shane Matthews.

16
17 Sergeant Powers told me, in summary, he learned that Detective
18 Shane Matthews had been standing outside of a nearby apartment,
19 conducting an investigative interview with a witness, when an
20 unidentified Hispanic male, who was unrelated to his
21 investigation, approached him and made a comment similar to,
22 "Are you the cops? You're never going to take me alive."
23 Detective Matthews ignored the unidentified male and continued
24 interviewing the witness.

25
26 After completing his interview, Detective Matthews began to
27 leave when the Hispanic male, who was still in the area, made
28 another comment similar to, "You're never going to take me

1 alive." Detective Matthews attempted to contact the
2 unidentified male when a confrontation unfolded, which resulted
3 in the Hispanic male driving a white Ford pickup truck toward
4 Detective Matthews. Detective Matthews told Sergeant Powers he
5 fired four shots from his service pistol at the Hispanic male
6 and the truck he was driving, which resulted in the Hispanic
7 male sustaining a single gunshot wound to the chest. The truck
8 rolled to a stop in the parking lot and did not strike any
9 vehicles or objects.

10

11 According to Sergeant Powers, Detective Matthews called for
12 assistance and began rendering first aid to the injured male.
13 Ventura County Fire Department personnel and paramedics
14 responded to the scene and continued life saving efforts.
15 During the paramedics' assessment of the male's injuries, a
16 black semi-automatic handgun was found inside the waistband area
17 of the male's pants.

18

19 I examined the incident scene, which had been preserved by
20 sheriff's patrol personnel who responded to the initial
21 incident. I noted five expended silver-colored .40 caliber
22 Speer pistol casings laying on the parking lot within
23 approximately three feet of each other near the entrance/exit to
24 the parking area. I saw several vehicles parked in stalls
25 within the parking area, and I saw a white Ford F-150 pickup
26 truck, California license [REDACTED] resting against the north
27 curb of the parking area. It appeared as though the truck had
28 been traveling from south to north through the parking lot

1 before it came to rest.

2

3 I looked at the Ford pickup truck closer and saw seven impact
4 locations where bullets appeared to have struck the vehicle.
5 There were two bullet holes in the tailgate of the truck; three
6 bullet holes in the windshield, just in front of the driver's
7 seat; one bullet hole in the radiator; and one bullet impact
8 area on the front bumper.

9

10 I looked inside the truck through the windows, and I saw a
11 suitcase and folded clothes on the seat behind the front seats.
12 I saw a small knife wedged between the driver's seat cushion and
13 the backrest, and I saw a pair of binoculars sitting on the seat
14 cushion of the front passenger's seat. I saw a droplet of blood
15 on the inside of the driver's side window, and I saw smears of
16 blood on the steering wheel and driver's seat.

17

18 Looking at the pavement near the driver's side of the truck, I
19 saw two red nylon sheriff's Emergency Medical Kits, and a
20 variety of expended first aid materials. I also saw a cellular
21 telephone, a butane lighter, two black cloth gloves, and a pile
22 of various clothing, some of which was bloody. Additionally, I
23 saw a black colored semi-automatic pistol lying on top of a
24 black pair of pants. I later checked the pistol and confirmed
25 it was loaded with seven .45 caliber cartridges in the magazine
26 with one .45 caliber cartridge in the chamber.

27

28 I directed the collection of the various items of evidence at

1 the scene, and I ordered the towing of the Ford pickup to the
2 sheriff's crime laboratory for further inspection and forensic
3 examination.

4
5 I checked the truck's license number with the Department of
6 Motor Vehicles and learned it was a 1999 model with a Vehicle
7 Identification Number (VIN) of [REDACTED] I compared
8 the VIN with the truck's and found that it matched. The
9 registered owner of the vehicle was listed as Adrian D Canley,

10 [REDACTED]

11

12 I spoke with Detective Scott Peterson, who is known to me as a
13 fellow peace officer. Detective Peterson told me he went to the
14 Los Robles Medical Center and was able to confirm the identity
15 of unidentified Hispanic male who Detective Matthews shot as
16 Adrian Doyle Canley, date of birth [REDACTED] Detective
17 Peterson also confirmed that Canley did not survive his wounds,
18 and had been pronounced dead by a hospital physician.

19

20 I conducted a criminal history check on Adrian Canley and
21 learned he was a convicted felon, having received a felony
22 conviction by the Los Angeles Superior Court in 2002 for
23 violating Penal Code Section 12031(a), Carrying a Loaded Firearm
24 in Public.

25

26 I believe a search of Adrian Canley's vehicle, the white Ford F-
27 150 pickup truck, California license [REDACTED] will reveal
28 additional evidence of Canley's criminal behavior, which may

1 help to explain why this incident occurred. I also believe a
2 search of the vehicle, including the employment of scientific
3 instruments by forensic examiners, will enable investigators to
4 reconstruct the incident more precisely and accurately.

5

6 Based on the aforementioned information, which is set forth to
7 the best belief and ability of your affiant, your affiant
8 respectfully requests that a search warrant be issued for
9 Canley's vehicle, including all contents and containers.

10

11 I also request the court issue an order sealing the contents of
12 the affidavit. Disclosing the contents of the affiant's
13 information to the public and press could result in potential
14 witnesses being tipped off concerning our investigation. Such
15 information could result in the destruction of important
16 evidence, such as crucial witness statements. It is therefore
17 necessary for law enforcement to withhold the information
18 contained within the affiant's information from the public.

19

20

21

22

23

24

25

26

27

28

**STATE OF CALIFORNIA
COUNTY OF VENTURA**

1. SEARCH WARRANT NO.

2. CASE NO. **06-30492**

LOCATION SEARCHED: **WHITE 1999 FORD F-150** [REDACTED]

PAGE **1** OF **1**

3. INVENTORY OF PROPERTY TAKEN ON SEARCH WARRANT (PENAL CODE 1537) 4. DATE/TIME **10/16/06 1545** 5. RD **3999** 6. BEAT **05**

7. ITEM NO. 1	8. PERSON PROPERTY BOOKED TO (Last Name, First, Middle, Gen.)	9. STORAGE LOCATION	10. EVIDENCE / WORK REQUESTED
-------------------------	---	---------------------	-------------------------------

11. LOCATION WHERE PROPERTY FOUND OR TAKEN INTO CUSTODY
CD CASE BEHIND FRONT PASSENGER SEAT

12. PROPERTY: Itemized, Detailed Description of Same, Including Color, Size, Serial Number, Etc...
3 COMPACT DISCS

13. OFFICER LOCATING PROPERTY // I.D. NO. R. DAVIDSON 2775	14. PHOTO <input checked="" type="checkbox"/> YES <input type="checkbox"/> NO	15. SEIZED / 11470 H & S <input checked="" type="checkbox"/> YES <input type="checkbox"/> NO	16. OFFICER SEIZING PROPERTY // I.D. NO. R. DAVIDSON 2775	17. OFFICER BOOKING PROPERTY R. DAVIDSON 2775
--	--	---	---	---

18. ITEM NO. 2	19. PERSON PROPERTY BOOKED TO (Last Name, First, Middle, Gen.)	20. STORAGE LOCATION	21. EVIDENCE / WORK REQUESTED
--------------------------	--	----------------------	-------------------------------

22. LOCATION WHERE PROPERTY FOUND OR TAKEN INTO CUSTODY

23. PROPERTY: Itemized, Detailed Description of Same, Including Color, Size, Serial Number, Etc...
MISC. ITEMS OF DOMESTIC & CONTROL - ELECTRIC BILL, RETIREMENT STATEMENT

SUPERIOR COURT MINUTE ORDER

24. OFFICER LOCATING PROPERTY // I.D. NO. R. DAVIDSON 2775	25. PHOTO <input checked="" type="checkbox"/> YES <input type="checkbox"/> NO	26. SEIZED / 11470 H & S <input checked="" type="checkbox"/> YES <input type="checkbox"/> NO	27. OFFICER SEIZING PROPERTY // I.D. NO. R. DAVIDSON 2775	28. OFFICER BOOKING PROPERTY R. DAVIDSON 2775
--	--	---	---	---

29. ITEM NO. 3	30. PERSON PROPERTY BOOKED TO (Last Name, First, Middle, Gen.)	31. STORAGE LOCATION	32. EVIDENCE / WORK REQUESTED
--------------------------	--	----------------------	-------------------------------

33. LOCATION WHERE PROPERTY FOUND OR TAKEN INTO CUSTODY
INSIDE REAR TAILGATE

34. PROPERTY: Itemized, Detailed Description of Same, Including Color, Size, Serial Number, Etc...
EXPANDED BULLET & TICKET

35. OFFICER LOCATING PROPERTY // I.D. NO. R. DAVIDSON 2775	36. PHOTO <input checked="" type="checkbox"/> YES <input type="checkbox"/> NO	37. SEIZED / 11470 H & S <input checked="" type="checkbox"/> YES <input type="checkbox"/> NO	38. OFFICER SEIZING PROPERTY // I.D. NO. R. DAVIDSON 2775	39. OFFICER BOOKING PROPERTY
--	--	---	---	------------------------------

40. ITEM NO. 4	41. PERSON PROPERTY BOOKED TO (Last Name, First, Middle, Gen.)	42. STORAGE LOCATION	43. EVIDENCE / WORK REQUESTED
--------------------------	--	----------------------	-------------------------------

44. LOCATION WHERE PROPERTY FOUND OR TAKEN INTO CUSTODY
BEHIND BACK SEAT OF REAR SEAT

45. PROPERTY: Itemized, Detailed Description of Same, Including Color, Size, Serial Number, Etc...
EXPANDED BULLET

46. OFFICER LOCATING PROPERTY // I.D. NO. R. DAVIDSON 2775	47. PHOTO <input type="checkbox"/> YES <input type="checkbox"/> NO	48. SEIZED / 11470 H & S <input checked="" type="checkbox"/> YES <input type="checkbox"/> NO	49. OFFICER SEIZING PROPERTY // I.D. NO. R. DAVIDSON 2775	50. OFFICER BOOKING PROPERTY
--	---	---	---	------------------------------

51. ITEM NO. 5	52. PERSON PROPERTY BOOKED TO (Last Name, First, Middle, Gen.)	53. STORAGE LOCATION	54. EVIDENCE / WORK REQUESTED
--------------------------	--	----------------------	-------------------------------

55. LOCATION WHERE PROPERTY FOUND OR TAKEN INTO CUSTODY
FRONT BUNKER

56. PROPERTY: Itemized, Detailed Description of Same, Including Color, Size, Serial Number, Etc...
EXPANDED BULLET

57. OFFICER LOCATING PROPERTY // I.D. NO. R. DAVIDSON 2775	58. PHOTO <input checked="" type="checkbox"/> YES <input type="checkbox"/> NO	59. SEIZED / 11470 H & S <input checked="" type="checkbox"/> YES <input type="checkbox"/> NO	60. OFFICER SEIZING PROPERTY // I.D. NO. R. DAVIDSON 2775	61. OFFICER BOOKING PROPERTY
--	--	---	---	------------------------------

The above is a detailed list of all property taken by me under authority of a search warrant issued the **16** day of **Nov.**, **2006**, in the Ventura County **SUPERIOR** Court.

W. A. HUB / 3318 K... Officer's Signature: W. J. Ay

1
2
3
4
5
6
7
8
9
10
11
12
13
14
15
16
17
18
19
20
21
22
23
24
25
26
27
28

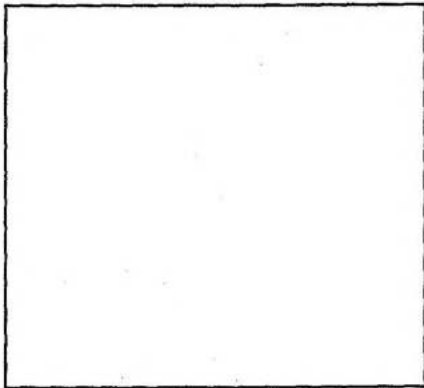

STATE OF CALIFORNIA – COUNTY OF VENTURA
AFFIDAVIT IN SUPPORT OF SEALING
AFFIANT INFORMATION

I, Detective Sergeant William Ayub, am a sworn member of the
Ventura County Sheriff's Department.

Pursuant to this case, I am the affiant to a search warrant
issued by the Honorable Edward F. Brodie
on Nov 16, 2006.

Disclosing the contents of the affiant's information to the
public and press could result in potential witnesses being
tipped off concerning our investigation. Such information could
result in the destruction of important evidence, such as crucial
witness statements. It is therefore necessary for law
enforcement to withhold the information contained within the
affiant's information from the public.

I declare under penalty of perjury, under the laws of the State
of California, the foregoing is true and correct and that this
affidavit is executed on November 16, 2006, in the County of
Ventura, State of California.

William F. Ayub

Signature of Affiant

SEARCH WARRANT
PROPERTY RECORD

VENTURA COUNTY SHERIFF'S DEPARTMENT
NCIC / CII CA0560000

1. SEARCH WARRANT NO.

LOCATION SEARCHED: WHITE 1999 FORD F-150 [REDACTED]

PAGE 1 OF 1

2. CASE NO. 06-30492

3. EVIDENCE SEIZED PURSUANT TO SEARCH WARRANT
4. DATE / TIME 11/16/06 1545 5. RD 3999 6. BEAT 15

7. ITEM NO. 1 8. PERSON PROPERTY BOOKED TO (Last Name, First, Middle, Gen.) 9. STORAGE LOCATION HEADQUARTERS 10. EVIDENCE / WORK REQUESTED

11. LOCATION WHERE PROPERTY FOUND OR TAKEN INTO CUSTODY
CD CASE BEHIND FRONT PASSENGER SEAT

12. PROPERTY: Itemized, Detailed Description of Same, Including Color, Size, Serial Number, Etc...
3 COMPACT DISCS

13. OFFICER LOCATING PROPERTY / ID. NO. R. DAVIDSON 2775 14. PHOTO [X] YES [] NO 15. SEIZED / 11470 H & S [X] YES [] NO 16. OFFICER SEIZING PROPERTY / ID. NO. R. DAVIDSON 2775 17. OFFICER BOOKING PROPERTY R. DAVIDSON 2775

18. ITEM NO. 2 19. PERSON PROPERTY BOOKED TO (Last Name, First, Middle, Gen.) 20. STORAGE LOCATION HEADQUARTERS 21. EVIDENCE / WORK REQUESTED

22. LOCATION WHERE PROPERTY FOUND OR TAKEN INTO CUSTODY

23. PROPERTY: Itemized, Detailed Description of Same, Including Color, Size, Serial Number, Etc...
MISC. ITEMS OF DOMINION & CONTROL - ELECTRIC BILL, RETIREMENT STATEMENT,

SUPERIOR COURT MINUTE ORDER

24. OFFICER LOCATING PROPERTY / ID. NO. R. DAVIDSON 2775 25. PHOTO [X] YES [] NO 26. SEIZED / 11470 H & S [X] YES [] NO 27. OFFICER SEIZING PROPERTY / ID. NO. R. DAVIDSON 2775 28. OFFICER BOOKING PROPERTY R. DAVIDSON 2775

29. ITEM NO. 3 30. PERSON PROPERTY BOOKED TO (Last Name, First, Middle, Gen.) 31. STORAGE LOCATION HEADQUARTERS 32. EVIDENCE / WORK REQUESTED

33. LOCATION WHERE PROPERTY FOUND OR TAKEN INTO CUSTODY
INSIDE REAR TAILGATE

34. PROPERTY: Itemized, Detailed Description of Same, Including Color, Size, Serial Number, Etc...
EXPENDED BULLET & JACKET

35. OFFICER LOCATING PROPERTY / ID. NO. R. DAVIDSON 2775 36. PHOTO [X] YES [] NO 37. SEIZED / 11470 H & S [X] YES [] NO 38. OFFICER SEIZING PROPERTY / ID. NO. R. DAVIDSON 2775 39. OFFICER BOOKING PROPERTY

40. ITEM NO. 4 41. PERSON PROPERTY BOOKED TO (Last Name, First, Middle, Gen.) 42. STORAGE LOCATION HEADQUARTERS 43. EVIDENCE / WORK REQUESTED

44. LOCATION WHERE PROPERTY FOUND OR TAKEN INTO CUSTODY
BEHIND BACKREST OF REAR SEAT

45. PROPERTY: Itemized, Detailed Description of Same, Including Color, Size, Serial Number, Etc...
EXPENDED BULLET

46. OFFICER LOCATING PROPERTY / ID. NO. R. DAVIDSON 2775 47. PHOTO [X] YES [] NO 48. SEIZED / 11470 H & S [X] YES [] NO 49. OFFICER SEIZING PROPERTY / ID. NO. R. DAVIDSON 2775 50. OFFICER BOOKING PROPERTY

51. ITEM NO. 5 52. PERSON PROPERTY BOOKED TO (Last Name, First, Middle, Gen.) 53. STORAGE LOCATION HEADQUARTERS 54. EVIDENCE / WORK REQUESTED

55. LOCATION WHERE PROPERTY FOUND OR TAKEN INTO CUSTODY
FRONT BUMPER

56. PROPERTY: Itemized, Detailed Description of Same, Including Color, Size, Serial Number, Etc...
EXPENDED BULLET

57. OFFICER LOCATING PROPERTY / ID. NO. R. DAVIDSON 2775 58. PHOTO [X] YES [] NO 59. SEIZED / 11470 H & S [X] YES [] NO 60. OFFICER SEIZING PROPERTY / ID. NO. R. DAVIDSON 2775 61. OFFICER BOOKING PROPERTY

62. LIST ALL DEFENDANTS AND CHARGES (Last Name, First, D.O.B., Code Section(s))
ITEMS 3, 4, 5 RELEASED TO FORENSIC FIREARMS EXAMINER JIM ROBERTS

63. REPORTING OFFICER - ID. NO. / DIV. / UNIT
W. AYUB / 3318 / SPEC. SVC. / MC

64. APPROVED BY / ID. NO.



185690-003336-0
ADRIAN DOYLE CANLEY

Gray, Inc. Retirement Savings Plan and
Trust

Account Summary

07/01/2006 - 09/30/2006

Balance on All Accounts (07/01/2006)	\$	87.23
Earnings Gain/Loss	\$	3.89
Contributions	\$	0.00
Expenses	\$	0.00
Distributions	\$	0.00
Other (See pages 4 & 5 for details)	\$	0.00
Balance on All Accounts (09/30/2006)	\$	91.12

Your Vested Balance \$ 54.65

Your Account Rate of Return for the period 4.51%

Message Board

If you have any questions concerning the information contained in this statement, please contact your employer or a representative in our **Customer Service Center** by dialing (toll free) **1-866-680-7000** between 9 a.m. and 5 p.m. EST Monday - Friday. Also let us know of any address changes.

View your account balance each day at our website at www.unifiedtrust.com or by calling the voice response unit at 1-800-845-5151. Please note that any PIN changes you make on the website will not change your PIN on the voice response unit.

Every effort has been made to ensure the highest degree of accuracy for your account. Please review this statement carefully and notify your plan administrator within 10 days of receipt if you believe there is an error. Thereafter, we will correct the error but cannot accept responsibility for any market fluctuation or related expense.

Under the direction of the Securities Exchange Commission, Mutual Fund Companies are requiring Financial Intermediaries, such as Unified Trust Company, to begin assessing redemption fees for the short-term sale of shares in certain funds. Some of the funds that are offered in your retirement plan may be affected. To review the status of the funds in your account, find any applicable trading fee, and define the period of time that is used by the fund for the calculation of any applicable redemption fee, please refer to the prospectus that is available on line. You can view each prospectus by accessing your account at www.unifiedtrust.com.

Investment Performance

For the period ending 09/30/2006 Investment Options	Total Return		Annualized Total Return			Inception Date	Investment Type
	Qtr.	1 Yr.	3 Yrs.	5 Yrs.	10 Yrs.		
American Funds American Balanced Fund (A)	4.49%	8.85%	9.38%	8.13%	9.75%	01/02/1933	Equities
Am. Century Inflation Adj. Bond Fund (Adv) ⁰³	3.45%	1.34%	4.14%	6.29%	5.91%*	02/10/1997	Fixed Income
Columbia Acorn Fund (Z)	0.47%	9.59%	18.69%	17.13%	14.79%	06/10/1970	Equities
American Funds EuroPacific Growth Fund (A)	4.99%	20.05%	22.88%	15.36%	11.01%	04/16/1984	Equities
American Funds Growth Fund of America (A)	1.45%	9.48%	14.35%	10.15%	13.08%	11/30/1973	Equities
American Funds Income Fund of America (A)	5.62%	13.27%	13.51%	10.49%	10.15%	12/31/1970	Equities
Dodge & Cox Stock Fund	4.82%	14.61%	18.20%	14.06%	14.48%	01/04/1965	Equities
Managers Fremont Bond Fund	3.74%	3.27%	3.88%	5.22%	7.02%	04/30/1993	Fixed Income
Federated Mid-Cap Index Fund	-1.21%	6.09%	14.66%	12.45%	12.63%	11/05/1992	Equities
First American Real Estate Secs. Fund (A)	9.67%	32.19%	28.69%	24.19%	16.45%	09/29/1995	Equities
Janus Growth and Income Fund	1.60%	4.90%	13.33%	6.82%	10.80%	05/15/1991	Equities
UTC Stable Value Trust	1.20%	4.67%	4.56%	4.74%	5.45%*	NA	Stable Value/Money Market
Royce Opportunity Fund (Inv)	-0.07%	11.96%	17.41%	18.62%	17.27%*	11/20/1996	Equities
T. Rowe Price Mid Cap Value Fund (Adv)	5.20%	14.63%	18.64%	NA	21.12%*	09/30/2002	Equities
American Century Income & Growth Fund (Adv) ⁰³	4.83%	7.77%	12.80%	7.75%	8.96%	12/17/1990	Equities
T. Rowe Price Equity Income Fund (Adv)	5.47%	12.46%	14.29%	9.22%	8.59%*	03/31/2000	Equities
Phoenix Insight Small Cap Value Fund (A)	0.60%	4.41%	19.25%	14.78%	NA	08/18/1999	Equities
Keeley Small Cap Value Fund	-6.35%	8.25%	25.05%	19.32%	16.08%	10/01/1993	Equities

Mutual funds are not bank deposits or obligations, are not guaranteed by any bank, and are not insured or guaranteed by the FDIC, The Federal Reserve Board, or any other government agency. Investment in mutual funds involves risk, including possible loss of principal.

Performance quoted is past performance and is not indicative of future results. Investment return and principal value will fluctuate so that an investor's shares, when redeemed, may be worth more or less than their original cost. Performance figures represent an investment made at the beginning of the reporting period. Results for investments made during the report period will differ. Performance information is taken from sources believed to be reliable, but is not guaranteed as to completeness or accuracy.

⁰³ For periods prior to the first full quarter after inception, Investor Class performance has been restated to reflect the expenses of the Advisor Class.

* If no ten-year record is available, return is since inception.

Allocation Analyzer

The information below indicates how your Employer is being invested (New Contribution Allocation) and the current value of your account (Existing Balance Allocation). Review your New Contribution Allocation to ensure these funds and investment categories still match your objectives. Also compare the Existing Balance Allocation to the New Contribution Allocation periodically to determine if your Existing Balance Allocation continues to reflect your objectives. Refer also to the full list of investment options offered by the plan sponsor.

New Contribution Allocation

Not Available

Existing Balance Allocation



- Equities (100.00%)
100.00% American Funds American Balanced Fund (
- Fixed Income (0.00%)
- Stable Value/Money Market (0.00%)

Source Summary			
<i>Source</i>	<i>Total Balance</i>	<i>Vested %</i>	<i>Vested Amount</i>
Employer	\$ 47.80	60%	\$ 28.67
Match	\$ 43.32	60%	\$ 25.98
TOTAL	\$ 91.12		\$ 54.65

Summary Statement Of Activity

Period Covered

ADRIAN DOYLE CANLEY	American Funds American Balanced Fund (A)	Total
Units - Start of Period	4.846	
Start of Period Unit Value	\$18.00	
Units - End of Period	4.878	
End of Period Unit Value	\$18.68	
Beginning balance	\$ 87.23	\$ 87.23
Contribution	0.00	0.00
Distribution	0.00	0.00
Dividend	0.62	0.62
Forfeiture	0.00	0.00
Gain/Loss	3.27	3.27
Loan distribution	0.00	0.00
Loan repayment	0.00	0.00
Transfer	0.00	0.00
Ending balance	\$ 91.12	\$ 91.12

THIS SPACE INTENTIONALLY LEFT BLANK



Southern California Edison Company
P.O. Box 600, Rosemead, CA 91771-0001

Visit us at:
www.sce.com

Customer and Service Address
CANLEY, ADRIAN

Date Bill Prepared
Aug 22, 2006
Next Meter Read on or about
Sept 20, 2006

Your Customer Account Number

24-hr. Customer Service

1 (800) 684-8123

Service Account Rotating Outage Rate Schedule
Group A075 DOMESTIC

Billing summary

Amount of Previous Statement 07/22/06	\$	158.44
Previous Charges Due Immediately	\$	158.44
Current Charges	\$	45.69
Late Pymt Chrg	\$	1.20
Current Amount Due 09/11/06	\$	46.89
Your Total Balance Due	\$	205.33

Your current energy usage

Meter Number	From	To	Usage
ACTUAL READ 208-455535	07/21/06 56888	08/21/06 57265	377 kWh
Usage Comparison	This Year	Last Year	2 Years Ago
Kilowatt-hour (kWh) used	377.00	No	No
Number of days	31	Comparable	Comparable
Average usage per day	12.16	Usage	Usage

Did you know. . .

*** * Disconnection of Service Notice * ***

The PRIOR PAST DUE amount shown on the payment stub must be paid today to avoid disconnection. (Your service may already be disconnected by the time you receive this bill.) The PAST DUE amount must be paid by 5PM on the date shown on the payment stub to avoid disconnection.

Late Payment Charge Reminder...

A late payment charge of 0.9% will be applied to the total unpaid balance on your account if full payment is not received by the due date on this bill.

SAVE TIME WITH ONLINE BILLING..

Managing your SCE bills is easy as Online Billing. Sign up now and after 3 months of using Online Billing we'll send you a Starbucks Card loaded with \$5. Take advantage of our online payment options and you'll save on postage. Conditions apply.

Go to www.sce.com/ebill for complete details.



Southern California Edison Company
P.O. Box 600, Rosemead, CA 91771-0001

Visit us at:
www.sce.com

Customer and Service Address
CANLEY, ADRIAN

Date Bill Prepared
Aug 22, 2006
Next Meter Read on or about
Sept 20, 2006

Your Customer Account Number

1 (800) 684-8123

Service Account Rotating Outage Rate Schedule
Group A075 DOMESTIC

Detail of current charges: \$45.69

We provide two ways to look at your current charges:

1 By usage:

Billing Period - 07/21/06 to 08/21/06 (31 days) - Summer Season

Delivery Related Charges (A)		\$	22.96
Generation Related Charges (B)			22.65

Current Billing Detail Subtotal		\$	45.61
State Tax	377 kWh x \$ 0.00022		0.08

Current Charges Due 09/11/06		\$	45.69
-------------------------------------	--	----	--------------

(A) Delivery Related Charges:			
Basic Charge	31 Days	x \$ 0.02200	\$ 0.68
Energy Charge:			
Baseline-Summer	112 kWh	x \$ 0.03903	4.37
Over Baseline 1%-30%	22 kWh	x \$ 0.04089	0.90
Baseline-Summer	204 kWh	x \$ 0.06244	12.74
Over Baseline 1%-30%	39 kWh	x \$ 0.06244	2.44
DWR Bond Charge	377 kWh	x \$ 0.00485	1.83

Delivery Subtotal	377 kWh		\$ 22.96
-------------------	---------	--	----------

(B) Generation Related Charges:			
DWR Generation:			
Baseline-Summer	27 kWh	x \$ 0.10369	\$ 2.80
Over Baseline 1%-30%	5 kWh	x \$ 0.10369	0.52
Baseline-Summer	49 kWh	x \$ 0.10369	5.08
Over Baseline 1%-30%	9 kWh	x \$ 0.10369	0.93
SCE Generation:			
Baseline-Summer	85 kWh	x \$ 0.06302	5.36
Over Baseline 1%-30%	17 kWh	x \$ 0.08711	1.48
Baseline-Summer	155 kWh	x \$ 0.03073	4.76
Over Baseline 1%-30%	30 kWh	x \$ 0.05739	1.72

Generation Subtotal	377 kWh		\$ 22.65
---------------------	---------	--	----------

Your daily average cost this period is : \$ 1.47

MINUTE ORDER

Case Number 2006037553 M A

People Vs Canley, Adrian Doyle

0 Days from first appearance

Name: Canley, Adrian Doyle

Court Room: 11

For: 11/06/06 09:00 AM

Case #: 2006037553 M A

Atty Name:

Case Status: Open

Release Status: Released on Own Recognizance (O.R.)

Charging Document:

Bail Set Amt:

Defendant InformationBooking Information

Address

[REDACTED]

[REDACTED]

[REDACTED]

[REDACTED]

Alias Type

Name

Court true name

Canley, Adrian D

<u>Docket Dt</u>	<u>Seq</u>	<u>Code</u>	<u>Text</u>
11/06/2006	1	HHELD	<u>Missing Complaint Continued</u> Heard in Courtroom 11 on Nov 06, 2006 at 09:00 AM.
	2	OFJUD	Judge Pumell, Roland N.
	3	OFJA	Judicial Assistant - Thoroughgood, Amy.
	4	FCFTR	Digital recorder - 10:41 AM.
	5	PP	The defendant is present in court.
	6	FPDA	Deputy District Attorney Patel present.
	7	RQCONT	People request for continuance is granted.
	8	CLCONT	Case continued to 12/11/06 at 09:00 AM in Courtroom 11 for Missing Complaint Continued.
	9	BLCRC	Your release on your own recognizance continues.

I have received a copy of these conditions. I understand and agree to each of the conditions listed above.

Date

Defendant's Signature

Defendant's Telephone #

Defendant's Address

Explained/Translated By

Defendant's City, State and Zip Code



185690-003336-0
ADRIAN DOYLE CANLEY



Gray, Inc. Retirement Savings Plan and
Trust

Account Summary

07/01/2006 - 09/30/2006

Balance on All Accounts (07/01/2006)	\$	87.23
Earnings Gain/Loss	\$	3.89
Contributions	\$	0.00
Expenses	\$	0.00
Distributions	\$	0.00
Other (See pages 4 & 5 for details)	\$	0.00
Balance on All Accounts (09/30/2006)	\$	91.12

Your Vested Balance \$ 54.65

Your Account Rate of Return for the period 4.51%

Message Board



If you have any questions concerning the information contained in this statement, please contact your employer or a representative in our **Customer Service Center** by dialing (toll free) **1-866-680-7000** between 9 a.m. and 5 p.m. EST Monday - Friday. Also let us know of any address changes.

View your account balance each day at our website at www.unifiedtrust.com or by calling the voice response unit at 1-800-845-5151. Please note that any PIN changes you make on the website will not change your PIN on the voice response unit.

Every effort has been made to ensure the highest degree of accuracy for your account. Please review this statement carefully and notify your plan administrator within 10 days of receipt if you believe there is an error. Thereafter, we will correct the error but cannot accept responsibility for any market fluctuation or related expense.

Under the direction of the Securities Exchange Commission, Mutual Fund Companies are requiring Financial Intermediaries, such as Unified Trust Company, to begin assessing redemption fees for the short-term sale of shares in certain funds. Some of the funds that are offered in your retirement plan may be affected. To review the status of the funds in your account, find any applicable trading fee, and define the period of time that is used by the fund for the calculation of any applicable redemption fee, please refer to the prospectus that is available on line. You can view each prospectus by accessing your account at www.unifiedtrust.com.

Investment Performance

For the period ending 09/30/2006 Investment Options	Total Return		Annualized Total Return			Inception Date	Investment Type
	Qtr.	1 Yr.	3 Yrs.	5 Yrs.	10 Yrs.		
American Funds American Balanced Fund (A)	4.49%	8.85%	9.38%	8.13%	9.75%	01/02/1933	Equities
Am. Century Inflation Adj. Bond Fund (Adv) ⁰³	3.45%	1.34%	4.14%	6.29%	5.91%	02/10/1997	Fixed Income
Columbia Acorn Fund (Z)	0.47%	9.59%	18.69%	17.13%	14.79%	06/10/1970	Equities
American Funds EuroPacific Growth Fund (A)	4.99%	20.05%	22.88%	15.36%	11.01%	04/16/1984	Equities
American Funds Growth Fund of America (A)	1.45%	9.48%	14.35%	10.15%	13.08%	11/30/1973	Equities
American Funds Income Fund of America (A)	5.62%	13.27%	13.51%	10.49%	10.15%	12/31/1970	Equities
Dodge & Cox Stock Fund	4.82%	14.61%	18.20%	14.06%	14.48%	01/04/1965	Equities
Managers Fremont Bond Fund	3.74%	3.27%	3.88%	5.22%	7.02%	04/30/1993	Fixed Income
Federated Mid-Cap Index Fund	-1.21%	6.09%	14.66%	12.45%	12.63%	11/05/1992	Equities
First American Real Estate Secs. Fund (A)	9.67%	32.19%	28.69%	24.19%	16.45%	09/29/1995	Equities
Janus Growth and Income Fund	1.60%	4.90%	13.33%	6.82%	10.80%	05/15/1991	Equities
UTC Stable Value Trust	1.20%	4.67%	4.56%	4.74%	5.45%	NA	Stable Value/Money Market
Royce Opportunity Fund (Inv)	-0.07%	11.96%	17.41%	18.62%	17.27%	11/20/1996	Equities
T. Rowe Price Mid Cap Value Fund (Adv)	5.20%	14.63%	18.64%	NA	21.12%	09/30/2002	Equities
American Century Income & Growth Fund (Adv) ⁰³	4.83%	7.77%	12.80%	7.75%	8.96%	12/17/1990	Equities
T. Rowe Price Equity Income Fund (Adv)	5.47%	12.46%	14.29%	9.22%	8.59%	03/31/2000	Equities
Phoenix Insight Small Cap Value Fund (A)	0.60%	4.41%	19.25%	14.78%	NA	08/18/1999	Equities
Keeley Small Cap Value Fund	-6.35%	8.25%	25.05%	19.32%	16.08%	10/01/1993	Equities

Mutual funds are not bank deposits or obligations, are not guaranteed by any bank, and are not insured or guaranteed by the FDIC, The Federal Reserve Board, or any other government agency. Investment in mutual funds involves risk, including possible loss of principal.

Performance quoted is past performance and is not indicative of future results. Investment return and principal value will fluctuate so that an investor's shares, when redeemed, may be worth more or less than their original cost. Performance figures represent an investment made at the beginning of the reporting period. Results for investments made during the report period will differ. Performance information is taken from sources believed to be reliable, but is not guaranteed as to completeness or accuracy.

⁰³ For periods prior to the first full quarter after inception, Investor Class performance has been restated to reflect the expenses of the Advisor Class.

* If no ten-year record is available, return is since inception.

Allocation Analyzer

The information below indicates how your Employer is being invested (New Contribution Allocation) and the current value of your account (Existing Balance Allocation). Review your New Contribution Allocation to ensure these funds and investment categories still match your objectives. Also compare the Existing Balance Allocation to the New Contribution Allocation periodically to determine if your Existing Balance Allocation continues to reflect your objectives. Refer also to the full list of investment options offered by the plan sponsor.

New Contribution Allocation

Not Available

Existing Balance Allocation



-  **Equities (100.00%)**
100.00% American Funds American Balanced Fund (
-  **Fixed Income (0.00%)**
-  **Stable Value/Money Market (0.00%)**

Source Summary			
<i>Source</i>	<i>Total Balance</i>	<i>Vested %</i>	<i>Vested Amount</i>
Employer	\$ 47.80	60%	\$ 28.67
Match	\$ 43.32	60%	\$ 25.98
TOTAL	\$ 91.12		\$ 54.65

Summary Statement Of Activity

Period Covered

	American Funds American Balanced Fund (A)	Total
ADRIAN DOYLE CANLEY		
Units - Start of Period	4.846	
Start of Period Unit Value	\$18.00	
Units - End of Period	4.878	
End of Period Unit Value	\$18.68	
Beginning balance	\$ 87.23	\$ 87.23
Contribution	0.00	0.00
Distribution	0.00	0.00
Dividend	0.62	0.62
Forfeiture	0.00	0.00
Gain/Loss	3.27	3.27
Loan distribution	0.00	0.00
Loan repayment	0.00	0.00
Transfer	0.00	0.00
Ending balance	\$ 91.12	\$ 91.12

THIS SPACE INTENTIONALLY LEFT BLANK



Southern California Edison Company
P.O. Box 600, Rosemead, CA 91771-0001

Visit us at:
www.sce.com

Customer and Service Address
CANLEY, ADRIAN

Date Bill Prepared
Aug 22, 2006
Next Meter Read on or about
Sept 20, 2006

Your Customer Account Number

24-hr. Customer Service

1 (800) 684-8123

Service Account Rotating Outage Rate Schedule
Group A075 DOMESTIC

Billing summary

Amount of Previous Statement 07/22/06	\$	158.44
Previous Charges Due Immediately	\$	158.44
Current Charges	\$	45.69
Late Pymt Chrg	\$	1.20
Current Amount Due 09/11/06	\$	46.89
Your Total Balance Due	\$	205.33

Your current energy usage

Meter Number	From	To	Usage
ACTUAL READ 208-455535	07/21/06 56888	08/21/06 57265	377 kWh
Usage Comparison	This Year	Last Year	2 Years Ago
Kilowatt-hour (kWh) used	377.00	No	No
Number of days	31	Comparable	Comparable
Average usage per day	12.16	Usage	Usage

Did you know...

*** * Disconnection of Service Notice * ***

The PRIOR PAST DUE amount shown on the payment stub must be paid today to avoid disconnection. (Your service may already be disconnected by the time you receive this bill.) The PAST DUE amount must be paid by 5PM on the date shown on the payment stub to avoid disconnection.

Late Payment Charge Reminder...

A late payment charge of 0.9% will be applied to the total unpaid balance on your account if full payment is not received by the due date on this bill.

SAVE TIME WITH ONLINE BILLING...

Managing your SCE bills is easy as Online Billing. Sign up now and after 3 months of using Online Billing we'll send you a Starbucks Card loaded with \$5. Take advantage of our online payment options and you'll save on postage. Conditions apply.

Go to www.sce.com/ebill for complete details.



Southern California Edison Company
P.O. Box 600, Rosemead, CA 91771-0001

Visit us at:
www.sce.com

Customer and Service Address
CANLEY, ADRIAN

Date Bill Prepared
Aug 22, 2006
Next Meter Read on or about
Sept 20, 2006

Your Customer Account Number

24-hr. Customer Service

1 (800) 684-8123

Service Account Rotating Outage Rate Schedule
Group A075 DOMESTIC

Detail of current charges: \$45.69

We provide two ways to look at your current charges:

1 By usage:

Billing Period - 07/21/06 to 08/21/06 (31 days) - Summer Season

Delivery Related Charges (A)		\$	22.96
Generation Related Charges (B)			22.65

Current Billing Detail Subtotal		\$	45.61
State Tax	377 kWh x \$ 0.00022		0.08

Current Charges Due 09/11/06		\$	45.69
-------------------------------------	--	----	--------------

(A) Delivery Related Charges:			
Basic Charge	31 Days	x \$ 0.02200	\$ 0.68
Energy Charge:			
Baseline-Summer	112 kWh	x \$ 0.03903	4.37
Over Baseline 1%-30%	22 kWh	x \$ 0.04089	0.90
Baseline-Summer	204 kWh	x \$ 0.06244	12.74
Over Baseline 1%-30%	39 kWh	x \$ 0.06244	2.44
DWR Bond Charge	377 kWh	x \$ 0.00485	1.83
Delivery Subtotal	377 kWh		\$ 22.96

(B) Generation Related Charges:			
DWR Generation:			
Baseline-Summer	27 kWh	x \$ 0.10369	\$ 2.80
Over Baseline 1%-30%	5 kWh	x \$ 0.10369	0.52
Baseline-Summer	49 kWh	x \$ 0.10369	5.08
Over Baseline 1%-30%	9 kWh	x \$ 0.10369	0.93
SCE Generation:			
Baseline-Summer	85 kWh	x \$ 0.06302	5.36
Over Baseline 1%-30%	17 kWh	x \$ 0.08711	1.48
Baseline-Summer	155 kWh	x \$ 0.03073	4.76
Over Baseline 1%-30%	30 kWh	x \$ 0.05739	1.72
Generation Subtotal	377 kWh		\$ 22.65

Your daily average cost this period is : \$ 1.47

MINUTE ORDER

Case Number 2006037553 M A

People Vs Canley, Adrian Doyle

0 Days from first appearance

Name: Canley, Adrian Doyle

Court Room: 11

For: 11/06/06 09:00 AM

Case #: 2006037553 M A

Atty Name:

Case Status: Open

Release Status: Released on Own Recognizance (O.R.)

Charging Document:

Bail Set Amt:

Defendant InformationBooking Information

Court true name Canley, Adrian D

<u>Docket Dt</u>	<u>Seq</u>	<u>Code</u>	<u>Text</u>
11/06/2006	1	HHELD	<u>Missing Complaint Continued</u> Heard in Courtroom 11 on Nov 06, 2006 at 09:00 AM.
	2	OFJUD	Judge Purnell, Roland N.
	3	OFJA	Judicial Assistant - Thoroughgood, Amy.
	4	FCFTR	Digital recorder - 10:41 AM.
	5	PP	The defendant is present in court.
	6	PPDA	Deputy District Attorney Patel present.
	7	RQCONT	People request for continuance is granted.
	8	CLCONT	Case continued to 12/11/06 at 09:00 AM in Courtroom 11 for Missing Complaint Continued
	9	BLORC	Your release on your own recognizance continues.

I have received a copy of these conditions. I understand and agree to each of the conditions listed above.

Date

Defendant's Signature

Defendant's Telephone #

Defendant's Address

Explained/Translated By

Defendant's City, State and Zip Code



185690-003336-0
ADRIAN DOYLE CANLEY

Gray, Inc. Retirement Savings Plan and
Trust

Account Summary

07/01/2006 - 09/30/2006

Balance on All Accounts (07/01/2006)	\$	87.23
Earnings Gain/Loss	\$	3.89
Contributions	\$	0.00
Expenses	\$	0.00
Distributions	\$	0.00
Other (See pages 4 & 5 for details)	\$	0.00
Balance on All Accounts (09/30/2006)	\$	91.12

Your Vested Balance \$ 54.65

Your Account Rate of Return for the period 4.51%

Message Board



If you have any questions concerning the information contained in this statement, please contact your employer or a representative in our **Customer Service Center** by dialing (toll free) **1-866-680-7000** between 9 a.m. and 5 p.m. EST Monday - Friday. Also let us know of any address changes.

View your account balance each day at our website at www.unifiedtrust.com or by calling the voice response unit at 1-800-845-5151. Please note that any PIN changes you make on the website will not change your PIN on the voice response unit.

Every effort has been made to ensure the highest degree of accuracy for your account. Please review this statement carefully and notify your plan administrator within 40 days of receipt if you believe there is an error. Thereafter, we will correct the error but cannot accept responsibility for any market fluctuation or related expense.

Under the direction of the Securities Exchange Commission, Mutual Fund Companies are requiring Financial Intermediaries, such as Unified Trust Company, to begin assessing redemption fees for the short-term sale of shares in certain funds. Some of the funds that are offered in your retirement plan may be affected. To review the status of the funds in your account, find any applicable trading fee, and define the period of time that is used by the fund for the calculation of any applicable redemption fee, please refer to the prospectus that is available on line. You can view each prospectus by accessing your account at www.unifiedtrust.com.

Investment Performance

For the period ending 09/30/2006 Investment Options	Total Return		Annualized Total Return			Inception Date	Investment Type
	Qtr.	1 Yr.	3 Yrs.	5 Yrs.	10 Yrs.		
American Funds American Balanced Fund (A)	4.49%	8.85%	9.38%	8.13%	9.75%	01/02/1933	Equities
Am. Century Inflation Adj. Bond Fund (Adv) ⁰³	3.45%	1.34%	4.14%	6.29%	5.91%*	02/10/1997	Fixed Income
Columbia Acorn Fund (Z)	0.47%	9.59%	18.69%	17.13%	14.79%	06/10/1970	Equities
American Funds EuroPacific Growth Fund (A)	4.99%	20.05%	22.88%	15.36%	11.01%	04/16/1984	Equities
American Funds Growth Fund of America (A)	1.45%	9.48%	14.35%	10.15%	13.08%	11/30/1973	Equities
American Funds Income Fund of America (A)	5.62%	13.27%	13.51%	10.49%	10.15%	12/31/1970	Equities
Dodge & Cox Stock Fund	4.82%	14.61%	18.20%	14.06%	14.48%	01/04/1965	Equities
Managers Fremont Bond Fund	3.74%	3.27%	3.88%	5.22%	7.02%	04/30/1993	Fixed Income
Federated Mid-Cap Index Fund	-1.21%	6.09%	14.66%	12.45%	12.63%	11/05/1992	Equities
First American Real Estate Secs. Fund (A)	9.67%	32.19%	28.69%	24.19%	16.45%	09/29/1995	Equities
Janus Growth and Income Fund	1.60%	4.90%	13.33%	6.82%	10.80%	05/15/1991	Equities
UTC Stable Value Trust	1.20%	4.67%	4.56%	4.74%	5.45%*	NA	Stable Value/Money Market
Royce Opportunity Fund (Inv)	-0.07%	11.96%	17.41%	18.62%	17.27%*	11/20/1996	Equities
T. Rowe Price Mid Cap Value Fund (Adv)	5.20%	14.63%	18.64%	NA	21.12%*	09/30/2002	Equities
American Century Income & Growth Fund (Adv) ⁰³	4.83%	7.77%	12.80%	7.75%	8.96%	12/17/1990	Equities
T. Rowe Price Equity Income Fund (Adv)	5.47%	12.46%	14.29%	9.22%	8.59%*	03/31/2000	Equities
Phoenix Insight Small Cap Value Fund (A)	0.60%	4.41%	19.25%	14.78%	NA	08/18/1999	Equities
Keeley Small Cap Value Fund	-6.35%	8.25%	25.05%	19.32%	16.08%	10/01/1993	Equities

Mutual funds are not bank deposits or obligations, are not guaranteed by any bank, and are not insured or guaranteed by the FDIC, The Federal Reserve Board, or any other government agency. Investment in mutual funds involves risk, including possible loss of principal.

Performance quoted is past performance and is not indicative of future results. Investment return and principal value will fluctuate so that an investor's shares, when redeemed, may be worth more or less than their original cost. Performance figures represent an investment made at the beginning of the reporting period. Results for investments made during the report period will differ. Performance information is taken from sources believed to be reliable, but is not guaranteed as to completeness or accuracy.

⁰³ For periods prior to the first full quarter after inception, Investor Class performance has been restated to reflect the expenses of the Advisor Class.

* If no ten-year record is available, return is since inception.

Allocation Analyzer

The information below indicates how your Employer is being invested (New Contribution Allocation) and the current value of your account (Existing Balance Allocation). Review your New Contribution Allocation to ensure these funds and investment categories still match your objectives. Also compare the Existing Balance Allocation to the New Contribution Allocation periodically to determine if your Existing Balance Allocation continues to reflect your objectives. Refer also to the full list of investment options offered by the plan sponsor.

New Contribution Allocation

Not Available

Existing Balance Allocation



- Equities (100.00%)
100.00% American Funds American Balanced Fund (
- Fixed Income (0.00%)
- Stable Value/Money Market (0.00%)

Source Summary			
<i>Source</i>	<i>Total Balance</i>	<i>Vested %</i>	<i>Vested Amount</i>
Employer	\$ 47.80	60%	\$ 28.67
Match	\$ 43.32	60%	\$ 25.98
TOTAL	\$ 91.12		\$ 54.65

Summary Statement Of Activity

Period Covere

	American Funds American Balanced Fund (A)	Total
ADRIAN DOYLE CANLEY		
Units - Start of Period	4.846	
Start of Period Unit Value	\$18.00	
Units - End of Period	4.878	
End of Period Unit Value	\$18.68	
Beginning balance	\$ 87.23	\$ 87.23
Contribution	0.00	0.00
Distribution	0.00	0.00
Dividend	0.62	0.62
Forfeiture	0.00	0.00
Gain/Loss	3.27	3.27
Loan distribution	0.00	0.00
Loan repayment	0.00	0.00
Transfer	0.00	0.00
Ending balance	\$ 91.12	\$ 91.12

THIS SPACE INTENTIONALLY LEFT BLANK



Southern California Edison Company
P.O. Box 600, Rosemead, CA 91771-0001

Visit us at:
www.sce.com

Customer and Service Address
CANLEY, ADRIAN

Date Bill Prepared
Aug 22, 2006
Next Meter Read on or about
Sept 20, 2006

Your Customer Account Number

24-hr. Customer Service
1 (800) 684-8123

Service Account Rotating Outage Rate Schedule
[REDACTED] Group A075 DOMESTIC

Billing summary

Amount of Previous Statement 07/22/06	\$	158.44
Previous Charges Due Immediately	\$	158.44
Current Charges	\$	45.69
Late Pymt Chrg	\$	1.20
Current Amount Due 09/11/06	\$	46.89
Your Total Balance Due	\$	205.33

Your current energy usage

Meter Number	From	To	Usage
ACTUAL READ 208-455535	07/21/06 56868	08/21/06 57265	377 kWh
Usage Comparison	This Year		Last Year
Kilowatt-hour (kWh) used	377.00		No
Number of days	31		Comparable
Average usage per day	12.16		Usage
			2 Years Ago
			No
			Comparable
			Usage

Did you know...

*** * Disconnection of Service Notice * ***

The PRIOR PAST DUE amount shown on the payment stub must be paid today to avoid disconnection. (Your service may already be disconnected by the time you receive this bill.) The PAST DUE amount must be paid by 5PM on the date shown on the payment stub to avoid disconnection.

Late Payment Charge Reminder...

A late payment charge of 0.9% will be applied to the total unpaid balance on your account if full payment is not received by the due date on this bill.

SAVE TIME WITH ONLINE BILLING...

Managing your SCE bills is easy as Online Billing. Sign up now and after 3 months of using Online Billing we'll send you a Starbucks Card loaded with \$5. Take advantage of our online payment options and you'll save on postage. Conditions apply. Go to www.sce.com/ebill for complete details.



Southern California Edison Company
P.O. Box 600, Rosemead, CA 91771-0001

Visit us at:
www.sce.com

Customer and Service Address
CANLEY, ADRIAN

Date Bill Prepared
Aug 22, 2006
Next Meter Read on or about
Sept 20, 2006

Your Customer Account Number
[REDACTED]
24-hr. Customer Service
1 (800) 684-8123

Service Account [REDACTED] Rotating Outage Group A075 Rate Schedule DOMESTIC

Detail of current charges: \$45.69

We provide two ways to look at your current charges:

By usage:

Billing Period - 07/21/06 to 08/21/06 (31 days) - Summer Season

Delivery Related Charges (A)		\$	22.96
Generation Related Charges (B)			22.65

Current Billing Detail Subtotal		\$	45.61
State Tax	377 kWh x \$ 0.00022		0.08

Current Charges Due 09/11/06		\$	45.69
-------------------------------------	--	----	--------------

(A) Delivery Related Charges:			
Basic Charge	31 Days x \$ 0.02200	\$	0.68
Energy Charge:			
Baseline-Summer	112 kWh x \$ 0.03903		4.37
Over Baseline 1%-30%	22 kWh x \$ 0.04089		0.90
Baseline-Summer	204 kWh x \$ 0.06244		12.74
Over Baseline 1%-30%	39 kWh x \$ 0.06244		2.44
DWR Bond Charge	377 kWh x \$ 0.00485		1.83

Delivery Subtotal	377 kWh	\$	22.96
-------------------	---------	----	-------

(B) Generation Related Charges:			
DWR Generation:			
Baseline-Summer	27 kWh x \$ 0.10369	\$	2.80
Over Baseline 1%-30%	5 kWh x \$ 0.10369		0.52
Baseline-Summer	49 kWh x \$ 0.10369		5.08
Over Baseline 1%-30%	9 kWh x \$ 0.10369		0.93
SCE Generation:			
Baseline-Summer	85 kWh x \$ 0.06302		5.36
Over Baseline 1%-30%	17 kWh x \$ 0.08711		1.48
Baseline-Summer	155 kWh x \$ 0.03073		4.76
Over Baseline 1%-30%	30 kWh x \$ 0.05739		1.72

Generation Subtotal	377 kWh	\$	22.65
---------------------	---------	----	-------

Your daily average cost this period is : \$ 1.47

MINUTE ORDER

Case Number 2006037553 M A

People Vs Canley, Adrian Doyle

0 Days from first appearance

Name: Canley, Adrian Doyle Court Room: 11 For: 11/06/06 09:00 AM
Case #: 2006037553 M A Atty Name:
Case Status: Open
Release Status: Released on Own Recognizance (O.R.)
Charging Document: Ball Set Amt:

Defendant Information

Booking Information

Court true name Canley, Adrian D

Docket Dt	Seq	Code	Text
11/06/2006	1	HHELD	<u>Missing Complaint Continued Heard in Courtroom 11 on Nov 06, 2006 at 09:00 AM.</u>
	2	OFJUD	Judge Pumell, Roland N.
	3	OFJA	Judicial Assistant - Thoroughgood, Amy.
	4	FCFTR	Digital recorder - 10:41 AM.
	5	PP	The defendant is present in court.
	6	PPDA	Deputy District Attorney Patel present.
	7	RQCONT	People request for continuance is granted.
	8	CLCONT	Case continued to 12/11/06 at 09:00 AM in Courtroom 11 for Missing Complaint Continued
	9	BLORC	Your release on your own recognizance continues.

I have received a copy of these conditions. I understand and agree to each of the conditions listed above.

Date

Defendant's Signature

Defendant's Telephone #

Defendant's Address

Explained/Translated By

Defendant's City, State and Zip Code

VENTURA POLICE DEPARTMENT

PAGE: 000001

Date: 11/17/06 Time: 17:26

Requested By: MENDEZ, TOM

Incident Number Date Time Type Dispo Address

City Unit

Officers Report Number

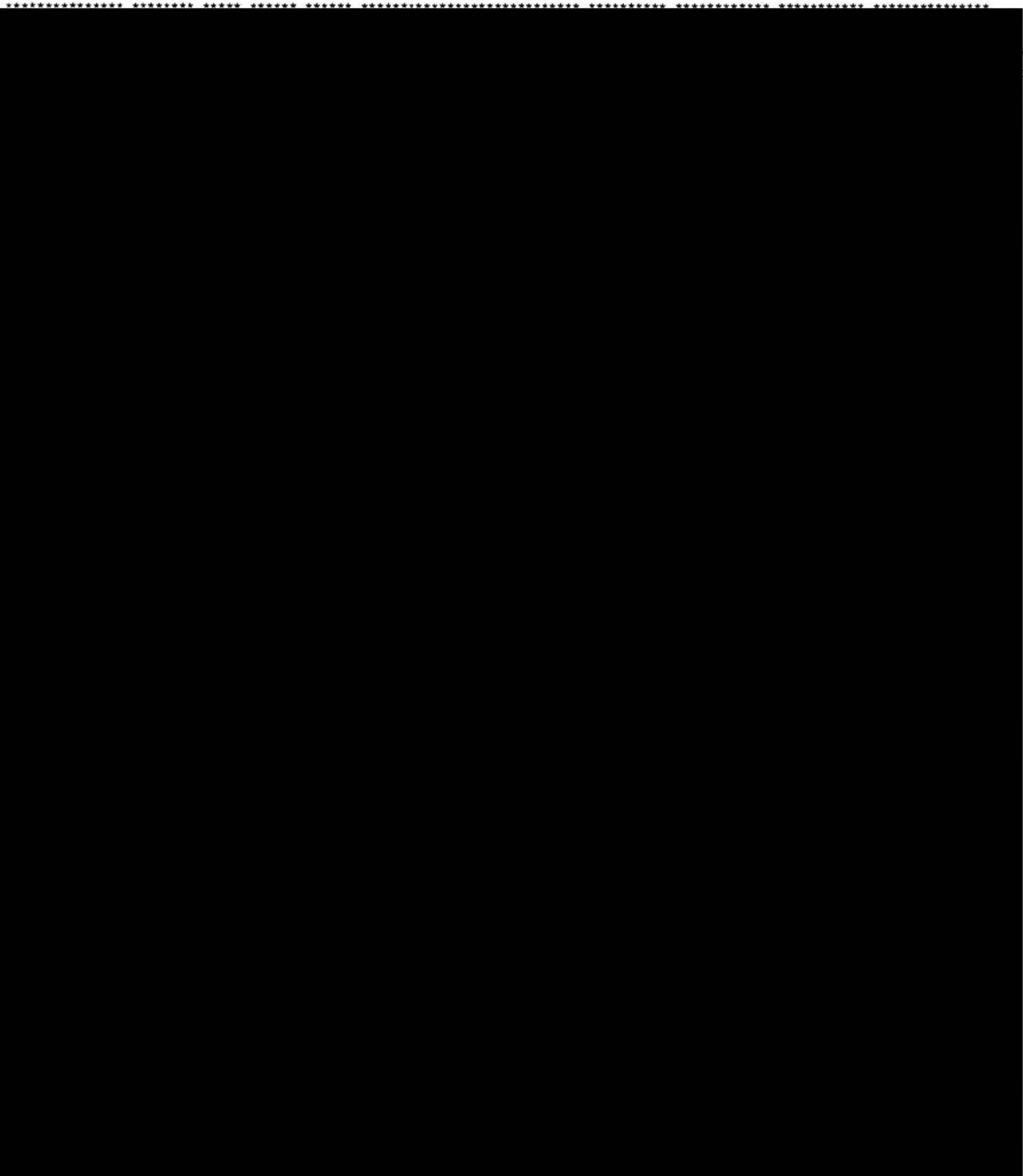

3

INCIDENT RECALL

Incident	Time	Type	Pri	Dispo	Address Location	Bldg Apt	Callers Name Callers Address	P-unit	Close Date/ Time	Operator
----------	------	------	-----	-------	---------------------	----------	---------------------------------	--------	------------------------	----------



==== Vehicle / Subject Information ====

NO VEHICLE OR SUBJECT RECORDS FOR EVENT LVE061112075667.

INCIDENT RECALL

SELECTION CRITERIA:

VEH PLATE :
DATE : 111206 THROUGH 111706
TIME : THROUGH 2359
AGENCY : VE UNIT :
AREA : SECTOR : RESP ZN :
TYPE :
OFFICER :
ADDRESS : XXXXXXXXXX
VICTIM :
FILTER : A
SOURCE CD : , AGENCY ID :

SANTA PAULA POLICE DEPARTMENT

214 SOUTH 10TH STREET
SANTA PAULA, CALIFORNIA 93060
Phone (805) 933-4230
Fax (805) 525-0678

SG0603839
Case Number

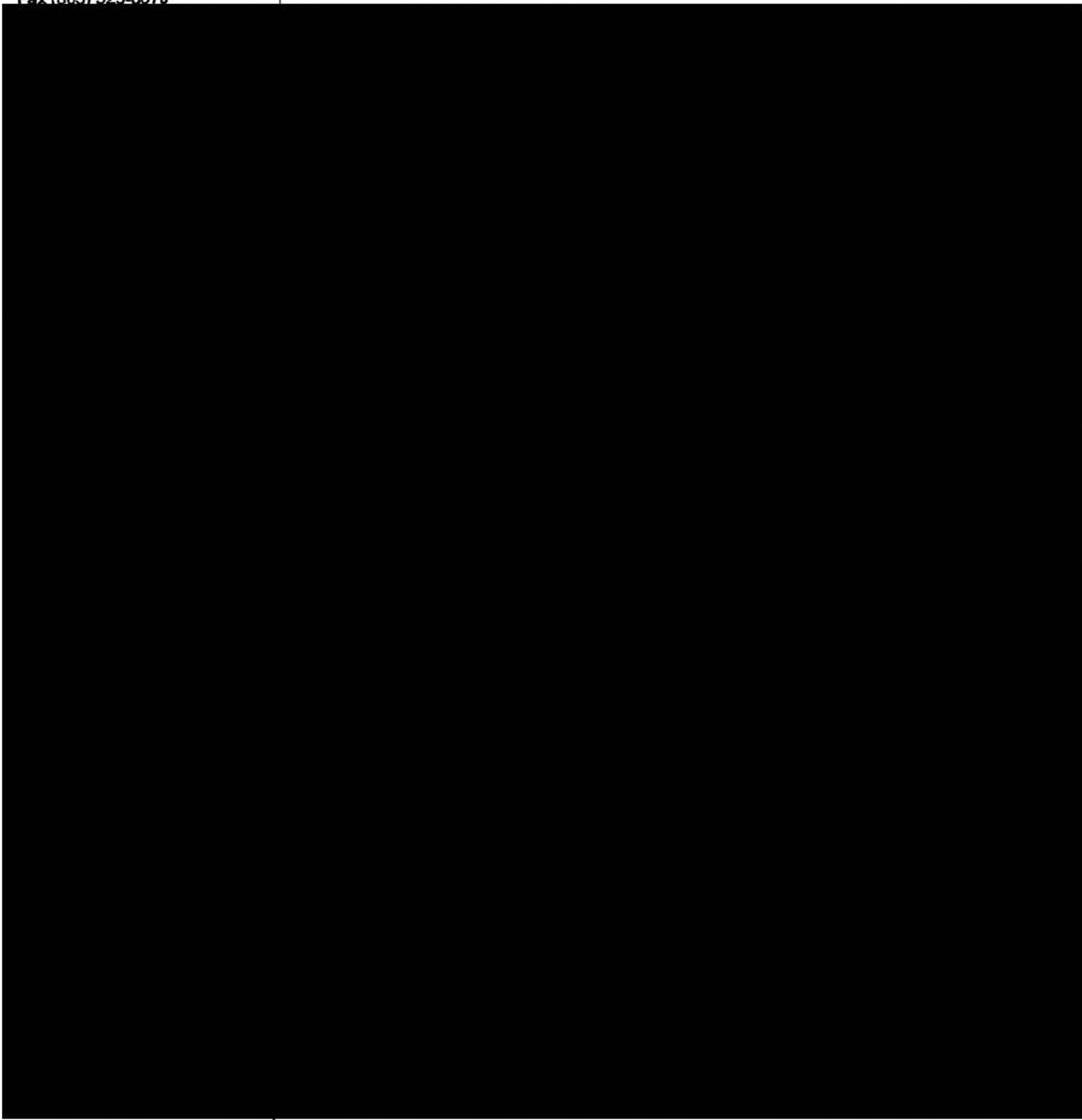

Released By: _____ Received By: _____ Date: _____

11/15/2006 9:15:09AM
Print Date/Time

SANTA PAULA POLICE DEPARTMENT

214 SOUTH 10TH STREET
 SANTA PAULA, CALIFORNIA 93060
 Phone (805) 933-4230
 Fax (805) 525-0678

SG0603839

Case Number

INVESTIGATION	EVIDENCE OBTAINED	SOLVABILITY
<p><input type="checkbox"/> = Dusted For Latents</p> <p><input type="checkbox"/> = Tool Marks Noted</p> <p><input type="checkbox"/> = Vehicle / Shoe Tracks</p> <p><input type="checkbox"/> = Photo Impressions Taken</p> <p><input type="checkbox"/> = Scene Photographed</p> <p><input type="checkbox"/> = Photo(s) Of Victim Taken</p> <p><input type="checkbox"/> = Diagram Of Scene</p> <p><input type="checkbox"/> = Neighbors Contacted</p> <p><input type="checkbox"/> = Area Checked</p> <p><input type="checkbox"/> = Witnesses Contacted</p> <p><input type="checkbox"/> = Victim Contacted</p> <p><input type="checkbox"/> = Other (See Narrative)</p>	<p><input type="checkbox"/> = Finger Prints</p> <p><input type="checkbox"/> = Other Prints</p> <p><input type="checkbox"/> = Weapon / Tools</p> <p><input type="checkbox"/> = Vehicle</p> <p><input type="checkbox"/> = Photos</p> <p><input type="checkbox"/> = Hair</p> <p><input type="checkbox"/> = Stains</p> <p><input type="checkbox"/> = Blood / Semen</p> <p><input type="checkbox"/> = Other (See Narrative)</p> <p><input type="checkbox"/> = None</p> <div style="text-align: center; border: 1px solid black; padding: 2px; width: fit-content; margin: 0 auto;"> Approval APPROVED </div>	<p><input type="checkbox"/> = Was Suspect Arrested</p> <p><input type="checkbox"/> = Can Suspect Be Named</p> <p><input type="checkbox"/> = Can Suspect Be Located</p> <p><input type="checkbox"/> = Can Suspect Be Ident.</p> <p><input type="checkbox"/> = Witness To Crime</p> <p><input type="checkbox"/> = Significant M.O. Present</p> <p><input type="checkbox"/> = Property Traceable</p> <p><input type="checkbox"/> = Significant Evidence</p> <p><input type="checkbox"/> = All Elements Present</p> <p><input type="checkbox"/> = Major Injury or Rape</p> <p><input type="checkbox"/> = Can Suspect be Described</p> <p><input type="checkbox"/> = Can Suspect Vehicle be ID</p> <p><input type="checkbox"/> = Is There Significant Reason to Believe Crime Can be Solved</p>

Copies To

Signature Verifying Original Copy of Case: _____ Date: _____
 Released By: _____ Received By: _____ Date: _____

SANTA PAULA POLICE DEPARTMENT

214 South 10th Street
Santa Paula, CA 93060

CA0560600

Phone (805) 933-4230
Fax (805) 525-0678

Case Number
SG0603839

Date
11/15/06

Officer
MITRE #1035

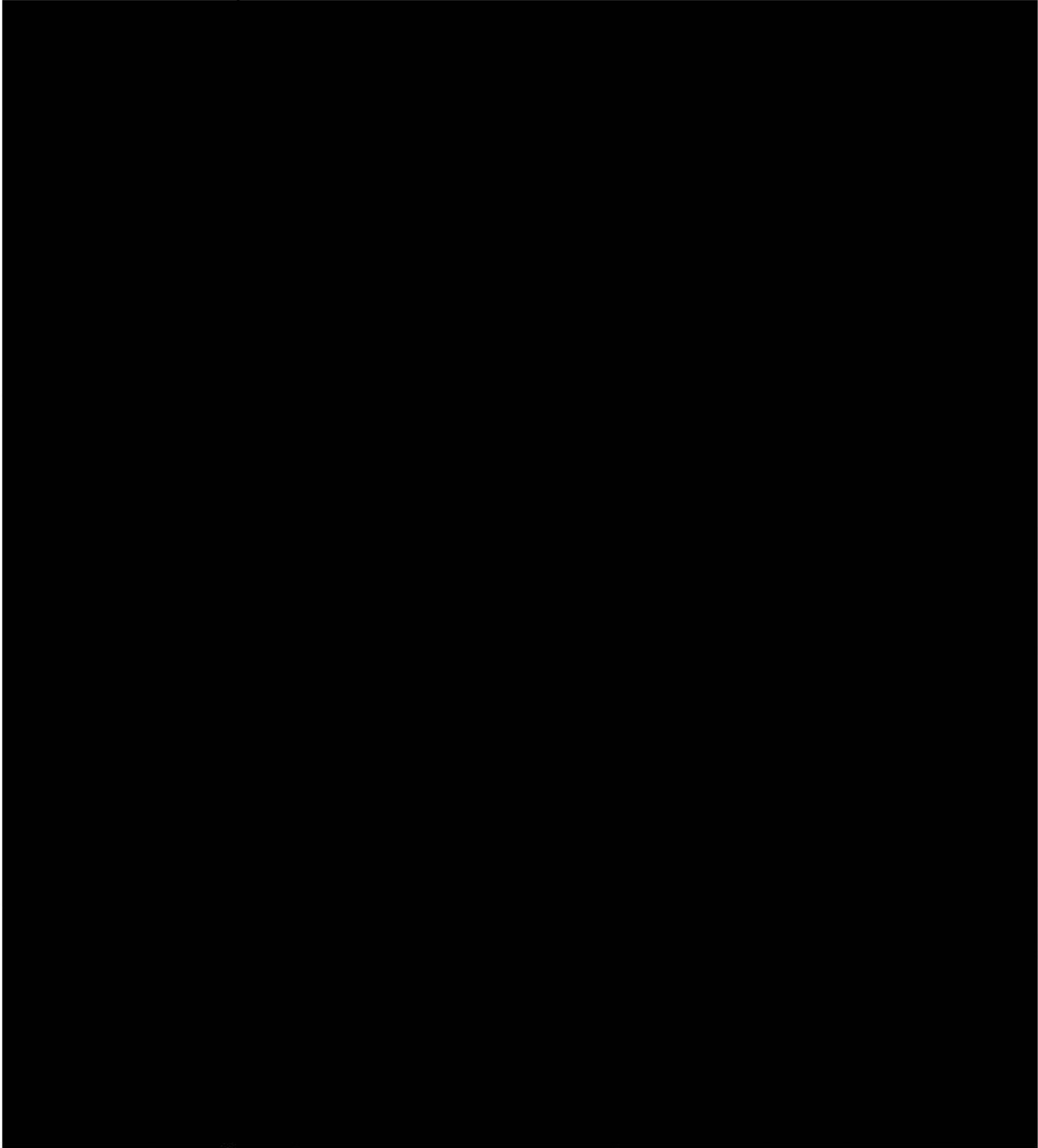

SANTA PAULA POLICE DEPARTMENT

214 South 10th Street
Santa Paula, CA 93060

CA0560600

Phone (805) 933-4230
Fax (805) 525-0678



APPROVED BY: Lt. Saviers #1450

DATE: November 15, 2006

Approved

11/15/2006 09:13 AM

LT. SAVIERS



NARRATIVE REPORT VENTURA COUNTY SHERIFF'S DEPARTMENT

Page 1 of 5 Continuation

AGENCY IDENTIFIER CA0560000

1 RD 9072	2 BEAT 9G01	3 RB NUMBER 06-30492
--------------	----------------	-------------------------

4 CODE	5 ITEM	6 QTY.	7 ITEM NAME	8 BRAND / MAKE MANUFACTURER	9 MODEL NAME OR NUMBER	10 MISC. DESCRIPTION	11 IDENTIFICATION / SERIAL NUMBER	12 VALUE
--------	--------	--------	-------------	-----------------------------	------------------------	----------------------	-----------------------------------	----------

Supplemental Case Cleared

Gang Domestic Hate Child Abuse Elderly Abuse

Connecting Report Numbers:

Code Section / Description: Officer Involved Shooting

Reclassify To:

Code: P Name: Canley, Adrian [REDACTED]

Santa Paula PD Dispatch Recording

On 12/07/06, at about 1345 hours, I met with Sergeant Ismael Cordero at the Santa Paula Police Department. Sergeant Cordero furnished me with a computer printout of the call for service placed to the Santa Paula Police Department by [REDACTED] Canley on 11/14/06. He also provided me with a cassette tape containing a recording of that telephone call. Sergeant Cordero noted that the Santa Paula Police Department's recording system attached the incorrect time of 1837 hours to the telephone call, when in actuality the telephone call was received at 1737 hours.

I examined the call for service report, which identified the call taker as [REDACTED] and the dispatcher as "[REDACTED]". I noticed the report identified the caller as [REDACTED] Canley, [REDACTED] [REDACTED] with a telephone number of [REDACTED]. The "suspect" on the report was listed as Adrian Canley, [REDACTED] driving a white 1999 Ford F-150, Ca license [REDACTED].

I reviewed the audio recording and wrote the following transcript based on the contents of the recording of the telephone conversation between the call taker and [REDACTED] Canley:

13 DATE / TIME OF REPORT 12/08/06/ 4:31 PM	14 REPORTING OFFICER / ID NO / DIV / UNIT Sgt. W. Ayub/#3318/Special Services	15 APPROVED BY / ID NO [Signature] 1917 SA
---	--	---

NARRATIVE REPORT VENTURA COUNTY SHERIFF'S DEPARTMENT

Page 2 of 5 Continuation

AGENCY IDENTIFIER CA0560000

1 RD 9072	2 BEAT 9G01	3 RB NUMBER 06-30492
--------------	----------------	-------------------------

4 CODE	5 ITEM	6 QTY	7 ITEM NAME	8 BRAND / MAKE MANUFACTURER	9 MODEL NAME OR NUMBER	10 MISC. DESCRIPTION	11 IDENTIFICATION / SERIAL NUMBER	12 VALUE
--------	--------	-------	-------------	-----------------------------	------------------------	----------------------	-----------------------------------	----------

CT: Call Taker
 MC: [REDACTED] Canley
 FV: Female voice

CT: Okay ma'm, what are you reporting?
 MC: Okay, my son just left in his car and he sounds schizophrenic and he...he thinks that I know, you know, he thinks people are following him...
 CT: Uh huh
 MC: ...and he just left and he has never talked bad to me but he says I was in it and he could end it all.
 CT: What's the address where you are calling from?
 MC: I'm calling from [REDACTED]...but he...I'm afraid that something bad is gonna happen.
 CT: Last name?
 MC: Canley C-A-N-L-E-Y
 CT: First name?
 MC: [REDACTED]
 CT: What's your phone number?
 MC: Uh...s [REDACTED]
 CT: What's you son's name?
 MC: Adrian.
 CT: Same last name?
 MC: Yes.
 CT: What's his date of birth?
 MC: [REDACTED]
 CT: What kind of car was he in?
 MC: He's in a white pickup um...it's a something like 'F' one fifty or something like that.
 CT: Okay, hold on. 'F' one fifty?
 MC: Yeah, I have...I got his license plate number.

13 DATE / TIME OF REPORT 12/08/06/ 4:31 PM	14 REPORTING OFFICER / ID NO / DIV / UNIT Sgt. W. Ayub/#3318/Special Services BA	15 APPROVED BY / ID NO [Signature] #1917 SG I
---	---	--

NARRATIVE REPORT VENTURA COUNTY SHERIFF'S DEPARTMENT

Page 3 of 5 Continuation

AGENCY IDENTIFIER CA0560000

1 RD	2 BEAT	3 RB NUMBER
9072	9G01	06-30492

4 CODE	5 ITEM	6 QTY	7 ITEM NAME	8 BRAND / MAKE MANUFACTURER	9 MODEL NAME OR NUMBER	10 MISC. DESCRIPTION	11 IDENTIFICATION / SERIAL NUMBER	12 VALUE
--------	--------	-------	-------------	-----------------------------	------------------------	----------------------	-----------------------------------	----------

CT: Okay great, what is it?

MC: [REDACTED]

CT: And is he the registered owner?

MC: Yes.

CT: Is it his car?

MC: Yes.

CT: What year is it? Do you know?

MC: No, it's a new car...a new car.

CT: Which way was he last seen from the house?

MC: I think he's on the freeway by now. He might be on the freeway.

CT: Hold on.

Call taker switches to another incoming telephone call

CT: Santa Paula Police, do you have an emergency?

FV: No, I do not.

CT: Hold on please.

Call taker switches back to the call with [REDACTED] Canley

CT: Which way did he go on Virginia Terrace?

MC: Uh...he went like towards the high school like towards um...Eighth Street.

CT: East or west from you?

MC: Uh...

CT: Fillmore or Ventura?

MC: Ventura.

CT: How long ago did this happen?

MC: About ten minutes ago.

CT: Okay.

MC: They told me to ask for a "TIT" officer.

CT: Who told you?

MC: Uh...when I called the mental health center...because he's...he...he's not...he needs help.

13 DATE / TIME OF REPORT 12/08/06/ 4:31 PM	14 REPORTING OFFICER / ID NO / DM / UNIT Sgt. W. Ayub/#3318/Special Services	15 APPROVED BY / ID NO. [Signature] #1917 SGT
---	---	--

NARRATIVE REPORT VENTURA COUNTY SHERIFF'S DEPARTMENT

Page 4 of 5 Continuation

AGENCY IDENTIFIER CA0560000

1 RD 9072	2 BEAT 9G01	3 RB NUMBER 06-30492
--------------	----------------	-------------------------

4 CODE	5 ITEM	6 QTY	7 ITEM NAME	8 BRAND / MAKE MANUFACTURER	9 MODEL NAME OR NUMBER	10 MISC DESCRIPTION	11 IDENTIFICATION / SERIAL NUMBER	12 VALUE
--------	--------	-------	-------------	-----------------------------	------------------------	---------------------	-----------------------------------	----------

CT: Do you know if he took his medication today?
 MC: No, he's not taking medication.
 CT: So, he doesn't take medication...
 MC: No.
 CT: ...at all?
 MC: ...'cause he's never been like this. This...this is the first time.
 CT: Does he have any weapons on him? Hello.
 MC: Yes.
 CT: Did he have any weapons on him?
 MC: Yes, he does. He has a gun.
 CT: He has a gun in the car?
 MC: With him, in him.
 CT: In the car with him?
 MC: It...on ah the side of his pock, I mean on the, you know, on the side...I saw it, on the side of the pocket...ah, his pants.
 CT: What kind of gun was it?
 MC: I don't know, it's just big.
 CT: What color was it?
 MC: Um, kind of brownish-gray.
 CT: Hold on. How long ago did you talk to him?
 MC: I talked to him about ten minutes ago and then he started cussing at me.
 CT: He left the house ten minutes ago?
 MC: Yeah so that's why I say he probably is in the freeway or going towards the Valley.
 CT: Where does he live?
 MC: Right now he doesn't have a place to stay.
 CT: Who lives in Port Hueneme?
 MC: My daughter.
 CT: He doesn't live there?
 MC: No.

13 DATE / TIME OF REPORT 12/08/06/ 4:31 PM	14 REPORTING OFFICER / ID NO / DIV / UNIT Sgt. W. Ayub/#3318/Special Services	15 APPROVED BY / ID NO <i>[Signature]</i> #1917 SGT
---	--	--

NARRATIVE REPORT VENTURA COUNTY SHERIFF'S DEPARTMENT

Page 5 of 5 Continuation

AGENCY IDENTIFIER CA0560000

1 RD 9072	2 BEAT 9G01	3 RB NUMBER 06-30492
--------------	----------------	-------------------------

4 CODE	5 ITEM	6 QTY	7 ITEM NAME	8 BRAND / MAKE MANUFACTURER	9 MODEL NAME OR NUMBER	10 MISC. DESCRIPTION	11 IDENTIFICATION / SERIAL NUMBER	12 VALUE
--------	--------	-------	-------------	-----------------------------	------------------------	----------------------	-----------------------------------	----------

CT: What did he tell you exactly?

MC: He says...ah, he says I know you guys know what's going on...what the people are saying about me and he says I'm gonna end it.

CT: And that was it?

MC: Yes. (INAUDIBLE) he was here for a while and he thought, you know, like every car that passes by he thinks they're after him.

CT: He has schizophrenia?

MC: That's what it seems like because, you know, he's just paranoid.

CT: Okay, we're gonna go ahead and have officers check the area and then we'll contact you.

MC: Okay but please if you catch him don't tell him I called 'cause I'm afraid.

CT: Oh okay.

MC: Okay.

CT: Thank you.

MC: Okay, thank you.

CT: Bye

MC: Bye

I later booked the cassette tape containing the recording of the telephone conversation into evidence at the headquarters property room. For additional details, refer to the attached copy of the SPPD CFS report and/or the recording of the telephone conversation.

13 DATE / TIME OF REPORT 12/08/06/ 4:31 PM	14 REPORTING OFFICER / ID NO / DIV / UNIT Sgt. W. Ayub/#3318/Special Services <i>BA</i>	15 APPROVED BY / ID NO <i>[Signature]</i> #1917SG1
---	--	---

CFS Detailed Report

Print Date Time
12/6/2006

With Responding Unit Times and Associated Unit Activity

Page 1 of 1

Date of Call 11/14/2006		CFS Number 0038		Time Taken 17:37:51		Nature of Call SUICIDAL SUBJECT			Activity SUIC		Agency S				
Shift B		Call Type A		How Received P		Call Taker [REDACTED]		Dispatcher [REDACTED]		Priority 1		Area 2			
[REDACTED]										Cross Street					
Reporting Party Name (Last Name, First) CANLEY [REDACTED]															
821		VIRGINIA E		ST		SANTA PAULA			Press Board Y		Daily Log Y				
Suspect Information (Last Name, First Name) CANLEY ADRIAN [REDACTED]						State CA		Yeh Yr 1999	Color WHITE		Make FORD		Model F150		
Misc Information CLEAR / VALID						200611140038						Case Number G0603839		Disposition REPORT	
	Recvd.	Disp.	1st to Arrive	last to Clear	Rec/Disp.	Rec/Arrive	Disp./Arrive	Disp./Clear	Unit 1	Unit 2	Unit 3	Unit 4			
	17:37:51	17:44:47	17:48:55	18:00:40	00:06:56	00:11:04	00:04:08	00:15:53	444	423	433				
Unit	Recvd.	Disp.	Arrived	Cleared	Rec/Disp.	Rec/Arrive	Disp./Arrive	Disp./Clear							
423	17:37:51	17:44:47	17:48:55	17:54:16	00:06:56	00:11:04	00:04:08	00:09:29							
444	17:37:51	17:44:47	17:48:56	18:00:40	00:06:56	00:11:05	00:04:09	00:15:53							
433	17:37:51	17:48:58	17:48:58	18:00:40	00:11:07	00:11:07	00:00:00	00:11:42							



1334212 TIME ON DICTAPHONE 18:37:Hours

CRIME REPORT INCIDENT REPORT

CASE NO. 06-10313

REPORT INFORMATION

- NO PROSECUTION DESIRED
- HATE CRIME
- GANG INVOLVED
- CRIME-ONLY
- CRIME/ARREST
- CRIME/SUSPECT
- COURTESY REPORT
- DOMESTIC VIOLENCE
- W & I 300/601 INVOLVED

BEAT 2 RD

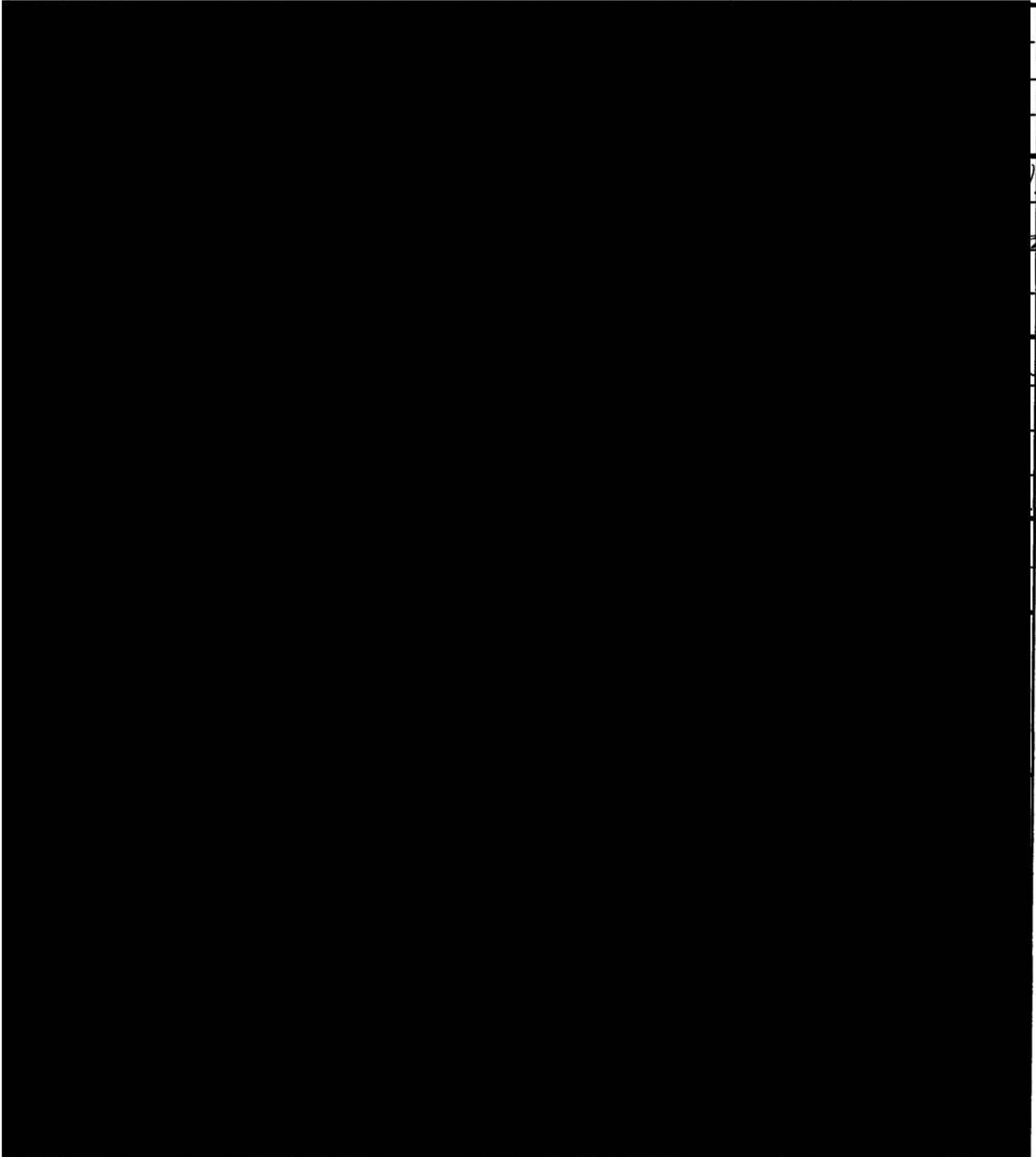

DATE / TIME REPORTED 11-14-06 1829	REPORTING OFFICER / ID NO. N. PRECIADO #344	REVIEWING SUPERVISOR / ID NO. 4-MAN #246	DATE 11/15/06	RMS:
COPIES TO: <input type="checkbox"/> PATROL <input type="checkbox"/> DET <input type="checkbox"/> CAJ <input type="checkbox"/> GANG <input type="checkbox"/> SRO <input type="checkbox"/> STOREFRONT <input type="checkbox"/> DMV <input type="checkbox"/> DOJ <input type="checkbox"/> PROB <input type="checkbox"/> PAROLE <input type="checkbox"/> OTHER				

INCIDENT FACTORS

PAGE _____ OF _____

CASE NO. _____

PREMISES	POINT OF ENTRY	WEAPON TYPE	SUSPECT'S ACTIONS/PROPERTY
<input type="checkbox"/> 01 Airport <input type="checkbox"/> 02 Apartment <input type="checkbox"/> 03 Bank/Savings/Credit Union <input type="checkbox"/> 04 Bar/Lounge <input type="checkbox"/> 05 Bus Station/Bus <input type="checkbox"/> 06 Casino <input type="checkbox"/> 07 Church <input type="checkbox"/> 08 Condo/Townhouse <input type="checkbox"/> 09 Construction Site <input type="checkbox"/> 10 Convenience Store <input type="checkbox"/> 11 Convention Facility <input type="checkbox"/> 12 Fast Food Restaurant <input type="checkbox"/> 13 Fenced Yard <input type="checkbox"/> 14 Garage/Carport <input type="checkbox"/> 15 Gas/Service Station <input type="checkbox"/> 16 Grocery Store <input type="checkbox"/> 17 Hospital <input type="checkbox"/> 18 Hotel/Motel <input type="checkbox"/> 19 Industrial Complex <input type="checkbox"/> 20 Jail/Prison <input type="checkbox"/> 21 Lake/Waterway <input type="checkbox"/> 22 Liquor Store <input type="checkbox"/> 23 Medical Office <input type="checkbox"/> 24 Mobile Home <input type="checkbox"/> 25 Mountain Area <input type="checkbox"/> 26 Movie Theater <input type="checkbox"/> 27 Office <input type="checkbox"/> 28 Park <input type="checkbox"/> 29 Public Building <input type="checkbox"/> 30 Rental Storage <input type="checkbox"/> 31 Restaurant <input type="checkbox"/> 32 Retail Business <input type="checkbox"/> 33 School/Child Care <input type="checkbox"/> 34 Shopping Mall <input type="checkbox"/> 35 Single Family Residence <input type="checkbox"/> 36 Sports Complex <input type="checkbox"/> 37 Storeroom/Shed <input type="checkbox"/> 38 Street/Roadway/Alley/Hwy <input type="checkbox"/> 39 Vehicle <input type="checkbox"/> 40 Warehouse <input type="checkbox"/> 99 Other _____	<input type="checkbox"/> 01 Adj. Building <input type="checkbox"/> 02 Basement <input type="checkbox"/> 03 Door <input type="checkbox"/> 04 Duct/Vent <input type="checkbox"/> 05 Floor <input type="checkbox"/> 06 Front <input type="checkbox"/> 07 Garage <input type="checkbox"/> 08 Ground Level <input type="checkbox"/> 09 Rear <input type="checkbox"/> 10 Roof <input type="checkbox"/> 11 Side <input type="checkbox"/> 12 Sliding Glass Door <input type="checkbox"/> 13 Upper Level <input type="checkbox"/> 14 Wall <input type="checkbox"/> 15 Window <input type="checkbox"/> 99 Other _____	<input type="checkbox"/> 01 Altered Stock <input type="checkbox"/> 02 Automatic <input type="checkbox"/> 03 Blue Steel <input type="checkbox"/> 04 Blunt Object <input type="checkbox"/> 05 Bolt Action <input type="checkbox"/> 06 Chrome/Nickel <input type="checkbox"/> 07 Club <input type="checkbox"/> 08 Derringer Type <input type="checkbox"/> 09 Double Barrel <input type="checkbox"/> 10 Explosives <input type="checkbox"/> 11 Fire/Incendiary Devices <input type="checkbox"/> 12 Firearm <input type="checkbox"/> 13 Handgun <input type="checkbox"/> 14 Hands, Fists, Feet, etc. <input type="checkbox"/> 15 Knife/Cutting Instrument <input type="checkbox"/> 16 Motor Vehicle <input type="checkbox"/> 17 Over/Under <input type="checkbox"/> 18 Poison <input type="checkbox"/> 19 Pump <input type="checkbox"/> 20 Revolver <input type="checkbox"/> 21 Rifle <input type="checkbox"/> 22 Sawed Off <input type="checkbox"/> 23 Shoes/Boots <input type="checkbox"/> 24 Shotgun <input type="checkbox"/> 25 Simulated <input type="checkbox"/> 26 Single Shot <input type="checkbox"/> 27 Toy Gun <input type="checkbox"/> 90 None <input type="checkbox"/> 99 Other _____	<input type="checkbox"/> 01 Alarm Disabled <input type="checkbox"/> 02 Arson <input type="checkbox"/> 03 Ate/Drank on Premises <input type="checkbox"/> 04 Cased Location Before Crime <input type="checkbox"/> 05 Cut/Disconnected Phone <input type="checkbox"/> 06 Defecated/Urinated <input type="checkbox"/> 07 Demanded Money <input type="checkbox"/> 08 Fired Weapon <input type="checkbox"/> 09 Had Been Drinking <input type="checkbox"/> 10 Hot Prowl <input type="checkbox"/> 11 Knew Location of Hidden Cash <input type="checkbox"/> 12 Multiple Suspects Indicated <input type="checkbox"/> 13 Placed Property in Sack/Pocket <input type="checkbox"/> 14 Prepared Exit <input type="checkbox"/> 15 Ransacked <input type="checkbox"/> 16 Selective in Loot <input type="checkbox"/> 17 Shut Off Power <input type="checkbox"/> 18 Smoked on Premises <input type="checkbox"/> 19 Took Only Consumables <input type="checkbox"/> 20 Took Victim's Vehicle <input type="checkbox"/> 21 Under Influence Drugs <input type="checkbox"/> 22 Used Lookout <input type="checkbox"/> 23 Used Driver <input type="checkbox"/> 24 Used Match/Candle <input type="checkbox"/> 25 Used Victim's Suitcase/Pillowcase <input type="checkbox"/> 26 Used Victim's Tools <input type="checkbox"/> 27 Vehicle Needed to Remove Property <input type="checkbox"/> 99 Other _____
METHOD OF ENTRY		MEANS OF ATTACK	
<input type="checkbox"/> 01 Admitted - No Force <input type="checkbox"/> 02 Attempt Only <input type="checkbox"/> 03 Bodily Force <input type="checkbox"/> 04 Bolt Cutters/Pliers <input type="checkbox"/> 05 Brick or Rock <input type="checkbox"/> 06 Broke Hole in Wall <input type="checkbox"/> 07 Burned <input type="checkbox"/> 08 Channel Lock/Pipe Wrench/Vice Grips <input type="checkbox"/> 09 Climbed In/Over/Through <input type="checkbox"/> 10 Coat Hanger/Wire <input type="checkbox"/> 11 Concealment <input type="checkbox"/> 12 Cut <input type="checkbox"/> 13 Fraud/Hoax <input type="checkbox"/> 14 Kicked In <input type="checkbox"/> 15 Knob Twist <input type="checkbox"/> 16 Lock Punch <input type="checkbox"/> 17 Open for Business <input type="checkbox"/> 18 Pried/Jimmied <input type="checkbox"/> 19 Removed Louvers <input type="checkbox"/> 20 Saw/Drill <input type="checkbox"/> 21 Screwdriver <input type="checkbox"/> 22 Smash & Grab <input type="checkbox"/> 23 Tire Iron <input type="checkbox"/> 24 Unlocked <input type="checkbox"/> 25 Window Smash <input type="checkbox"/> 99 Other _____	<input type="checkbox"/> 01 Firearm <input type="checkbox"/> 02 Knife/Cutting Instrument <input type="checkbox"/> 03 Other Assaults - Simple Not Aggravated <input type="checkbox"/> 04 Other Dangerous Weapon <input type="checkbox"/> 05 Strong-Arm (Hands, Fists, Feet, etc.) <input type="checkbox"/> 99 Other _____	<input type="checkbox"/> 01 Blindfolded Victim Bound/Gagged/Tied <input type="checkbox"/> 02 Covered Victim's Face <input type="checkbox"/> 03 Forced Victim into Vehicle <input type="checkbox"/> 04 Forced V to Fondle Suspect <input type="checkbox"/> 05 Forced Victim to Move <input type="checkbox"/> 06 Inflicted Injuries <input type="checkbox"/> 07 Made Threats <input type="checkbox"/> 08 Masturbated Self <input type="checkbox"/> 09 Photographed Victim <input type="checkbox"/> 10 Rape by Instrument (Foreign Object) <input type="checkbox"/> 11 Ripped/Cut Clothing <input type="checkbox"/> 12 Searched Victim <input type="checkbox"/> 13 Sodomy <input type="checkbox"/> 14 Struck Victim <input type="checkbox"/> 15 Suggested V Commit Lewd Act <input type="checkbox"/> 16 Suspect Armed <input type="checkbox"/> 17 Suspect Ejaculated <input type="checkbox"/> 18 Suspect Fondled Victim <input type="checkbox"/> 19 Suspect Orally Copulated Victim <input type="checkbox"/> 20 Threatened Retaliation <input type="checkbox"/> 21 Tortured <input type="checkbox"/> 22 Used Demand Note <input type="checkbox"/> 23 Used Victim's Name <input type="checkbox"/> 24 Victim Injured <input type="checkbox"/> 25 Victim Orally Copulated Suspect <input type="checkbox"/> 99 Other _____	
PROPERTY TAKEN		PHYSICAL SECURITY	
<input type="checkbox"/> 01 Alcohol <input type="checkbox"/> 02 Bicycles <input type="checkbox"/> 03 Clothes/Furs <input type="checkbox"/> 04 Computer Hardware/Software <input type="checkbox"/> 05 Consumable Goods <input type="checkbox"/> 06 Credit/Debit Cards <input type="checkbox"/> 07 Drugs/Narcotics <input type="checkbox"/> 08 Firearms <input type="checkbox"/> 09 Gambling Equipment <input type="checkbox"/> 10 Household Goods <input type="checkbox"/> 11 Jewelry/Precious Metals <input type="checkbox"/> 12 Livestock <input type="checkbox"/> 13 Money <input type="checkbox"/> 14 Office Type Equipment <input type="checkbox"/> 15 Pending Inventory <input type="checkbox"/> 16 Purses/Handbags/Wallets <input type="checkbox"/> 17 Radios/TVs/VCRs/DVDs <input type="checkbox"/> 18 Recordings Audio/Visual <input type="checkbox"/> 19 Tools <input type="checkbox"/> 20 Vehicle Parts/Accessories <input type="checkbox"/> 99 Other _____	<input type="checkbox"/> 01 N/A <input type="checkbox"/> 02 Audible Alarm <input type="checkbox"/> 03 Auxiliary Locks (Deadbolt, Windows, etc.) <input type="checkbox"/> 04 Dog <input type="checkbox"/> 05 Garage Door Locked <input type="checkbox"/> 06 Inside Lighting On <input type="checkbox"/> 07 Obscured Interior View (Commercial/Business) <input type="checkbox"/> 08 Outside Lighting On <input type="checkbox"/> 09 Private Security Patrol <input type="checkbox"/> 10 Security Signage (N.W., Alarm, etc.) <input type="checkbox"/> 11 Silent Alarm <input type="checkbox"/> 12 Standard Locks <input type="checkbox"/> 13 Window Bars/Grills <input type="checkbox"/> 99 Other _____		
VEHICLE ENTRY		SUSPECT'S ACTIONS/PERSONS	
<input type="checkbox"/> 01 N/A <input type="checkbox"/> 02 Door/Lock Forced <input type="checkbox"/> 03 Trunk Forced <input type="checkbox"/> 04 Unlocked <input type="checkbox"/> 05 Window Broken/Smashed <input type="checkbox"/> 06 Window Forced <input type="checkbox"/> 07 Window Open <input type="checkbox"/> 99 Other _____	<input type="checkbox"/> 01 Blindfolded Victim Bound/Gagged/Tied <input type="checkbox"/> 02 Covered Victim's Face <input type="checkbox"/> 03 Forced Victim into Vehicle <input type="checkbox"/> 04 Forced V to Fondle Suspect <input type="checkbox"/> 05 Forced Victim to Move <input type="checkbox"/> 06 Inflicted Injuries <input type="checkbox"/> 07 Made Threats <input type="checkbox"/> 08 Masturbated Self <input type="checkbox"/> 09 Photographed Victim <input type="checkbox"/> 10 Rape by Instrument (Foreign Object) <input type="checkbox"/> 11 Ripped/Cut Clothing <input type="checkbox"/> 12 Searched Victim <input type="checkbox"/> 13 Sodomy <input type="checkbox"/> 14 Struck Victim <input type="checkbox"/> 15 Suggested V Commit Lewd Act <input type="checkbox"/> 16 Suspect Armed <input type="checkbox"/> 17 Suspect Ejaculated <input type="checkbox"/> 18 Suspect Fondled Victim <input type="checkbox"/> 19 Suspect Orally Copulated Victim <input type="checkbox"/> 20 Threatened Retaliation <input type="checkbox"/> 21 Tortured <input type="checkbox"/> 22 Used Demand Note <input type="checkbox"/> 23 Used Victim's Name <input type="checkbox"/> 24 Victim Injured <input type="checkbox"/> 25 Victim Orally Copulated Suspect <input type="checkbox"/> 99 Other _____		

INCIDENT REPORT

THREATS
PRECIADO/349

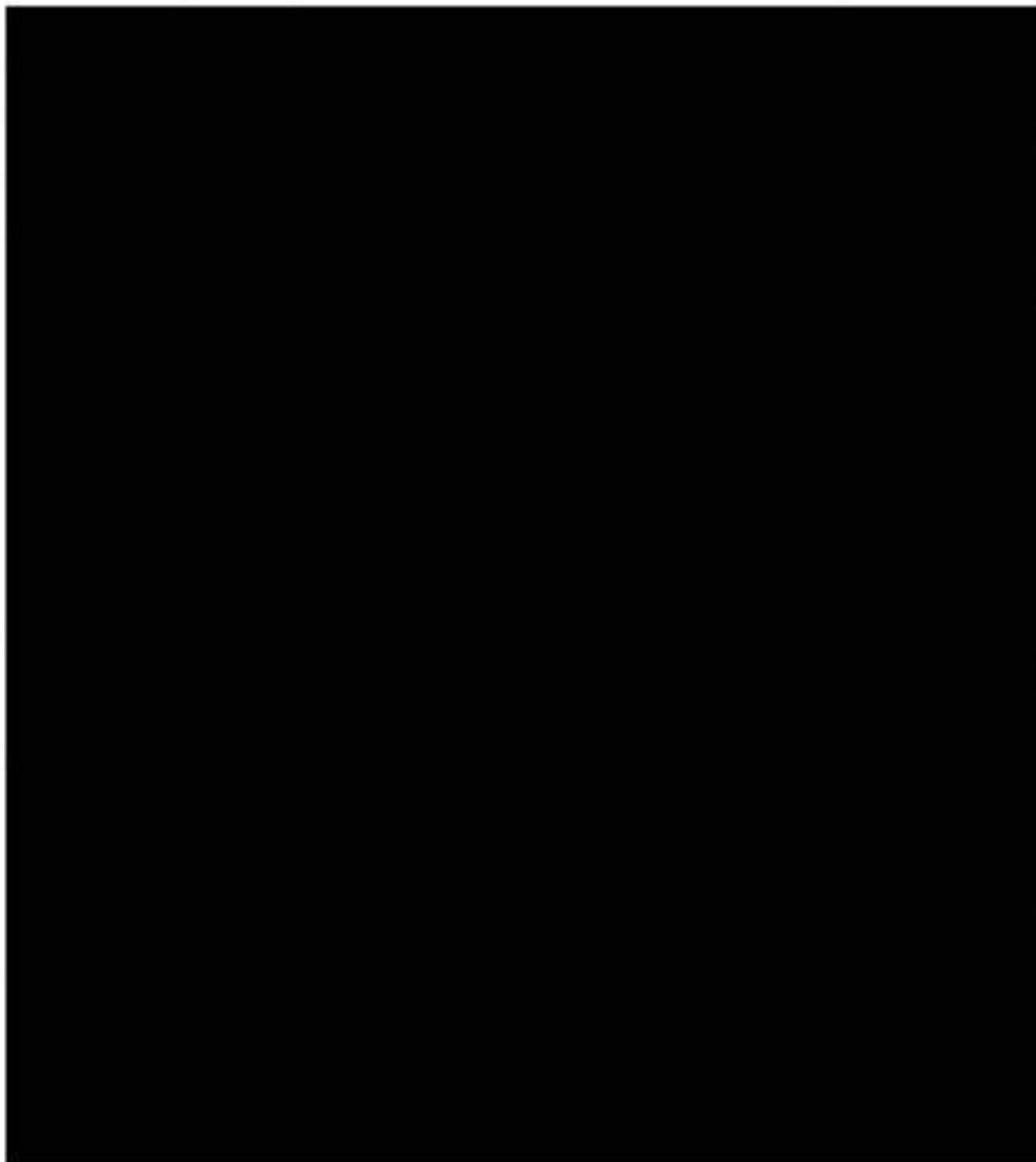

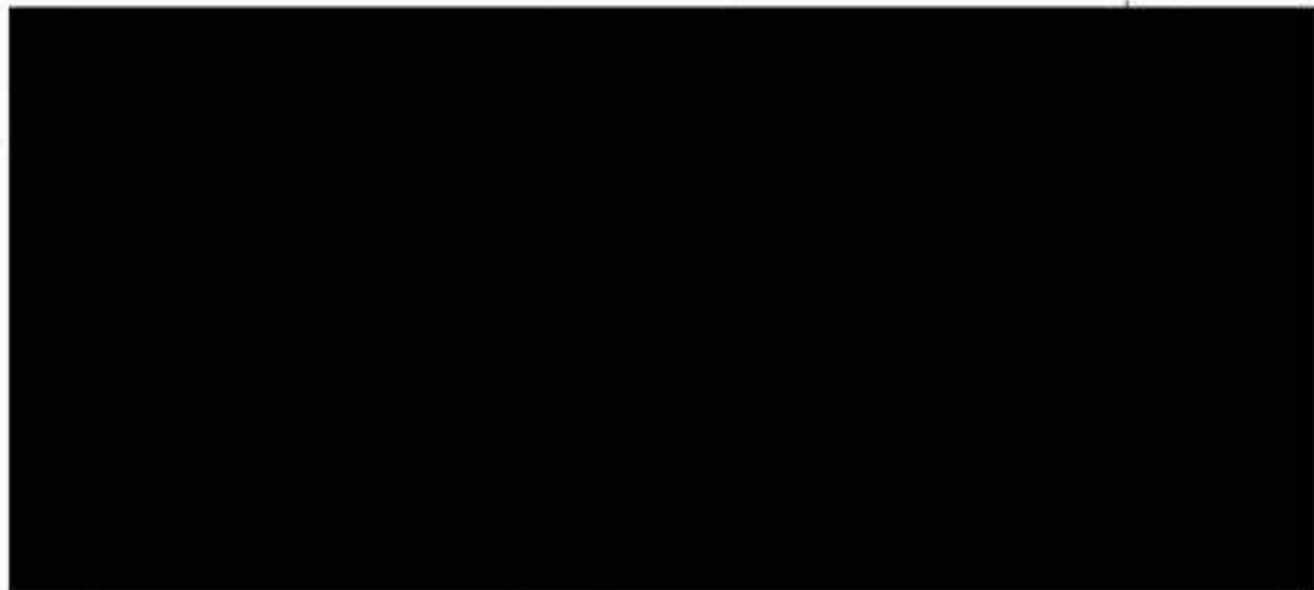

P344
111506/0847 HRS

VENTURA POLICE DEPARTMENT

Date: 11/17/06 Time: 17:23

PAGE: 000001

Requested by: QUINN, JENELLE

INCIDENT RECALL

Incident	Time	Type	Pri	Dispo	Address			Bldg Apt	Callers Name	P-unit	Close	
					Location	Beat	Team/Dist				Area	Date/
					Location			Callers Address		Time		
					Beat Team/Dist Area			Callers Phone				
06-077155	18:29	ACA	2	RTPRM	[REDACTED]				SANTA PAULA	VE/2C1	06/11/14	VE257
					2	B2	DAT					

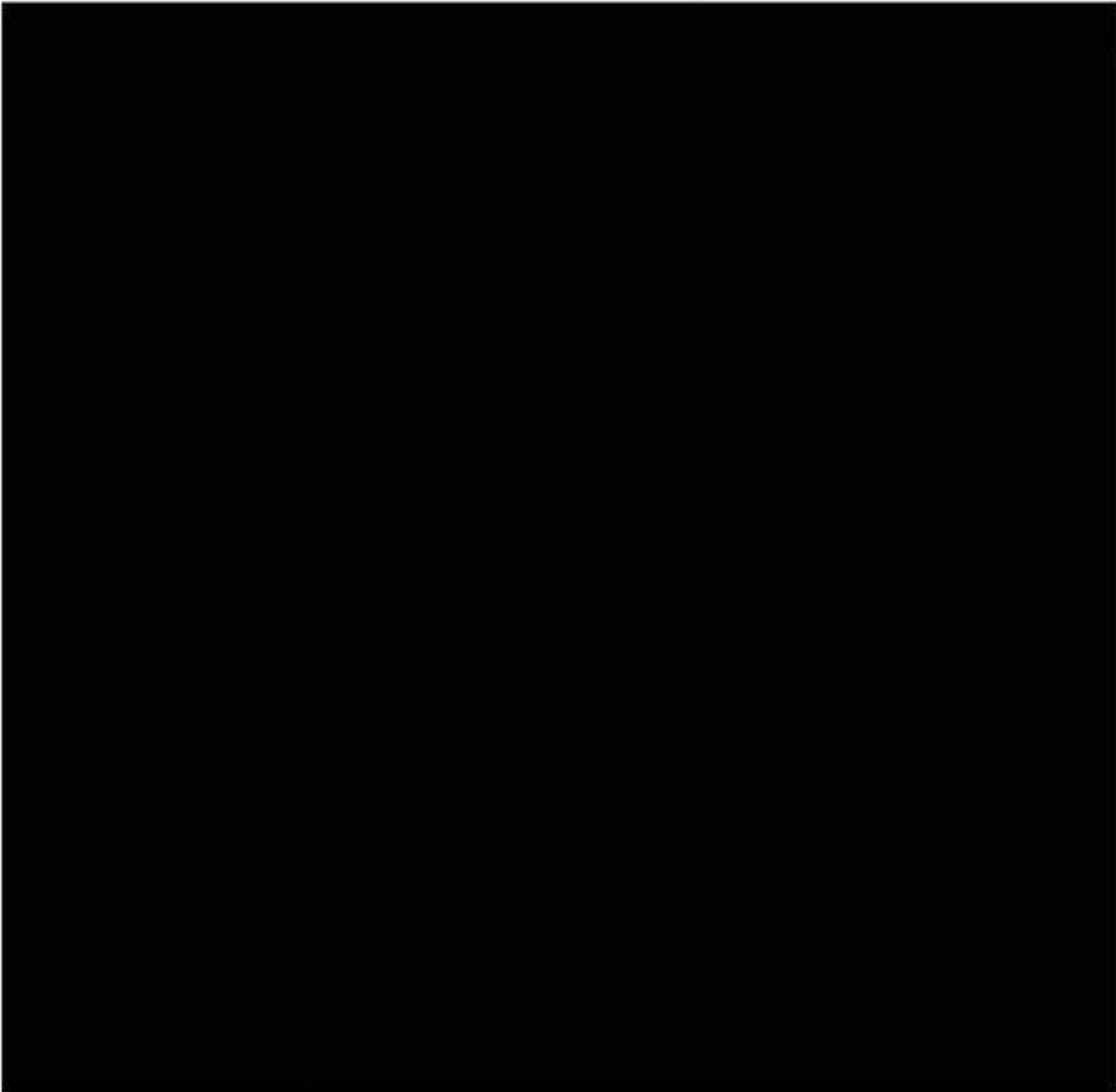

Date: 11/17/06 Time: 17:23

Requested By: QUINN, JENELLE

INCIDENT RECALL

Incident	Time	Type	Pri	Dispo	Address	Blgd Apt	Callers Name	P-unit	Close Date/	Operator
----------	------	------	-----	-------	---------	----------	--------------	--------	-------------	----------



==== Vehicle / Subject Information ====

NO VEHICLE OR SUBJECT RECORDS FOR EVENT LVE061114077155.

NARRATIVE REPORT VENTURA COUNTY SHERIFF'S DEPARTMENT

Page 1 of 10

Continuation

AGENCY IDENTIFIER CA0560000

1 RD 9072	2 BEAT 9D01	3 RB NUMBER 2006-030492
---------------------	-----------------------	-----------------------------------

4 CODE	5 ITEM	6 QTY.	7 ITEM NAME	8 BRAND / MAKE MANUFACTURER	9 MODEL NAME OR NUMBER	10 MISC. DESCRIPTION	11 IDENTIFICATION / SERIAL NUMBER	12 VALUE
--------	--------	--------	-------------	-----------------------------	------------------------	----------------------	-----------------------------------	----------

Supplemental Case Cleared
 Gang Domestic Hate Child Abuse Elderly Abuse

Connecting Report Numbers:

Code Section / Description: OIS

Code: S Name: ██████████, Adrian

Witness Interview



On November 16, 2006, Detective Albert Mesa (ID# 2616) and I drove to ██████████, Ventura, California, to interview ██████████ ██████████. I spoke with ██████████ on the telephone and arranged to speak with her that morning at her residence. Detective Mesa and I arrived at ██████████ residence at about 1020 hours. After greeting ██████████ at the front door of her residence, she invited us inside and we all sat down at the dining room table to talk.

██████████ told us she is Adrian ██████████'s aunt. ██████████ ██████████, Adrian's mother, is ██████████ sister. ██████████ told us that up until three weeks ago she had not spoken with her sister for about two years. ██████████ told us that for the last three weeks ██████████ and Adrian Canley had been living in her apartment with her.

On Sunday, November 12, 2006, Adrian got into a fistfight with another male subject at the apartment complex. After the fight, ██████████ told ██████████ that Adrian could no longer stay in her apartment, and ██████████ has not seen Adrian since that day. ██████████ explained what she knew about the fight for us.

13 DATE / TIME OF REPORT
01/26/2006, 3:00 PM

14 REPORTING OFFICER / ID NO / DIV / UNIT
Sgt. G. Hess, ID# 1917 / Special Services

15 APPROVED BY / ID NO
Sgt. W. J. [Signature] 3318

NARRATIVE REPORT VENTURA COUNTY SHERIFF'S DEPARTMENT

Page 2 of 10

Continuation

AGENCY IDENTIFIER CA0560000

1 RD	2 BEAT	3 RB NUMBER
9072	9D01	2006-030492

4 CODE	5 ITEM	6 QTY.	7 ITEM NAME	8 BRAND / MAKE MANUFACTURER	9 MODEL NAME OR NUMBER	10 MISC. DESCRIPTION	11 IDENTIFICATION / SERIAL NUMBER	12 VALUE
--------	--------	--------	-------------	-----------------------------	------------------------	----------------------	-----------------------------------	----------

At about 2045 hours on Sunday, November 12, 2006, [REDACTED] woke up after hearing a door slam. [REDACTED] said she was sleeping in her bedroom. [REDACTED] explained, "I remember I heard a slam of a door and that woke me up, but I thought that was upstairs. So I was trying to go back to sleep, and then I heard some screaming. 'No Adrian, No!' Then somebody else was screaming something else and I got up. My nephew (Adrian) was at the door and he was mad. And there was another boy with blood on his mouth." I asked [REDACTED] if the other boy was also in her apartment. [REDACTED] explained that Adrian was standing in the threshold of the front doorway and the other subject, whose mouth was bleeding, was standing just outside her apartment. [REDACTED] did not know the subject Adrian fought with.

[REDACTED] continued, "My sister ([REDACTED]) couldn't get him to come in, so I yelled at him real firm, and I go, 'Get in right now!' He got in and he sat right there where that little stuffed animal is." As [REDACTED] spoke she pointed toward the living room. [REDACTED] went on, "He was shaking and he couldn't catch his breath, and I go, 'Relax.' I go, 'What happened?' He just kept going like this, 'I don't know, I don't know,' and shaking. I guess my sister was talking to his dad (Adrian's father) at that time, and he really didn't want to talk to his dad on the phone because he couldn't catch his breath. He was all like - he had a lot of anxiety."

Apparently, [REDACTED] telephoned Adrian's father to tell him about the scuffle. Eventually, Adrian briefly spoke to his father on the telephone. [REDACTED] explained, "I told him, I go, 'Mijo, talk to your dad 'cause he's on the phone...He wants to hear that you're okay.' So he talked to his dad and he told him he would call him back later. And then he said he had to leave. He kept saying, 'I don't want to go to county.' He goes, 'Yeah, they're gonna call the cops, and all the cops are gonna be here. I go, 'What makes you think that?' I go, 'You stay here so that we could know that you're okay.'" [REDACTED] told us Adrian replied, "No, I just gotta go, I just gotta go." [REDACTED] went on, "He just kept saying that...and he left."

I asked [REDACTED] if she knew what started the incident between Canley and the other youth. [REDACTED] replied, "No, I was asleep." [REDACTED] told me she was told the disturbance occurred because of a disagreement over parking. [REDACTED] explained, "My sister said it was something about parking, that

13 DATE / TIME OF REPORT

01/26/2006, 3:00 PM

14 REPORTING OFFICER ID NO / DIV / UNIT

Sgt. G. Hess, ID# 1917 / Special Services

15 APPROVED BY / ID NO

Sgt. W. J. [Signature] 3318

NARRATIVE REPORT VENTURA COUNTY SHERIFF'S DEPARTMENT

Page 3 of 10

Continuation

AGENCY IDENTIFIER CA0560000

1 RD	2 BEAT	3 RB NUMBER
9072	9D01	2006-030492

4 CODE	5 ITEM	6 QTY.	7 ITEM NAME	8 BRAND / MAKE MANUFACTURER	9 MODEL NAME OR NUMBER	10 MISC. DESCRIPTION	11 IDENTIFICATION / SERIAL NUMBER	12 VALUE
--------	--------	--------	-------------	-----------------------------	------------------------	----------------------	-----------------------------------	----------

they had to move a car or something. And my nephew said that the other kid was giving him dirty looks. And then I guess they were both giving each other dirty looks. And I don't know if that time he was upset already or whatever. That's all I know, that they confronted – then I came out, that's all I saw, the kid with..." [REDACTED] words trailed off.

[REDACTED] said the police arrived a short time after the altercation between Adrian and the other male. However, Adrian left the area before the police arrived. I asked [REDACTED] if she knew the identity of the person Adrian fought with, and she told me she did not know his name or where he lived. [REDACTED] said the subject's relatives live somewhere in the apartment complex, and the police talked with the other boy when they arrived at the apartment complex.

Later, [REDACTED] told us that after the fight she told [REDACTED] that Adrian could no longer stay at her residence. [REDACTED] said she was afraid of being evicted because of Adrian's behavior. [REDACTED] said Adrian never returned to her apartment.

I asked [REDACTED] about her relationship with Adrian. [REDACTED] initially stated, "We're very close," but then she added, "I mean, I hadn't seen him for awhile, because – my sister, I haven't even talked to her for like almost two years. But I knew that she was gonna be coming from New York, but I didn't..." [REDACTED] words trailed off. I asked [REDACTED] if Adrian had been in New York with his mother, and she told me, "No, he lived here (in Ventura County). I don't know where he lived, but he lived here." I asked [REDACTED] how often she saw Adrian, and she replied, "We see each other when we have family gatherings."

I asked [REDACTED] if Adrian has had any emotional problems she was aware of. [REDACTED] replied, "He was like a loner...He was a good kid. He was just probably depressed or had problems – I don't know, but he was a really good person. He comes from a good family. I can't say he had problems, because we didn't have that kind of relationship..."

[REDACTED] went on, "When he was here," referring to the period of time Canley recently spent staying at her apartment along with his mother, "I noticed that he was nervous, anxious. I don't know if it was

13 DATE / TIME OF REPORT	14 REPORTING OFFICER / ID / DIV / UNIT	15 APPROVED BY / ID NO
01/26/2006, 3:00 PM	Sgt. G. Hess, ID# 1917 / Special Services	Sgt. W. J. [Signature] 3312

NARRATIVE REPORT VENTURA COUNTY SHERIFF'S DEPARTMENT

Page 4 of 10

Continuation

AGENCY IDENTIFIER CA0560000

1 RD 9072	2 BEAT 9D01	3 RB NUMBER 2006-030492
---------------------	-----------------------	-----------------------------------

4 CODE	5 ITEM	6 QTY.	7 ITEM NAME	8 BRAND / MAKE MANUFACTURER	9 MODEL NAME OR NUMBER	10 MISC. DESCRIPTION	11 IDENTIFICATION / SERIAL NUMBER	12 VALUE
--------	--------	--------	-------------	-----------------------------	------------------------	----------------------	-----------------------------------	----------

cause he wasn't working." Detective Mesa asked if Adrian was behaving nervously before or after the fight. [REDACTED] answered, "After the fight, I thought even more, you know like – he was just anxious."

I asked [REDACTED] again if Adrian had "any mental health issues or problems." [REDACTED] replied, "Did I know? Nuh huh...He was a nice kid. I think he just – you know how some kids think that parents or people are out there to help them?...he was always by himself I think. That's why he felt kind of – like he didn't have older person's support. That's the only problem..." [REDACTED] words trailed off.

I asked [REDACTED] who Adrian was living with after his mother moved to New York. [REDACTED] replied, "I don't know. When I started seeing him like everyday was when they moved here and lived with me." [REDACTED] was referring to when Adrian and his mother moved into her apartment. [REDACTED] added, "That was like two or three weeks ago." I asked [REDACTED] where Adrian's father lives, and she told me he was also living in New York, however, at the time I was talking to her, he was in California.

I asked [REDACTED] why Adrian's mother and father were living in New York. [REDACTED] explained, "They have their own business over there. Their kids were all settled here so – you know they all have their own little life, so they went and they did their own thing with a business in New York." [REDACTED] told me Adrian had been living on his own "for a while" before his parents moved to New York. She said Adrian had an apartment in Oxnard.

[REDACTED] briefly spoke to us about Adrian's daughter ([REDACTED]) and then began talking about her sister, [REDACTED]. [REDACTED] explained, "See, me and my sister – we didn't communicate for two years. And I knew that she was going to be coming from New York because – I don't know if Adrian was in trouble or what, but she was gonna come to help him...I don't know what the issue was or what. I knew through my daughter – because she's real close with her ([REDACTED]) daughter – they're cousins – they're really, really close – so I knew through them – through my daughter that she ([REDACTED]) was gonna be coming. But I didn't think that she was gonna be coming here, because she didn't talk me. When she would come other times she wouldn't acknowledge me in any way."

13 DATE / TIME OF REPORT 01/26/2006, 3:00 PM	14 REPORTING OFFICER ID NO / DIV / UNIT Sgt. G. Hess, ID# 1917 / Special Services	15 APPROVED BY / ID NO SGT. W. J. [Signature] 3318
--	---	--

NARRATIVE REPORT VENTURA COUNTY SHERIFF'S DEPARTMENT

Page 5 of 10

Continuation

AGENCY IDENTIFIER CA0560000

1 RD	2 BEAT	3 RB NUMBER
9072	9D01	2006-030492

4 CODE	5 ITEM	6 QTY.	7 ITEM NAME	8 BRAND / MAKE MANUFACTURER	9 MODEL NAME OR NUMBER	10 MISC. DESCRIPTION	11 IDENTIFICATION / SERIAL NUMBER	12 VALUE
--------	--------	--------	-------------	-----------------------------	------------------------	----------------------	-----------------------------------	----------

I asked [REDACTED] if she had a "falling out" with [REDACTED] before she moved to New York. [REDACTED] responded, "No, we were living together one time, and it just happened, and it didn't workout, so at that time, she left, I left, and then we didn't – our relationship wasn't the same as before. I mean it's like a family thing, but – " [REDACTED] words trailed off.

[REDACTED] was not very forthcoming with information about her dispute with [REDACTED], so I asked again if she had a "squabble" with [REDACTED]. [REDACTED] replied, "Yeah, and then---I mean, I didn't feel I was mad, she didn't feel she was mad, but you know, we just didn't communicate. She didn't communicate with me, and I have my own life that I have to keep going, so I just kept going."

[REDACTED] then returned to talking about when her sister arrived from New York. [REDACTED] said, "The only reason they got a hold of me was because my sister ([REDACTED]) called my son." [REDACTED] said that after she came back into contact with her sister they began communicating again. I asked [REDACTED] if [REDACTED] talked with her about the reason she returned from New York to take care of Canley. [REDACTED] told me, "No, she wasn't very open. All I was doing was giving him room and board and that's it. The only time I would cross words with her (is) when I would get up and go to work, 'cause I was hardly here."

I asked [REDACTED] if she talked with Adrian at all. [REDACTED] replied, "Yeah, I did, because he would be here." Later however, after [REDACTED] had been talking for several moments, I asked [REDACTED] if she talked with Adrian about what had been going on in his life. [REDACTED] responded, "No, I didn't talk to him that much. I just would say 'hi', and just the basic – you know, 'what are you doing,' or – but that's about it, because I'm hardly here."

[REDACTED] then told us about an incident that occurred in her apartment early in the morning on Sunday, November 12, 2006. [REDACTED] explained, "But Sunday morning like about 5 (am) – it was about 4:30 (am) – I was by myself and then I – I leave the door open in my room so I could hear noises. So I heard, and I heard somebody say, 'Shhh, be quiet. Be quiet.' And...I heard his (Adrian's) voice, but I thought he was talking to his little girl or my sister because...that...from the

13 DATE / TIME OF REPORT	14 REPORTING OFFICER (NO. / DIV. / UNIT)	15 APPROVED BY / I.D. NO.
01/26/2006, 3:00 PM	Sgt. G. Hess, ID# 1917 / Special Services	Sgt. W. J. [Signature] 3318

NARRATIVE REPORT VENTURA COUNTY SHERIFF'S DEPARTMENT

Page 6 of 10

Continuation

AGENCY IDENTIFIER CA0560000

1 RD 9072	2 BEAT 9D01	3 RB NUMBER 2006-030492
---------------------	-----------------------	-----------------------------------

4 CODE	5 ITEM	6 QTY.	7 ITEM NAME	8 BRAND / MAKE MANUFACTURER	9 MODEL NAME OR NUMBER	10 MISC. DESCRIPTION	11 IDENTIFICATION / SERIAL NUMBER	12 VALUE
--------	--------	--------	-------------	-----------------------------	------------------------	----------------------	-----------------------------------	----------

door you could see I was asleep. And then I heard all the doors open and close, open and close and then I heard somebody over here," referring to the kitchen area.

████████ continued, "I woke up and I go (thought), 'What's going on?' So then I put my head up and I go (thought), 'Maybe he brought a girl.' But then I saw him in my door, and he called me 'Tia'. Tia is aunt in Spanish. And he goes, 'Tia'. And I go, 'What Mijo?' And he says, 'There's somebody in the house. I know there's somebody in the house.' And I go, 'What? What are you talking about?' (And he said), 'Yeah, somebody's here. Somebody keeps following me. Somebody's here.' And I go, 'No Adrian.' I go, 'Nobody's here.' And he was like shifting his eyes and he was like - " ██████████ words trailed off.

I asked ██████████ if she meant Adrian was looking for someone when she said he was "shifting his eyes," and she responded, "Un huh! And real nervous." ██████████ told us she got up and checked the door to the residence to ensure it was locked and looked around the apartment to reassure Adrian. ██████████ explained she also checked the closet, bathroom, and other rooms and made sure all the windows were locked to show Adrian no one was in the residence but the two of them. ██████████ said Magdalena had not stayed at the residence that night.

████████ then told Adrian to go to sleep. ██████████ told us that after she checked the entire residence she said to Adrian, "See, nobody's here...and I go, 'Nobody's here.' He goes, 'Yes, I could sense that somebody's here. Somebody's here.' And I go, 'No, go to sleep.' He goes, 'I can't, I can't go to sleep.' He was like real anxious."

████████ explained that Adrian sat on the couch in the living room behaving as if he was looking for someone or waiting for someone to enter the residence. ██████████ went on, "...I got kind of scared because I work with people like that, like schizophrenics and like that at the hospital. And they snap...you don't know what could happen." ██████████ continued urging Adrian to go to sleep. She said, "And I go, 'Well, go to sleep and I'm gonna go to sleep,' and I went to my room and I locked my door."

13 DATE / TIME OF REPORT 01/26/2006, 3:00 PM	14 REPORTING OFFICER / ID NO / DIV / UNIT Sgt. G. Hess, ID# 1917 / Special Services	15 APPROVED BY / ID NO <i>Sgt. W. J. [Signature]</i> 3318
--	---	--

NARRATIVE REPORT VENTURA COUNTY SHERIFF'S DEPARTMENT

Page 7 of 10

Continuation

AGENCY IDENTIFIER CA0560000

1 RD 9072	2 BEAT 9D01	3 FB NUMBER 2006-030492
---------------------	-----------------------	-----------------------------------

4 CODE	5 ITEM	6 QTY.	7 ITEM NAME	8 BRAND / MAKE MANUFACTURER	9 MODEL NAME OR NUMBER	10 MISC. DESCRIPTION	11 IDENTIFICATION / SERIAL NUMBER	12 VALUE
--------	--------	--------	-------------	-----------------------------	------------------------	----------------------	-----------------------------------	----------

██████ told us when she got up later that morning she got ready to go to church. Before leaving the residence she spoke with Adrian again. ██████ said Adrian kept asking for his mother. ██████ told Adrian she thought ██████ was at another sister's (██████) residence. ██████ again told Adrian to go to sleep. She said Adrian responded, "I can't, I'm afraid. I can't, I'm afraid."

I asked ██████ if Adrian told her why he was afraid. ██████ replied, "He just said that somebody was here and he was afraid. He didn't say why, but he said that he was afraid. He was trying to protect himself from something." Detective Mesa asked ██████ if Adrian's daughter was at the residence during this time, and ██████ replied, "No, my sister had her."

██████ said sometime later that day she returned home from church. ██████ continued, "When I came (home) that door right there in the hallway was closed the bathroom door was closed and his room door was open, but he had blankets all over, like real dark." ██████ explained that Adrian had covered the window in this room with blankets. ██████ said Adrian was wearing a hooded sweatshirt and gloves. ██████ asked Adrian if he had been able to sleep. ██████ said he told her, "I can't. I'm gonna try to go to sleep right now."

I asked ██████ if she ever saw Adrian with a gun, and she told me, "No, uh huh. And it's scary 'cause I don't know where he kept it or what."

The next involvement ██████ had related to Adrian was on Tuesday, November 14, 2006. ██████ told us officers from the Ventura Police Department arrived at her residence and warned her that Adrian left her sister's house in Santa Paula in a fit of anger armed with a handgun. ██████ said, "I guess he was like angry when he left my sister's (house) in Santa Paula, and saying that everybody was against him, and that we (his family) knew people were following him. (They said) he was kind of mad and he left. That's when he took off. And I guess he had a threat that he was going to come here. I don't know the story, because the police just came and knocked on my door and asked me if I was okay...That's when she (the police officer) told me that there's a threat that he was gonna come and shoot here and some people upstairs or something."

13 DATE / TIME OF REPORT 01/26/2006, 3:00 PM	14 REPORTING OFFICER / NO / DIV / UNIT Sgt. G. Hess, ID# 1917 / Special Services	15 APPROVED BY / ID NO Sgt. W. J. [Signature] 3318
--	--	--

NARRATIVE REPORT VENTURA COUNTY SHERIFF'S DEPARTMENT

Page 8 of 10

Continuation

AGENCY IDENTIFIER CA0560000

1 RD	2 BEAT	3 RB NUMBER
9072	9D01	2006-030492

4 CODE	5 ITEM	6 QTY.	7 ITEM NAME	8 BRAND / MAKE MANUFACTURER	9 MODEL NAME OR NUMBER	10 MISC. DESCRIPTION	11 IDENTIFICATION / SERIAL NUMBER	12 VALUE
--------	--------	--------	-------------	-----------------------------	------------------------	----------------------	-----------------------------------	----------

██████ told us after the police came to her residence she left and stayed at her daughter's house until it was time for her to go to work. ██████ said when she arrived at work she turned on the television. As she watched the television she heard about a shooting in Thousand Oaks. Later, ██████ learned that Adrian was involved in the shooting.

As we continued to talk ██████ told us, "I told my sister – I go, 'He has – something's wrong with him.' I go, 'He's schizophrenic.' I go, 'Maybe he has a problem,' because I've never seen him – that's not Adrian. I go, 'It's not Adrian.' Because he was like real quiet and real polite and...hug and kisses...but I've never seen him the way I've seen him these few days, the last few days before – like nervous, like anxious...and he wouldn't look out the window. And then I would hear stories – that umm – and see my sister believed him...She'd only see one thing," meaning that ██████ would believe whatever Adrian told her.

I asked ██████, "In other words, whatever he tells her, she believes that?" ██████ replied, "Uh huh. And the cop – when he came and told her...he goes, 'Ma'am, your son's on drugs. She goes, 'No, he's never done drugs. He's on antibiotics because he's sick.' And then he (the police officer) goes, 'Ma'am, wake up! You've got to stop being in denial.' And when he told her...(I realized) 'Yeah, you know what? Something's going on with Adrian. He needs help.' So that's when she told the cop she needed (phone) numbers to try to help him." ██████ did not specify if this exchange with the police occurred during contacts with the police on Sunday or Tuesday.

I asked ██████ if she noticed whether or not Adrian has lost a lot of weight recently. ██████ replied, "Yeah, he was skinny. He looked thinner than other times – the last time I'd seen him. On his face, you know, his skin." I asked ██████ if she thought, based on his behavior, that Adrian had a drug problem. ██████ replied, "Yeah, I think so...I was telling my sister, 'You know, I see this in the hospital all the time...he kept saying there was people out there and that there's people following him. He had my sister believing that they were following the truck and stuff.'"

I clarified that Adrian was also telling ██████ people were following him, and she replied, "Uh huh...my sister told me some story that one time he went to somewhere on Thompson (in Ventura)

13 DATE / TIME OF REPORT	14 REPORTING OFFICER / ID NO / DIV / UNIT	15 APPROVED BY / ID NO
01/26/2006, 3:00 PM	Sgt. G. Hess, ID# 1917 / Special Services	Sgt. W. J. [Signature] 3318

NARRATIVE REPORT VENTURA COUNTY SHERIFF'S DEPARTMENT

Page 9 of 10

Continuation

AGENCY IDENTIFIER CA0560000

1 PD 9072	2 BEAT 9D01	3 RB NUMBER 2006-030492
---------------------	-----------------------	-----------------------------------

4 CODE	5 ITEM	6 QTY.	7 ITEM NAME	8 BRAND / MAKE MANUFACTURER	9 MODEL NAME OR NUMBER	10 MISC. DESCRIPTION	11 IDENTIFICATION / SERIAL NUMBER	12 VALUE
--------	--------	--------	-------------	-----------------------------	------------------------	----------------------	-----------------------------------	----------

and that there was this lady that kept lasering him." [REDACTED] said she tried to talk to [REDACTED] and explain to her that she should not believe everything Adrian told her when his behavior was so paranoid. [REDACTED] said [REDACTED] was unreasonable when it came to convincing her that Adrian's stories were made up or paranoid. [REDACTED] went on, "I think it's just make up stories, but I could be wrong, 'cause my sister still believes that there were people undercover following him but I don't know why...I don't know why he would be followed."

[REDACTED] also explained that she lost one of her sons. She alluded to the possibility that he may have been a drug user, but she was somewhat evasive about discussing the matter.

[REDACTED] told us she was concerned about who was going to find out she spoke with us. [REDACTED] told us, "When my sister finds out, that's it.. what I think is that my sister – yesterday, she was saying that he (Adrian) left angry. And if he left the way he was here when I found – when he came that day in the morning – he was seeing things. Everybody was against him, everybody."

To clarify, I asked [REDACTED], "The morning that you said he was saying there was people in here, was he telling you that people had been following him and the police were after him?" [REDACTED] replied, "Un huh, he said that they're watching and they were after him, but he said that somebody was in here," referring to her apartment. I asked [REDACTED] if Adrian told her who was watching him and was after him. [REDACTED] responded, "No, one time he did something – he was cooking and I go, 'What are you cooking?' And he goes, 'I'm sorry Tia, I don't want to bring problems to you.' And I go, 'What do you mean?' And then he said, '...If you see people – there was a SWAT car over there and in the mall (referring to the Pacific View Mall) there's a bunch of cops and then right here there's cops.' And I go, 'How do you know they're cops? How do you know they're after you if they're way in the mall?' He goes, 'I don't know, I just know, I just know.' And then he goes, 'if you see people in their cars, I don't know why they're following me.' They were undercover cops to him. I go, 'Mijo, what did you do?' He goes, 'Nothing, I don't know, nothing, they're just following me.'" [REDACTED] went on telling Detective Mesa and me that Adrian was convinced police officers were following him.

[Handwritten signature]

13 DATE / TIME OF REPORT

01/26/2006, 3:00 PM

14 REPORTING OFFICER / ID NO / DIV / UNIT

Sgt. G. Hess, ID# 1917 / Special Services

15 APPROVED BY / ID NO

[Handwritten signature] 3319

NARRATIVE REPORT VENTURA COUNTY SHERIFF'S DEPARTMENT

Page 10 of 10

Continuation

AGENCY IDENTIFIER CA0560000

1 RD	2 BEAT	3 RB NUMBER
9072	9D01	2006-030492

4 CODE	5 ITEM	6 QTY.	7 ITEM NAME	8 BRAND / MAKE MANUFACTURER	9 MODEL NAME OR NUMBER	10 MISC. DESCRIPTION	11 IDENTIFICATION / SERIAL NUMBER	12 VALUE
--------	--------	--------	-------------	-----------------------------	------------------------	----------------------	-----------------------------------	----------

Detective Mesa asked [REDACTED] if it was typical for Adrian to get into a physical fight like the fight he was engaged in on Sunday. [REDACTED] replied, "No..." Mesa asked her if Adrian had an anger management problem. [REDACTED] said it was out of character for Adrian to get into a fight. She said, "Yeah, it wasn't him."

In response to Detective Mesa's questions, [REDACTED] began to talk about the fallout from the fight on Sunday at her apartment complex. [REDACTED] explained, "That day he took off...and then the cops came and they were talking to the boy, but my nephew wasn't here anymore." Mesa asked if Adrian left after the fight so he would not get arrested. [REDACTED] replied, "He said he refused to go to county (jail), he didn't want to go to county, he didn't like county and he was gonna go, and he left."

As we were getting ready to leave the residence, [REDACTED] told us some of Adrian's possessions were still in one of the bedrooms of her apartment. We asked if we could take a look in the room, and [REDACTED] escorted us back to the bedroom. Detective Mesa and I briefly looked around the room but found nothing noteworthy. After thanking [REDACTED] for her time, Detective Mesa and I left the residence.

Detective Mesa's and my interview with [REDACTED] [REDACTED] was recorded on a digital recorder. The recording was saved as evidence and placed with the case file. The quotes in this report are a transcript of the conversation between Mesa, [REDACTED] and me; however, I have made some minor alterations for clarity and ease of reading and omitted some of the extraneous dialog. The content of the statements has not been altered. Refer to the original recording for exact quotes.

13 DATE / TIME OF REPORT	14 REPORTING OFFICER / ID NO / DIV / UNIT	15 APPROVED BY / ID NO
01/26/2006, 3:00 PM	Sgt. G. Hess, ID# 1917 / Special Services	Sgt. W. J. [Signature] 3318

NARRATIVE REPORT VENTURA COUNTY SHERIFF'S DEPARTMENT

Page 1 of 4

Continuation

AGENCY IDENTIFIER CA0560000

1 RD	2 BEAT	3 RB NUMBER
9072	9G01	2006-30492

4 CODE	5 ITEM	6 QTY.	7 ITEM NAME	8 BRAND / MAKE MANUFACTURER	9 MODEL NAME OR NUMBER	10 MISC. DESCRIPTION	11 IDENTIFICATION / SERIAL NUMBER	12 VALUE
--------	--------	--------	-------------	-----------------------------	------------------------	----------------------	-----------------------------------	----------

Supplemental **Case Cleared**

Gang **Domestic** **Hate** **Child Abuse** **Elderly Abuse**

Connecting Report Numbers:

Code Section / Description: Officer Involved Shooting

Reclassify To:

Code: S-1 Name: Canley, Adrian

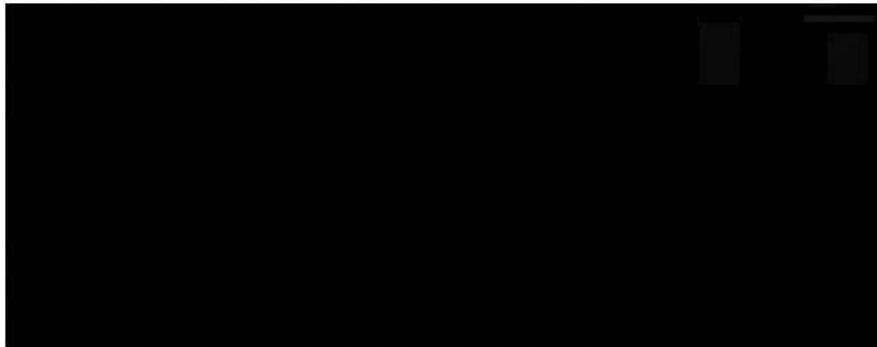

On November 15th 2006, Sergeant Ayub assigned me to contact and interview a subject named [REDACTED]. Sergeant Ayub told me he received information that [REDACTED] had recently been involved in an altercation with (S) Adrian Canley, at an apartment complex in the city of Ventura. This incident took place on November 12th 2006 at approximately 2044 hours.

Sergeant Ayub told me that [REDACTED] called the Ventura Police Department to report this incident. Officers from the Ventura Police Department responded to the scene of the altercation and interviewed [REDACTED]. Canley fled the scene prior to the arrival of the police. [REDACTED] told the police he did not want to file battery charges against Canley. Due to [REDACTED]' decision not to press charges against Canley, this incident was not documented in a written report.

On November 15th 2006 at approximately 1630 hours, I made a telephone call to [REDACTED] at his residence in Oxnard. [REDACTED] was not home at this time, but I spoke with his mother ([REDACTED]) and asked her to have [REDACTED] call me at my office.

13 DATE / TIME OF REPORT	14 REPORTING OFFICER / ID NO / DIV / UNIT	15 APPROVED BY / ID NO
01/17/07/ 2:11 PM	Det. A. Mesa #2616/WCPS/Spl. Svcs.	Sgt. W. J. Ayub 3318

NARRATIVE REPORT VENTURA COUNTY SHERIFF'S DEPARTMENT

Page 2 of 4

Continuation

AGENCY IDENTIFIER CA0560000

1 RD 9072	2 BEAT 9G01	3 RB NUMBER 2006-30492
--------------	----------------	---------------------------

4 CODE	5 ITEM	6 QTY.	7 ITEM NAME	8 BRAND / MAKE MANUFACTURER	9 MODEL NAME OR NUMBER	10 MISC. DESCRIPTION	11 IDENTIFICATION / SERIAL NUMBER	12 VALUE
--------	--------	--------	-------------	-----------------------------	------------------------	----------------------	-----------------------------------	----------

On November █th 2006 at approximately 1410 hours, I received a phone call from █. The following is a summary of my tape-recorded conversation with █.

I told █ I wanted to speak with him about his fight with Adrian Canley. I asked █ if he knew Canley by name. █ said he did not know Canley's name and never met him before this incident. █ confirmed that his altercation with Canley took place on Sunday (11-12-06). I asked █ for his account of the events leading up to the fight. █ said he left work around 9:00 (p.m.) and drove to his aunt's house in Ventura to pick up his sister. █ aunt, █, resides in an apartment at █.

█ said he pulled up in front of his aunt's apartment complex and honked for his sister, █ (█ years), to come outside. █ said he was double-parked in the street with his hazard lights on as he waited for his sister to come out. As █ waited in his vehicle, he observed a subject walking down the street in his direction. *This subject was later identified by VPD as Adrian Canley.* █ said Canley stared at him and started "throwing gang signs" at him. Canley looked at █ and repeatedly asked, "What the fuck are you looking at?"

█ took out his cell phone and dialed his aunt's phone number to tell his sister he was there. █ said Canley started "nodding his head at him" as if to get his attention. █ said he tried to ignore Canley as he continued to wait for his sister. █ said Canley eventually left and disappeared into the apartment complex. █ waited in his truck for approximately 10 more minutes and then decided to go up to his aunt's apartment to get his sister.

As █ was about to climb the stairs to his aunt's apartment, Canley came out of a nearby downstairs apartment and confronted █. Canley asked █, "What's your problem?" █ asked Canley what he wanted. Canley started cursing at █ and told him to move his "fucken piece of shit car", or else he "would run it over." █ told Canley he would move his car after he got his sister. █ said Canley became even more upset because he did not move his vehicle right away.

13 DATE / TIME OF REPORT 01/17/07/ 2:11 PM	14 REPORTING OFFICER / ID NO / DIV / UNIT Det. A. Mesa #2616/W/CPS/Spl Svcs.	15 APPROVED BY / ID NO. Sgt. W. J. [Signature] 3318
---	---	--

NARRATIVE REPORT VENTURA COUNTY SHERIFF'S DEPARTMENT

Page 3 of 4

Continuation

AGENCY IDENTIFIER CA0560000

1 RD	2 BEAT	3 RB NUMBER
9072	9G01	2006-30492

4 CODE	5 ITEM	6 QTY.	7 ITEM NAME	8 BRAND / MAKE MANUFACTURER	9 MODEL NAME OR NUMBER	10 MISC. DESCRIPTION	11 IDENTIFICATION / SERIAL NUMBER	12 VALUE
--------	--------	--------	-------------	-----------------------------	------------------------	----------------------	-----------------------------------	----------

I asked [REDACTED] if he recalled exactly what Canley told him when he confronted him near the stairs. [REDACTED] said Canley told him, "I guess you noticed me. What the fucks' your problem? What were you looking at?" [REDACTED] told Canley he was not looking at anything and was just calling his sister, who was in their aunt's apartment. [REDACTED] said Canley called him a "little bitch" and continued to "go off on him." [REDACTED] said Canley looked "pretty hyper" and thought he was "on something." I asked [REDACTED] if he recalled what Canley was wearing. [REDACTED] said Canley was wearing a light-khaki windbreaker, black pants, white shoes, and black gloves.

Canley quickly retrieved something from his apartment that looked like a zip-up "trapper-keeper" (notebook) or a small briefcase. Canley dropped the notebook on the ground and swung at [REDACTED]. Canley missed and did not initially hit [REDACTED], but [REDACTED] fell back towards the stairs. [REDACTED] said he stood to his feet and Canley swung at him again. [REDACTED] started swinging back at Canley and they fell to the ground where they continued to fight. [REDACTED] said his sister came downstairs after the fight began and screamed when she saw them. [REDACTED] said he exchanged punches with Canley and thought he hit Canley. [REDACTED] said his aunt and uncle ([REDACTED] [REDACTED]) came downstairs and broke up the fight. Canley said he sustained a bloody nose and an injury to his mouth as a result of Canley punching him. [REDACTED] estimated that the fight lasted for approximately five minutes.

I asked [REDACTED] if Canley's aunt or mother came outside after the fight. [REDACTED] said a female subject who appeared to be Canley's mother, came out of her apartment after the fight was over. I asked [REDACTED] where Canley went after the fight was over. [REDACTED] said Canley stood next to his apartment door. [REDACTED] said Canley stormed back into the apartment when his mother confronted him about his behavior. [REDACTED] said his aunt told him she had called the police and [REDACTED] decided to wait for them. I asked [REDACTED] if he saw Canley leave the apartment complex. [REDACTED] said he was washing up when he learned that Canley was leaving the scene. [REDACTED] said he heard a car "peel out" and assumed it was Canley that left. I asked [REDACTED] if he moved his car at some point. [REDACTED] said he gave his uncle his car keys after the fight and his uncle parked his car down the block.

13 DATE / TIME OF REPORT	14 REPORTING OFFICER / ID NO / DIV / UNIT	15 APPROVED BY / SIGNATURE
01/17/07/ 2:11 PM	Det. A. Mesa #2616/WCPS/Spl. Svcs.	Sgt. W. J. [Signature] 3318

NARRATIVE REPORT VENTURA COUNTY SHERIFF'S DEPARTMENT

Page 4 of 4

Continuation

AGENCY IDENTIFIER CA0560000

1 RD	2 BEAT	3 RB NUMBER
9072	9G01	2006-30492

4 CODE	5 ITEM	6 QTY	7 ITEM NAME	8 BRAND / MAKE MANUFACTURER	9 MODEL NAME OR NUMBER	10 MISC. DESCRIPTION	11 IDENTIFICATION / SERIAL NUMBER	12 VALUE
--------	--------	-------	-------------	-----------------------------	------------------------	----------------------	-----------------------------------	----------

I asked [REDACTED] if he recalled what type of vehicles he was parked next to when he initially arrived at his aunt's apartment. [REDACTED] recalled parking next to a white Nissan Sentra and a pickup truck. [REDACTED] thought the truck was possibly grey. [REDACTED] could not provide any further details about the truck.

I asked [REDACTED] if the police asked him if he wanted to press charges against Canley. [REDACTED] said he told the police he did not want to press charges against Canley. I asked [REDACTED] if the police spoke with Canley's mother or aunt. [REDACTED] said he was not sure if the police spoke with Canley's family members.

I asked [REDACTED] about the extent of his injuries. Canley said he felt okay and went to work on the day after the altercation. However, [REDACTED]' employer sent him home because he had a black eye and his face was still a little swollen. I asked [REDACTED] if anyone had photographed his injuries. [REDACTED] said his mother took a picture of his facial injuries with her camera phone, the day after the altercation. [REDACTED] said his mother still had the photograph stored on her camera phone. I asked [REDACTED] to tell his mother not to delete this picture.

I concluded my interview with [REDACTED] and retained the audiocassette as evidence.

End of narrative.

13 DATE / TIME OF REPORT	14 REPORTING OFFICER / ID NO / DIV / UNIT	15 APPROVED BY (ID NO)
01/17/07/ 2:07 PM	Det. A. Mesa #2616/WCPS/Spl Svcs.	Sgt. W. J. [Signature] 3318

NARRATIVE REPORT VENTURA COUNTY SHERIFF'S DEPARTMENT

Page 1 of 8 Continuation

AGENCY IDENTIFIER CA0560000

1 RD 9072	2 BEAT 9G01	3 RB NUMBER 06-30492
--------------	----------------	-------------------------

4 CODE	5 ITEM	6 QTY	7 ITEM NAME	8 BRAND / MAKE MANUFACTURER	9 MODEL NAME OR NUMBER	10 MISC. DESCRIPTION	11 IDENTIFICATION / SERIAL NUMBER	12 VALUE
--------	--------	-------	-------------	-----------------------------	------------------------	----------------------	-----------------------------------	----------

Supplemental Case Cleared

Gang Domestic Hate Child Abuse Elderly Abuse

Connecting Report Numbers:

Code Section / Description: Officer Involved Shooting

Reclassify To:

Code: W Name: Canley, [REDACTED]



On 11/15/06, at about 1328 hours, Detective Rob Davidson #2775 and I drove to [REDACTED] to speak with [REDACTED] Canley concerning the death of her son, Adrian Canley. Adrian was involved in an altercation, on the evening of 11/14/06, with Ventura County Sheriff's Detective Shane Matthews, which resulted in Adrian being shot by Detective Matthews. Adrian later died of the injuries he sustained from the shooting.

I spoke with Senior Deputy Medical Examiner Investigator Craig Stevens earlier in the day, and he told me he spoke with [REDACTED] on the morning of 11/15/06, and already informed her that Adrian was deceased. Investigator Stevens told me that [REDACTED] did not seem surprised at the news of Adrian's death, and she related to him that she was fearful of Adrian's recently increasing paranoia. Stevens also told me that [REDACTED] called the Santa Paula Police Department, on the early evening of 11/14/06, and reported that Adrian left her home armed with a handgun and was possibly en route to a residence in Ventura to shoot someone. According to Investigator Stevens, both Santa Paula PD and Ventura PD filed

13 DATE / TIME OF REPORT 12/20/06/ 3:36 PM	14 REPORTING OFFICER / ID NO. / DIV / UNIT Sgt. W. Ayub/#3318/Special Services <i>BA</i>	15 APPROVED BY / ID NO. <i>J. Dun #1917 SGI</i>
---	---	--

NARRATIVE REPORT VENTURA COUNTY SHERIFF'S DEPARTMENT

Page 2 of 8 Continuation

AGENCY IDENTIFIER CA0560000

1 RD 9072	2 BEAT 9G01	3 RB NUMBER 06-30492
--------------	----------------	-------------------------

4 CODE	5 ITEM	6 QTY	7 ITEM NAME	8 BRAND / MAKE MANUFACTURER	9 MODEL NAME OR NUMBER	10 MISC. DESCRIPTION	11 IDENTIFICATION / SERIAL NUMBER	12 VALUE
--------	--------	-------	-------------	-----------------------------	------------------------	----------------------	-----------------------------------	----------

respective reports on [REDACTED]'s complaint. Refer to Investigator Stevens' report for additional information.

When we arrived at [REDACTED]'s residence, I noted several vehicles parked on the street in front of the residence and on the driveway of the residence. Detective Davidson approached the front door of the residence and was greeted by an unidentified Hispanic female. Detective Davidson asked the woman if she was [REDACTED], and she said she was not. However, the woman opened the door of the residence and invited us inside. As we entered the residence, I saw approximately ten individuals sitting in the living room area. [REDACTED] was one of the people seated in the living room, and she spoke up and identified herself to us. She also indicated that most of the people in the residence were her relatives, and that Adrian's former girlfriend, [REDACTED], was also present.

Detective Davidson asked [REDACTED] if we could speak with her privately and she agreed that we could. Detective Davidson, [REDACTED], and I then walked into a back bedroom of the residence, where we stood and talked. Detective Davidson conducted the bulk of the interview and, in summary, [REDACTED] told us the following.

[REDACTED] told us that she and her husband, [REDACTED] Canley, raised Adrian in San Jose, California. Adrian was a good student and excelled in school. At the time, [REDACTED] was employed by the Phillip Morris Company. On an unknown date, Phillip Morris transferred [REDACTED] to the Southern California area. The transfer prompted the Canleys to move to West Hills, California. Adrian subsequently attended El Camino High School where he received good grades and had many friends. Detective Davidson asked [REDACTED] if Adrian had any discipline problems in high school, and [REDACTED] vaguely referred to "a few" incidents which caused Adrian to be transferred to a high school in Canoga Park. [REDACTED] did not elaborate on the incidents that caused Adrian to transfer high schools.

After high school, Adrian worked for a telemarketing firm in Calabasas. He later went on to work in the construction trade. [REDACTED] said Adrian was a hard worker who was successful and well liked by his employers.

13 DATE / TIME OF REPORT 12/20/06/ 3:36 PM	14 REPORTING OFFICER / ID NO / DIV / UNIT Sgt. W. Ayub/#3318/Special Services	15 APPROVED BY / ID NO <i>G. Blum #7917 SGT</i>
---	--	--

NARRATIVE REPORT VENTURA COUNTY SHERIFF'S DEPARTMENT

Page 3 of 8 Continuation

AGENCY IDENTIFIER CA0560000

1 RD 9072	2 BEAT 9G01	3 RB NUMBER 06-30492
--------------	----------------	-------------------------

4 CODE	5 ITEM	6 QTY.	7 ITEM NAME	8 BRAND / MAKE MANUFACTURER	9 MODEL NAME OR NUMBER	10 MISC. DESCRIPTION	11 IDENTIFICATION / SERIAL NUMBER	12 VALUE
--------	--------	--------	-------------	-----------------------------	------------------------	----------------------	-----------------------------------	----------

About one year ago, Adrian was living with [REDACTED] in Port Hueneme, along with [REDACTED] and Adrian's 2-year-old daughter, [REDACTED]. At this time, [REDACTED] moved away to New York, New York, where she joined [REDACTED], who had moved there about one year earlier.

In August of 2006, after [REDACTED] moved away, Adrian lost his job in the construction field. Detective Davidson asked [REDACTED] why Adrian lost his job, and she told us Adrian was "laid off" by the Union. After losing his job, [REDACTED] helped Adrian financially, and Adrian reluctantly accepted her help. She commented that she has another son who is in college who also requires her financial support, insinuating that Adrian reluctantly accepted her help because he knew it was difficult for [REDACTED] to help him and his brother with their finances. Ultimately, Adrian became financially unable to pay for his apartment, and he was forced to move at the end of September of 2006.

[REDACTED] told us that Adrian complained to her about people following him. She suggested to Adrian that he tell the police about being followed, which he eventually did. [REDACTED] later found out from her sister-in-law that Adrian had been arrested when he went to the police to complain about being followed. [REDACTED] said she did not know why Adrian had been arrested, and she did not tell us when this incident occurred.

[REDACTED] said she decided to return to Ventura County in October of 2006, to help Adrian by watching his daughter while he went and looked for work. Detective Davidson asked [REDACTED] about Adrian's mental condition when she returned to Ventura County. [REDACTED] replied, "To me, he was fine" and she told us that Adrian mostly stayed at home or took his daughter to Chuck E Cheese's to occupy his time.

Detective Davidson asked [REDACTED] if Adrian's concern that people were following him seemed to increase as time went on. [REDACTED] replied, "Well yesterday...yesterday it did." [REDACTED] went on to tell us she called Mental Health, on 11/14/06, in an attempt to seek advice on how to deal with Adrian. According to [REDACTED], whomever she spoke with at Mental Health told her to call 911 and ask for a "CIT" officer. [REDACTED] said she dialed 911 and asked for a CIT officer but she was told that she had to call the Santa Paula Police Department instead.

13 DATE / TIME OF REPORT 12/20/06/ 3:36 PM	14 REPORTING OFFICER / ID NO. / DIV / UNIT Sgt. W. Ayub/#3318/Special Services	15 APPROVED BY / ID NO. <i>[Signature]</i> #9917SGI
---	---	--

NARRATIVE REPORT VENTURA COUNTY SHERIFF'S DEPARTMENT

Page 4 of 8 Continuation

AGENCY IDENTIFIER CA0560000

1 RD 9072	2 BEAT 9G01	3 RB NUMBER 06-30492
--------------	----------------	-------------------------

4 CODE	5 ITEM	6 QTY.	7 ITEM NAME	8 BRAND / MAKE MANUFACTURER	9 MODEL NAME OR NUMBER	10 MISC. DESCRIPTION	11 IDENTIFICATION / SERIAL NUMBER	12 VALUE
--------	--------	--------	-------------	-----------------------------	------------------------	----------------------	-----------------------------------	----------

██████████ told Detective Davidson and I that she telephoned the Santa Paula Police Department and asked for help. An officer from the Santa Paula Police Department later met with ██████████ and obtained her statement for a formal report. In that report, ██████████ referred to a fight Adrian became involved in on Rexford St. in Ventura, and she expressed concern that Adrian might return to Rexford St. and cause a problem.

Before calling the police on 11/14/06, ██████████ and Adrian were having a discussion about his belief that he was being followed. During that conversation, Adrian told ██████████ that he had to drive almost all the way to Bakersfield to evade the people who were following him. ██████████ said she suggested to Adrian that he seek some professional help regarding his belief that he was being followed. Detective Davidson asked ██████████ if she thought Adrian was really being followed. ██████████ replied, "In a way it was". I asked ██████████ if she meant Adrian really believed that he was being followed, and she confirmed that was correct.

Detective Davidson asked ██████████ if she saw Adrian with a gun before he left home on 11/14/06. ██████████ said she did not see a gun but she knew that he had one. Upon further questioning, ██████████ said she saw the outline of what she believed was a handgun tucked in Adrian's pants' waistband, above his right rear hip. She also admitted that she has seen him with a brownish-gray colored handgun in the recent past.

Detective Davidson asked ██████████ to describe Adrian's mental condition when he left home on 11/14/06. ██████████ replied, "Mentally, I had never seen him like that." She elaborated and told us that Adrian was calm but he was continuously looking out the windows, believing that someone was following him. It was during this time, ██████████ suggested to Adrian that he seek some professional help (for his paranoia), which prompted the argument that preceded Adrian leaving the house.

Next, Detective Davidson asked ██████████ if she thought Adrian had been using drugs. ██████████ said she knew that Adrian used marijuana in the distant past, but she did not believe he had used any drugs lately. She said she has spoken with Adrian about whether or not he had used drugs, and he has always denied to her that he has used drugs in the past.

13 DATE / TIME OF REPORT
12/20/06/ 3:36 PM

14 REPORTING OFFICER / ID NO / DIV / UNIT
Sgt. W. Ayub/#3318/Special Services

15 APPROVED BY / ID NO.
S. [Signature] #1917 SGT

NARRATIVE REPORT VENTURA COUNTY SHERIFF'S DEPARTMENT

Page 5 of 8 Continuation

AGENCY IDENTIFIER CA0560000

1 RD 9072	2 BEAT 9G01	3 RB NUMBER 06-30492
--------------	----------------	-------------------------

4 CODE	5 ITEM	6 QTY.	7 ITEM NAME	8 BRAND / MAKE MANUFACTURER	9 MODEL NAME OR NUMBER	10 MISC. DESCRIPTION	11 IDENTIFICATION / SERIAL NUMBER	12 VALUE
--------	--------	--------	-------------	-----------------------------	------------------------	----------------------	-----------------------------------	----------

██████████ said she became especially concerned about Adrian's behavior when they argued on the afternoon of 11/14/06. During that argument, Adrian used profanity in her presence, which she said he had never done in the past. Detective Davidson asked ██████████ if Adrian cursed at her, and she said he did not – he cursed at the situation. ██████████ said that Adrian also accused her of knowing what was going on, insinuating that ██████████ knew why he was being followed. Shortly thereafter, Adrian left the residence and ██████████ telephoned the police.

Detective Davidson asked ██████████ what Adrian told her when he left the house. ██████████ said, "He said that he was tired of it." She said that she tried to counsel Adrian, but he insisted she did not believe that he was being followed. Detective Davidson asked ██████████ if Adrian said "I know how to end this" or "I'm gonna end this." ██████████ said Adrian did make a similar statement before he left the house. Detective Davidson asked ██████████ what she thought Adrian meant by that statement, and she said, "He always says that but, you know, that he was gonna get to the root of the problem." ██████████ confirmed her belief that Adrian felt his problem was that people were following him.

Detective Davidson asked ██████████ if she truly believed that Adrian was being followed or if she simply believed that Adrian believed that he was being followed. ██████████ said, "No, I truly believe it because...because sometimes I would drive his truck and then there was some cars – familiar cars, and also one day I was with my sister...she took me back 'cause...'cause sometimes, you know, since I don't have transportation, she would go and pick me up, and I saw somebody on the corner and they didn't see me 'cause I was in a different car." Detective Davidson asked ██████████ who she thought the people were, and she said she did not know. She commented that Adrian thought the people were police or citizens hired by the police to follow him.

Detective Davidson told ██████████ that he heard there was an incident where Adrian believed that school children were watching and/or following him, and he asked ██████████ if that was true. ██████████ said that was not true, and she had not heard Adrian allege that school children were following him.

13 DATE / TIME OF REPORT
12/20/06/ 3:36 PM

14 REPORTING OFFICER / ID NO / DIV / UNIT
Sgt. W. Ayub/#3318/Special Services

15 APPROVED BY / ID NO
B.A.
B. Allen #1917502

NARRATIVE REPORT VENTURA COUNTY SHERIFF'S DEPARTMENT

Page 6 of 8 Continuation

AGENCY IDENTIFIER CA0560000

1 RD 9072	2 BEAT 9G01	3 RB NUMBER 06-30492
--------------	----------------	-------------------------

4. CODE	5. ITEM	6. QTY	7. ITEM NAME	8. BRAND / MAKE MANUFACTURER	9. MODEL NAME OR NUMBER	10. MISC. DESCRIPTION	11. IDENTIFICATION / SERIAL NUMBER	12. VALUE
---------	---------	--------	--------------	------------------------------	-------------------------	-----------------------	------------------------------------	-----------

Detective Davidson asked [REDACTED] if she knew about any gang affiliation that Adrian had, and he mentioned that Adrian had a number of tattoos on his body. [REDACTED] confirmed that Adrian had many tattoos, but she denied that he had any gang affiliation whatsoever. She claimed that she had never gotten a close look at Adrian's tattoos and she therefore could not describe any of his tattoos.

[REDACTED] described the incident that occurred on Rexford Street in Ventura by explaining that she and Adrian were staying with a relative there. She and Adrian were inside the residence when Adrian started feeling "edgy". [REDACTED] said she suggested to Adrian that he relax, and, in turn, Adrian went to the refrigerator and obtained a beer. Adrian opened the beer but did not drink any. Adrian then announced that he needed to go drive around to calm down, and he left the residence. As he left the residence, Adrian encountered someone who was double-parked in front of their residence. [REDACTED] said Adrian asked the driver of the double-parked vehicle to "please move", and the driver responded with a profane remark.

[REDACTED] said Adrian returned to the residence briefly to get some compact discs, and when he returned to his vehicle the other motorist was still double-parked. At that time, the driver of the vehicle got out and made a remark to Adrian, which caused Adrian to approach him. Adrian and the driver then became involved in a physical fight, which [REDACTED] had to break up. After breaking up the fight, [REDACTED] said the man Adrian fought with approached her and made a comment similar to "It ends with you" to [REDACTED]. [REDACTED] said she felt threatened by the man's comment, and she then decided to go stay with her sister on Virginia Terrace in Santa Paula. A short while later, the Ventura Police arrived at the residence and filled out a report on the incident.

Detective Davidson asked [REDACTED] how many times Adrian had been arrested. [REDACTED] said she knew that Adrian had been arrested on the occasion when he went to the police to complain about being followed, and on one other occasion when he hit a pole with his truck and left the scene. She said she did not know of any other arrests.

Detective Davidson explained to [REDACTED] the circumstances surrounding Adrian's shooting. While we were speaking, an unidentified male knocked on the door and told [REDACTED] her husband was on the telephone and wanted to speak with her immediately.

13. DATE / TIME OF REPORT 12/20/06/ 3:36 PM	14. REPORTING OFFICER / ID NO. / DIV / UNIT Sgt. W. Ayub/#3318/Special Services <i>BA</i>	15. APPROVED BY / ID NO. <i>G. [Signature] #1917 SGT</i>
--	--	---

NARRATIVE REPORT VENTURA COUNTY SHERIFF'S DEPARTMENT

Page 7 of 8 Continuation

AGENCY IDENTIFIER CA0560000

1 RD 9072	2 BEAT 9G01	3 RB NUMBER 06-30492
--------------	----------------	-------------------------

4 CODE	5 ITEM	6 QTY	7 ITEM NAME	8 BRAND / MAKE MANUFACTURER	9 MODEL NAME OR NUMBER	10 MSC. DESCRIPTION	11 IDENTIFICATION / SERIAL NUMBER	12 VALUE
--------	--------	-------	-------------	-----------------------------	------------------------	---------------------	-----------------------------------	----------

██████████ accepted the telephone call and spoke with ██████████ briefly, and she then handed the telephone to Detective Davidson. Detective Davidson explained the circumstances surrounding Adrian's shooting to ██████████, and he returned the telephone to ██████████ when he was done. ██████████ spoke to ██████████ briefly again, and she then ended the telephone call.

I asked ██████████ if she believed that Adrian might have been suicidal. ██████████ said, "He didn't seem suicidal, he just looked paranoid." She said that Adrian had never threatened suicide in the past. ██████████ said Adrian was usually fine when he was around the house but whenever he would go outside, he would return in an agitated stated. Detective Davidson asked ██████████ if Adrian could have been using drugs when he left the house, and she said she did not think that was possible. ██████████ denied there was any history of mental illness in her family.

I asked ██████████ about two bullet holes I noticed in the tailgate of Adrian's pickup truck, which did not appear to be related to the shooting incident with Detective Matthews. ██████████ said she recalled seeing a hole in the "back" of Adrian's truck, but she did not realize it was a bullet hole. She said the hole was in Adrian's truck when she returned from New York in October of 2006. ██████████ did not know why or how the bullet hole came to be in Adrian's truck, and she confirmed that Adrian did not tell her that anyone shot at him.

Detective Davidson asked ██████████ if there were periods of time where Adrian would disappear or not reveal to her where he had been. ██████████ recalled a recent occasion when Adrian left for a weekend, but he told her ahead of time that he would be gone. She thought that he went to stay with a friend in Thousand Oaks during that time, but she was unsure who that person was or where he lived.

Detective Davidson asked ██████████ if Adrian's behavior had created problems within the family, and she denied that it had. ██████████ identified her immediate family as her husband, ██████████ Canley; and her surviving son, ██████████ Canley. ██████████ also told us that Adrian has a two-year-old daughter, whom she identified as ██████████ ██████████ Canley. ██████████ mother is ██████████ ██████████ who was Adrian's long-time girlfriend.

We concluded the interview with ██████████ by providing her with our business cards and contact information.

13 DATE / TIME OF REPORT 12/20/06/ 3:36 PM	14 REPORTING OFFICER / ID NO / DIV / UNIT Sgt. W. Ayub/#3318/Special Services	15 APPROVED BY / ID NO <i>[Signature]</i> #1917
---	--	--

NARRATIVE REPORT VENTURA COUNTY SHERIFF'S DEPARTMENT

Page 8 of 8 Continuation

AGENCY IDENTIFIER CA0560000

1 RD 9072	2 BEAT 9G01	3 RB NUMBER 06-30492
--------------	----------------	-------------------------

4 CODE	5 ITEM	6 QTY.	7 ITEM NAME	8 BRAND / MAKE MANUFACTURER	9 MODEL NAME OR NUMBER	10 MISC. DESCRIPTION	11 IDENTIFICATION / SERIAL NUMBER	12 VALUE
--------	--------	--------	-------------	-----------------------------	------------------------	----------------------	-----------------------------------	----------

I recorded the conversation with [REDACTED] using a digital audio recording device, and I later preserved a copy of the recording on a compact disc. For additional details, refer to the digital audio recording.

13 DATE / TIME OF REPORT 12/20/06/ 3:36 PM	14 REPORTING OFFICER / ID NO / DIV / UNIT Sgt. W. Ayub/#3318/Special Services BA	15 APPROVED BY / ID NO <i>G. [Signature]</i> #991758
---	---	---

CALIFORNIA DEPARTMENT OF MOTOR VEHICLES IMAGE

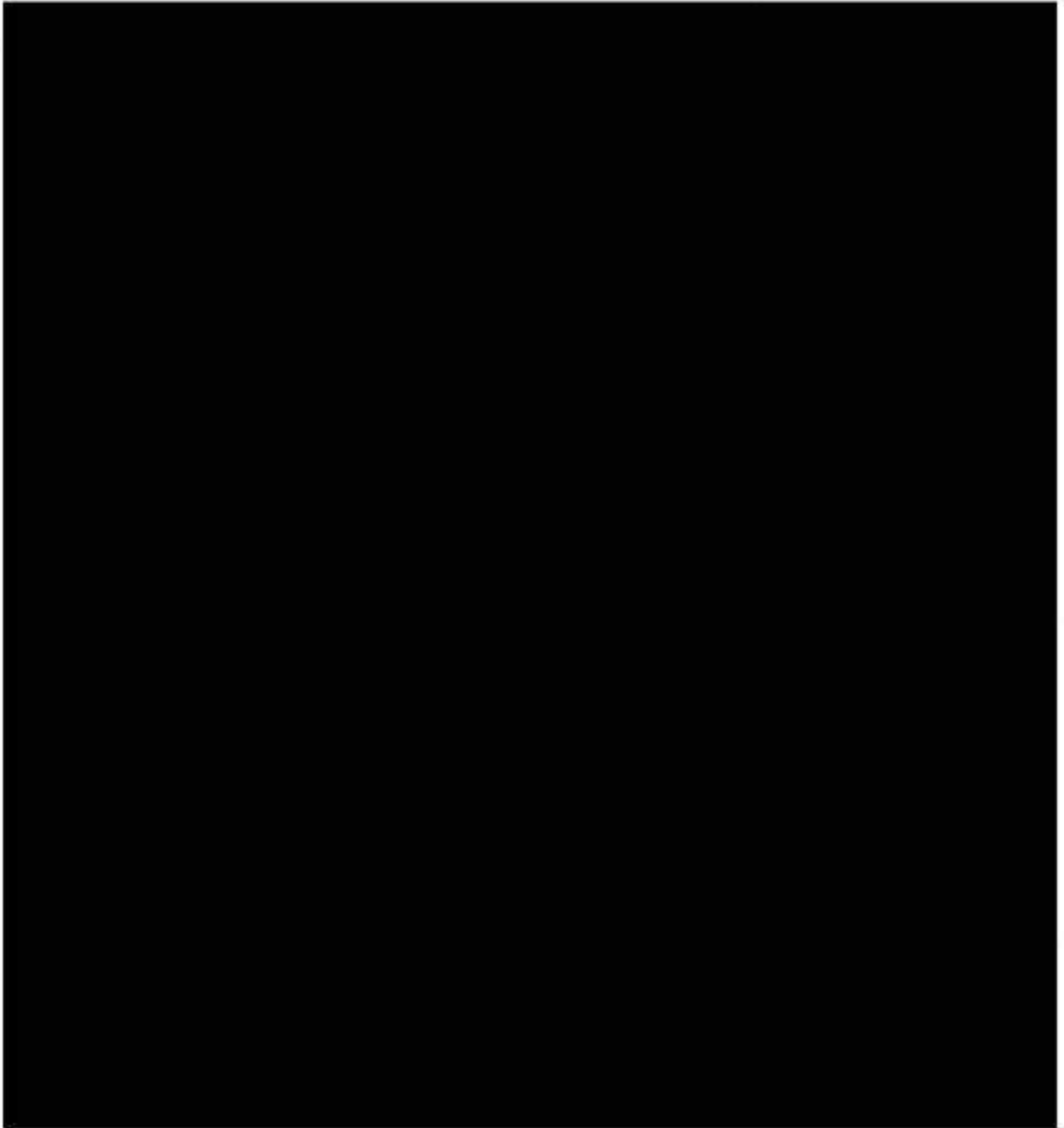

4V1C061HVL0.IN

DATE:12-14-06*TIME:15:14*

MATCHED ON:*L/N*F/N

DMV RECORD FOR LAW ENFORCEMENT USE ONLY

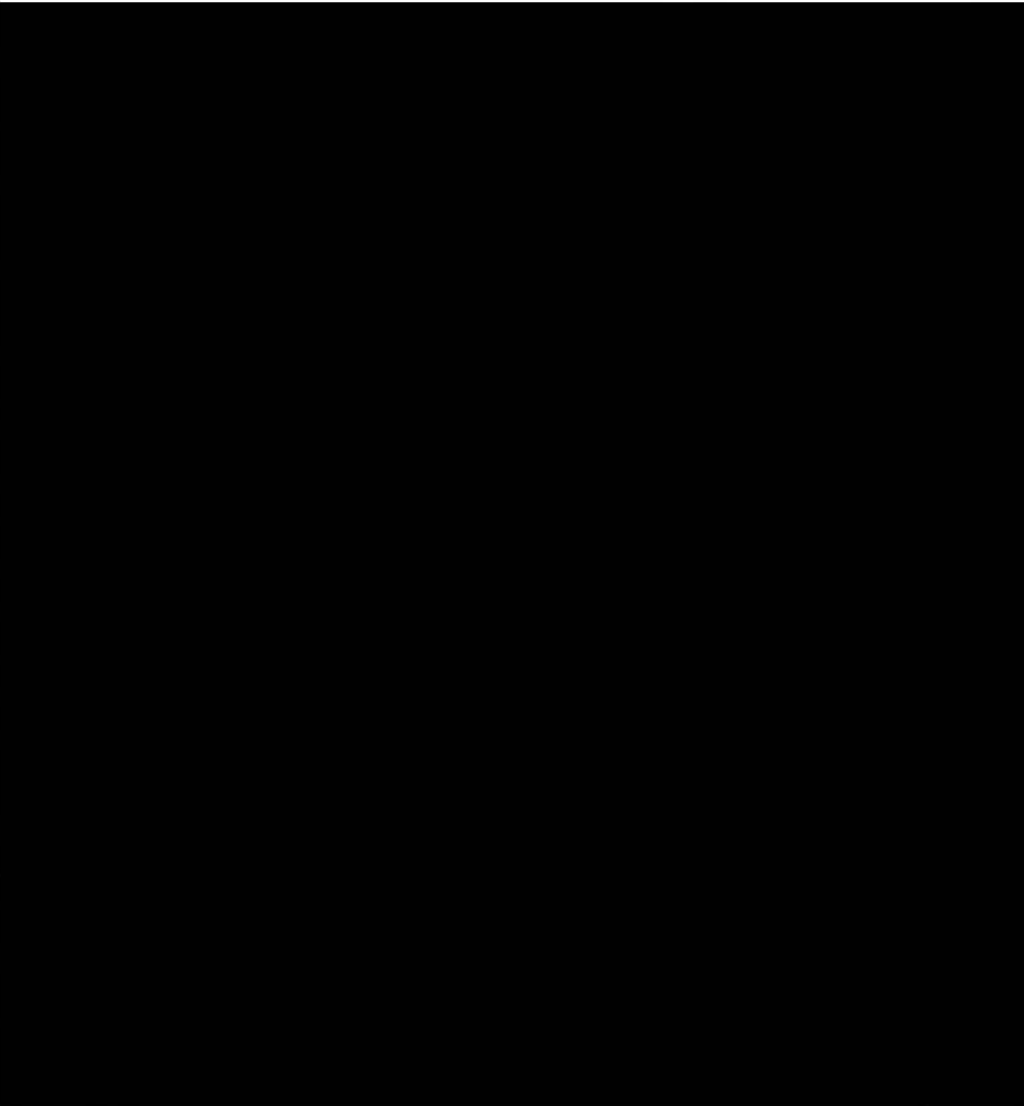

ACCIDENTS:

NONE

END

NARRATIVE REPORT VENTURA COUNTY SHERIFF'S DEPARTMENT

Page 1 of 2 Continuation

AGENCY IDENTIFIER CA0560000

1 RD 9072	2 BEAT 9G01	3 RB NUMBER 06-30492
--------------	----------------	-------------------------

4 CODE	5 ITEM	6 QTY	7 ITEM NAME	8 BRAND / MAKE MANUFACTURER	9 MODEL NAME OR NUMBER	10 MISC. DESCRIPTION	11 IDENTIFICATION / SERIAL NUMBER	12 VALUE
--------	--------	-------	-------------	-----------------------------	------------------------	----------------------	-----------------------------------	----------

Supplemental Case Cleared

Gang Domestic Hate Child Abuse Elderly Abuse

Connecting Report Numbers:

Code Section / Description: Officer Involved Shooting

Reclassify To:

Code: P Name: Canley, Adrian Doyle



On 12/20/06, at about 1740 hours, I spoke over the telephone with Ventura County Sheriff's Deputy Sam Dominguez. I had earlier received information that Deputy Dominguez was a [REDACTED] to Adrian Canley. Canley was involved in an altercation, on the evening of 11/14/06, with Ventura County Sheriff's Detective Shane Matthews, which resulted in Adrian being shot by Detective Matthews. Adrian later died of the injuries he sustained from the shooting.

I asked Deputy Dominguez if he was, in fact, [REDACTED] Adrian Canley. Deputy Dominguez told me that he was, and he explained that Adrian was [REDACTED]. Specifically, Adrian's mother, [REDACTED] Canley, is Deputy Dominguez' [REDACTED]. Deputy Dominguez identified his [REDACTED] as [REDACTED] [REDACTED], and he confirmed that [REDACTED] lives on [REDACTED].

Deputy Dominguez told me he has known Adrian's family for approximately 13 years. He did not know Adrian well, but he knew Adrian grew up in the West Hills area of Los Angeles. He described Adrian as having a good upbringing, and he recalled visiting Adrian's immediate family when Adrian was a young child.

13 DATE / TIME OF REPORT 12/22/06/ 1:34 PM	14 REPORTING OFFICER / ID NO / DIV / UNIT Sgt. W. Ayub/#3318/Special Services	APPROVED BY / ID NO <i>[Signature]</i> #11759
---	--	--

NARRATIVE REPORT VENTURA COUNTY SHERIFF'S DEPARTMENT

Page 2 of 2 Continuation

AGENCY IDENTIFIER CA0560000

1 RD 9072	2 BEAT 9G01	3 RB NUMBER 06-30492
--------------	----------------	-------------------------

4 CODE	5 ITEM	6 QTY.	7 ITEM NAME	8 BRAND / MAKE MANUFACTURER	9 MODEL NAME OR NUMBER	10 MISC. DESCRIPTION	11 IDENTIFICATION / SERIAL NUMBER	12 VALUE
--------	--------	--------	-------------	-----------------------------	------------------------	----------------------	-----------------------------------	----------

Deputy Dominguez told me he had not seen Adrian in approximately 1 year. However, he spoke with [REDACTED] about Adrian, and she told him that Adrian and [REDACTED] had been living with her for a short period of time prior to the shooting. According to [REDACTED] Adrian had been acting very paranoid, during the time they lived together. Based on [REDACTED]'s description of Adrian's behavior, Deputy Dominguez suspected that Adrian might have been abusing illicit drugs.

Deputy Dominguez told me that [REDACTED] came to stay at [REDACTED] out of fear that Adrain was going to harm her. He elaborated and explained that Adrian became involved in a physical fight with a neighbor while he and [REDACTED] lived with her on Rexford Street. After the fight, [REDACTED] and Adrian moved to another relative's residence in Santa Paula. On the day [REDACTED] came to [REDACTED] Deputy Dominguez, [REDACTED] spoke to [REDACTED] who told [REDACTED] that Adrian was possibly on his way to [REDACTED]'s residence in Ventura to cause trouble, and Adrian was armed with a handgun. Out of concern for her safety, [REDACTED] came to Deputy Dominguez' [REDACTED] for shelter.

Deputy Dominguez said he did not know any of the specific details of the shooting, and he confirmed he has spoken with other members of the Sheriff's Department and his family about it. He also confirmed that he attended Adrian's funeral services.

13 DATE / TIME OF REPORT
12/22/06/ 1:34 PM

14 REPORTING OFFICER / ID NO / DIV / UNIT
Sgt. W. Ayub/#3318/Special Services BA

15 APPROVED BY / ID NO
[Signature] #917305



Ventura County Sheriff's Department

Background Packet

RB#: 06-30492

Requested by Sgt. Bill Ayub

Date Requested 11/15/2006

Date Needed 11/15/2006

Last Name: **Canley**

First Name: **Adrian**

Middle Name: **Doyle**

Suffix:

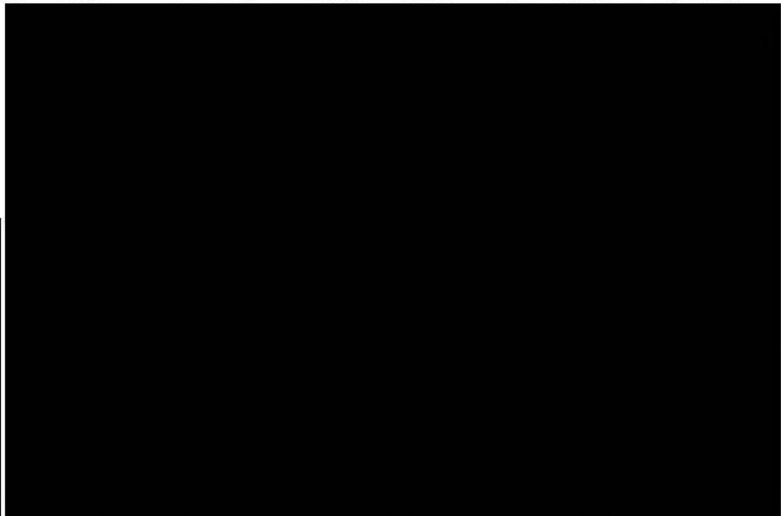
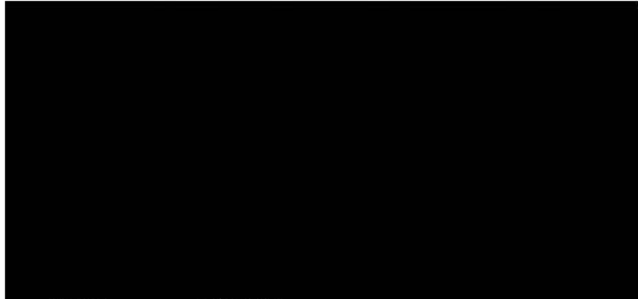

Eyes: Brown

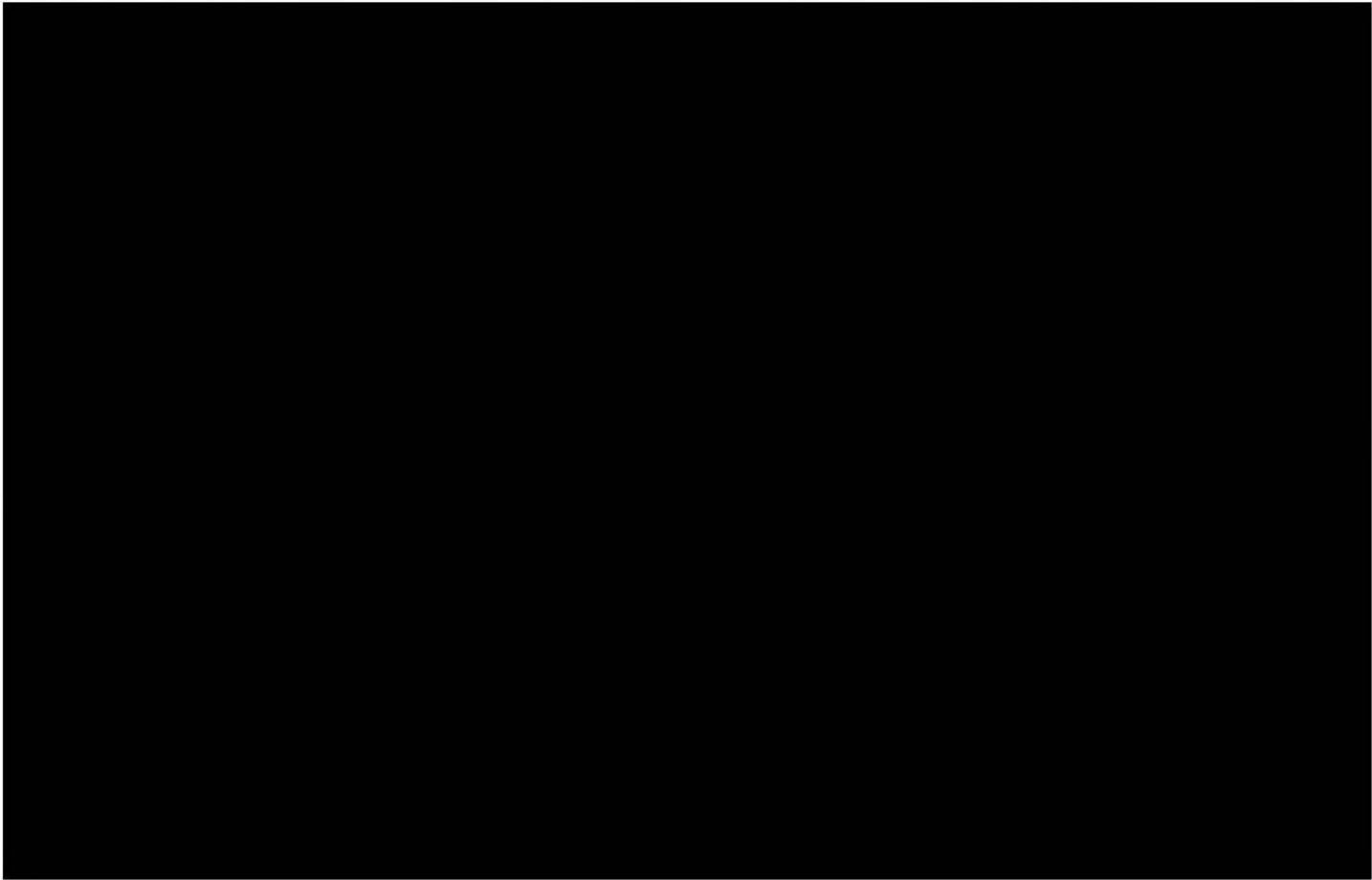



Ventura County Sheriff's Department
Background Packet

RB#: 06-30492
Requested by Sgt. Bill Ayub
Date Requested 11/15/2006
Date Needed 11/15/2006

DMV:

***** County of Ventura Clets Interface System ***** 11/15/2006 12:09:24

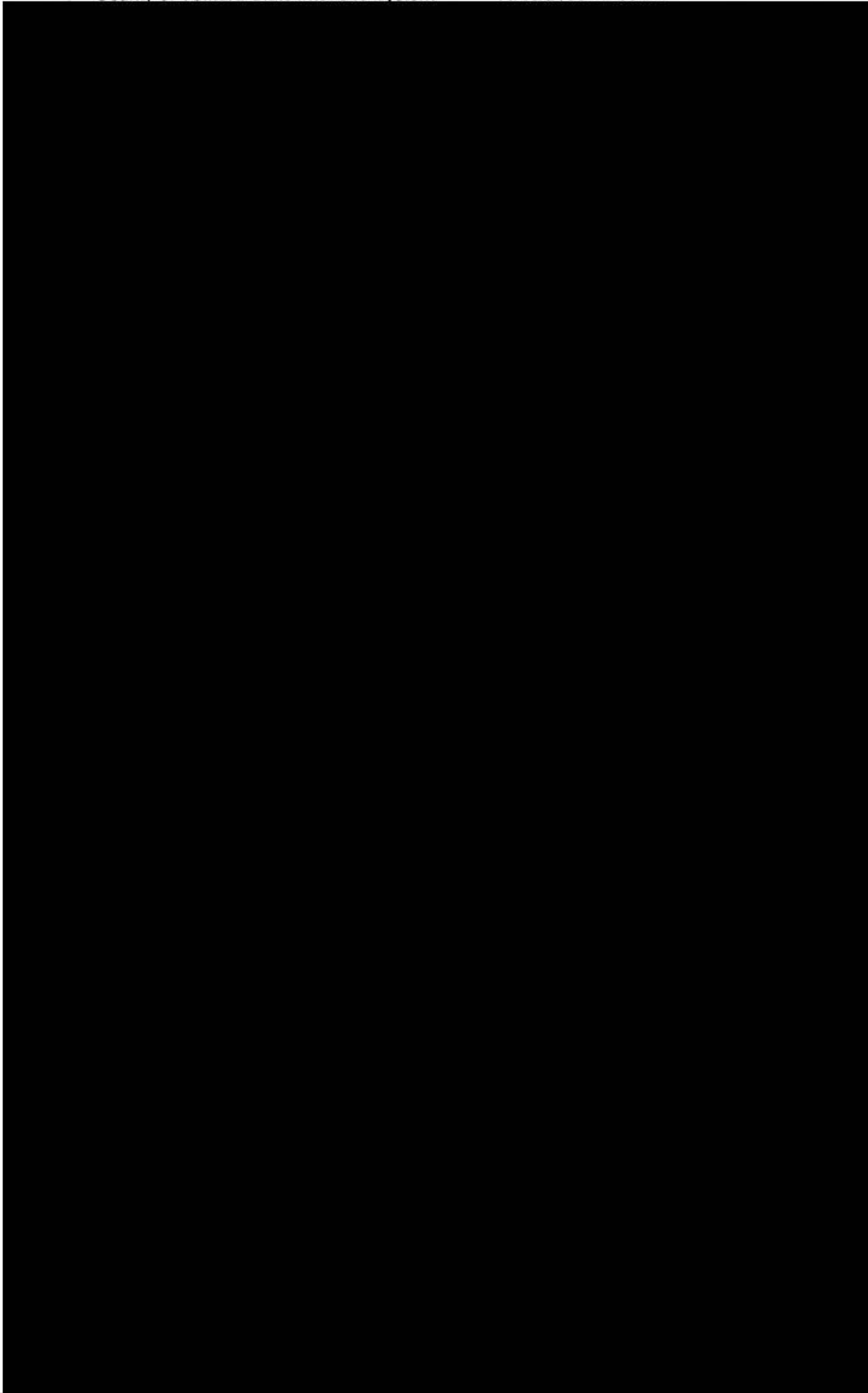



Ventura County Sheriff's Department
Background Packet

RB# 06-30492
Requested by Sgt. Bill Ayub
Date Requested 11/15/2006
Date Needed 11/15/2006



END



Ventura County Sheriff's Department

Background Packet

RB#: 06-30492

Requested by Sgt. Bill Ayub

Date Requested 11/15/2006

Date Needed 11/15/2006

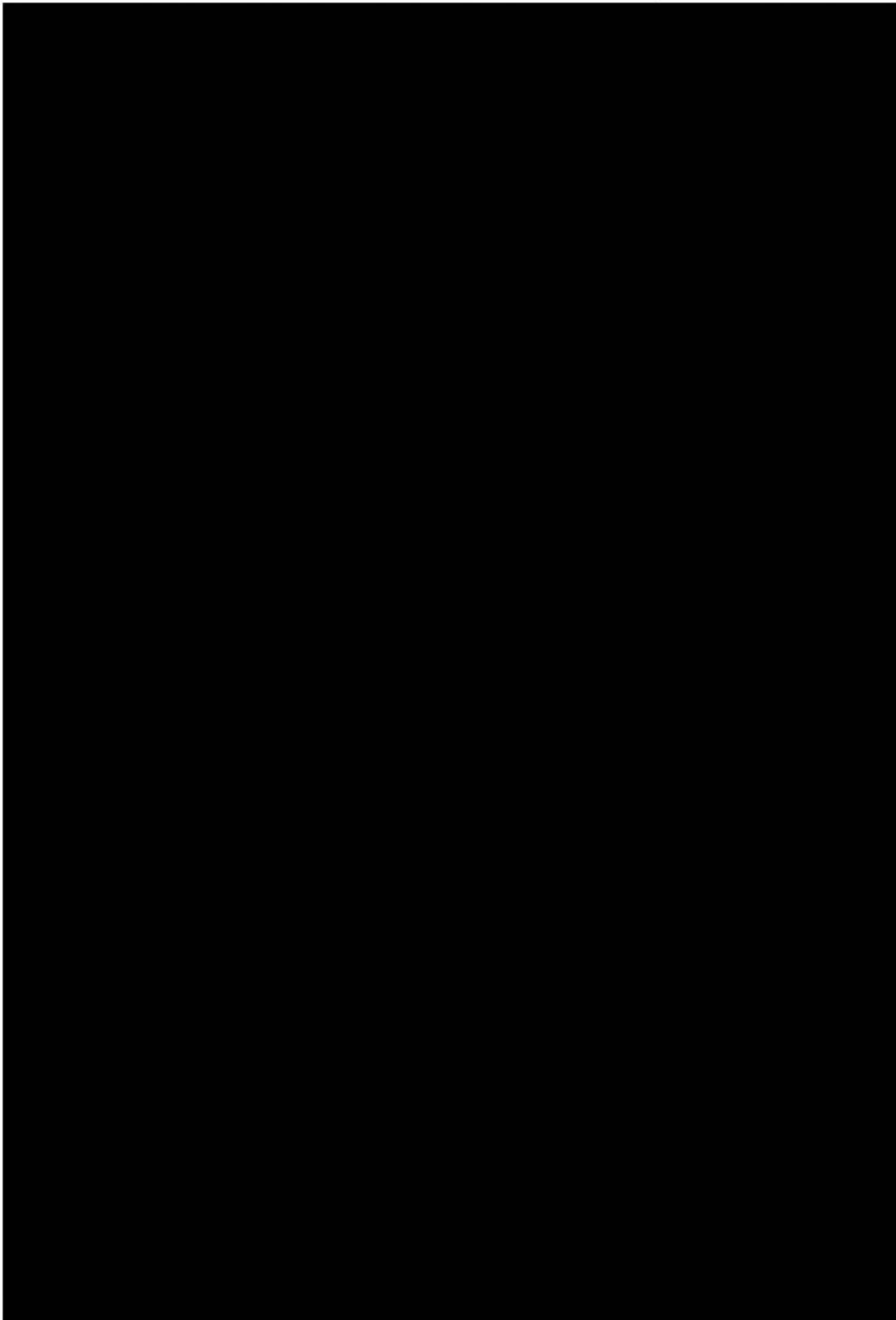



Ventura County Sheriff's Department
Background Packet

RR# 06-30492
Requested by Sgt. Bill Ayub
Date Requested 11/15/2006
Date Needed 11/15/2006

....





Ventura County Sheriff's Department

Background Packet

RB#: 06-30492

Requested by Sgt. Bill Ayub

Date Requested 11/15/2006

Date Needed 11/15/2006

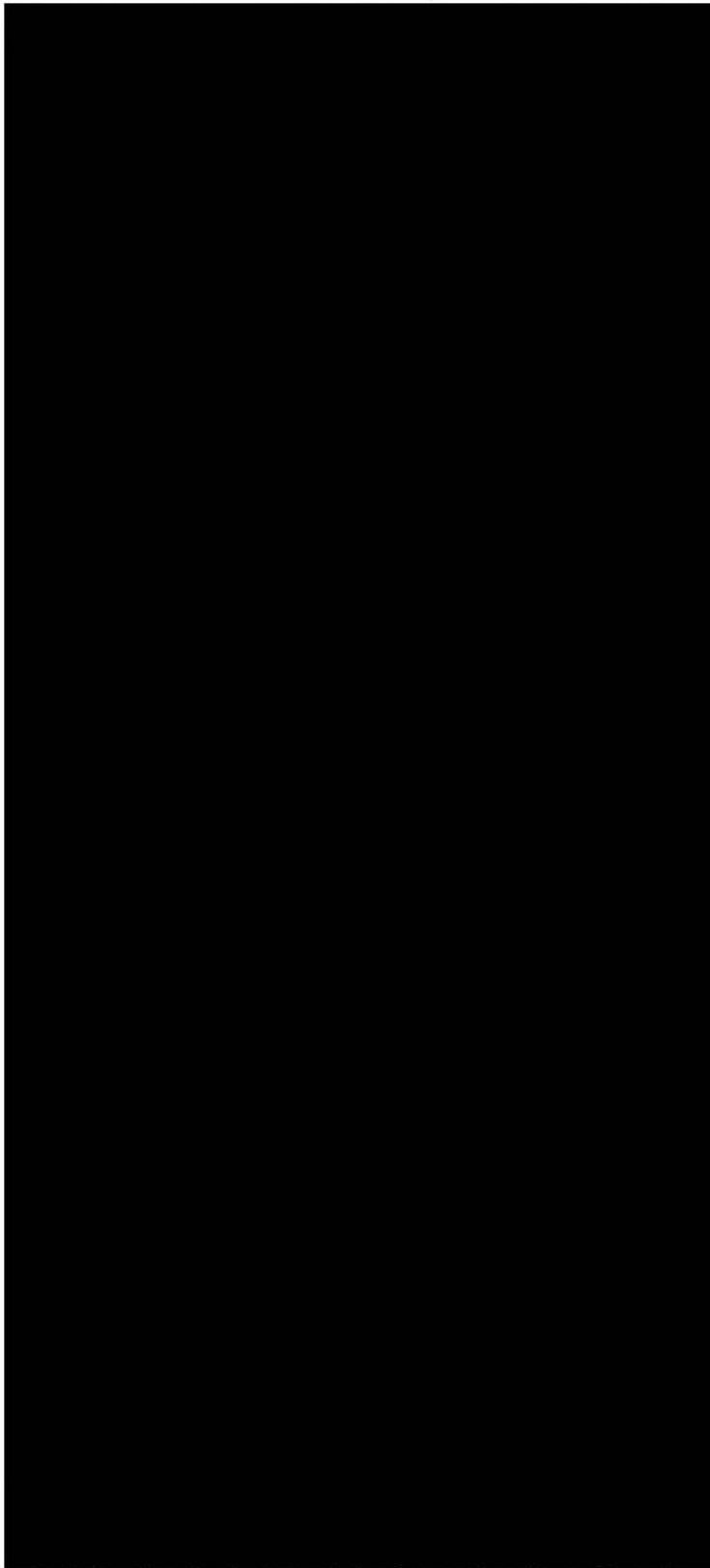



Ventura County Sheriff's Department

Background Packet

RB#: 06-30492

Requested by Sgt. Bill Ayub

Date Requested 11/15/2006

Date Needed 11/15/2006



DepartmentName

CANLEY, ADRIAN DOYLE

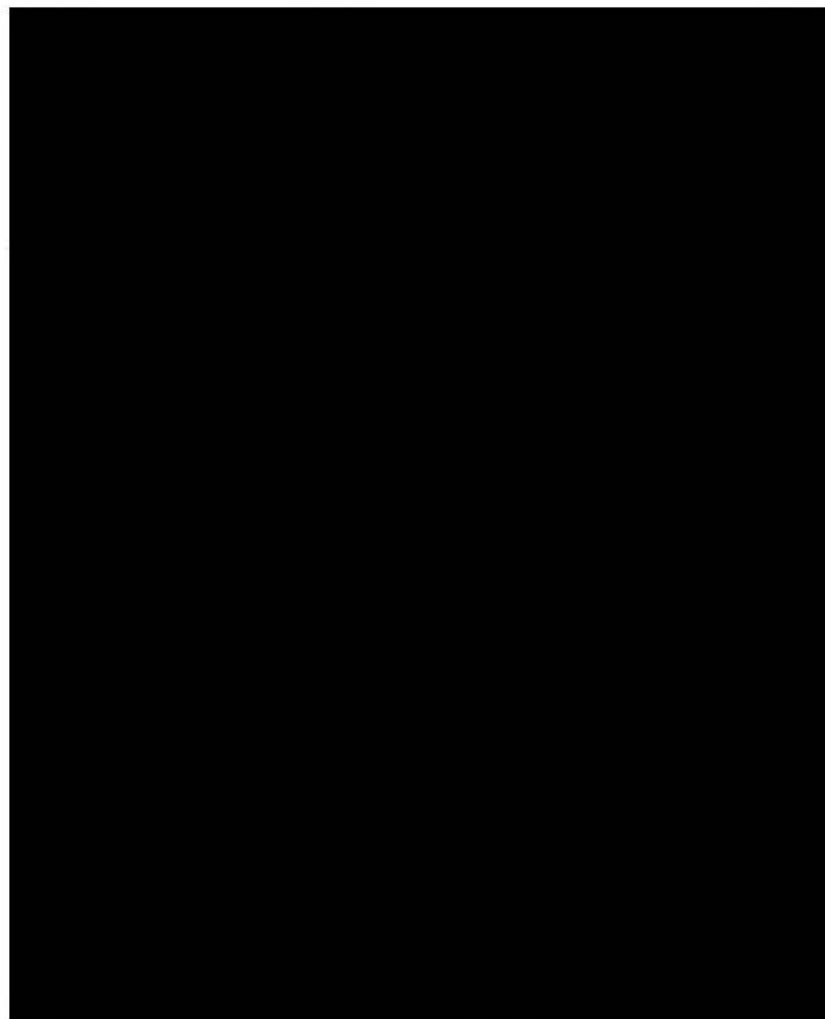
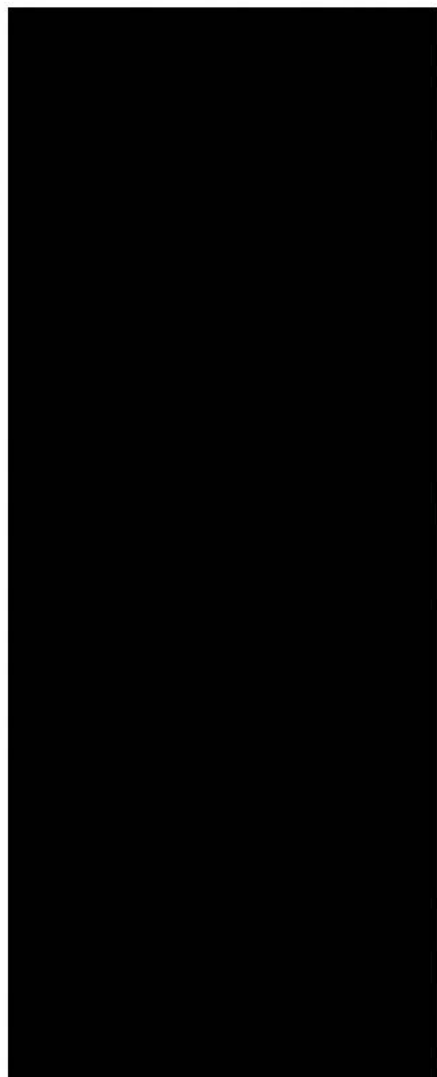

DepartmentName

CANLEY, ADRIAN DOYLE

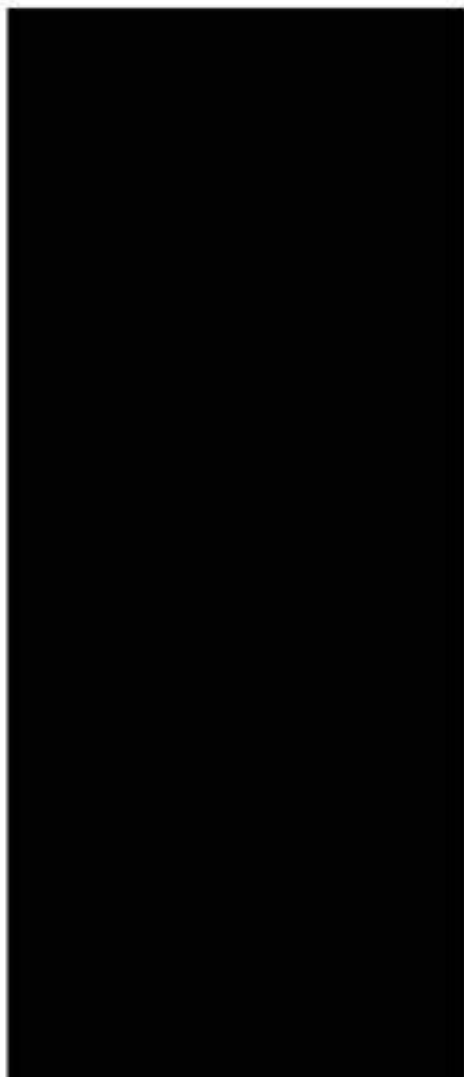

DepartmentName

CANLEY, ADRIAN DOYLE

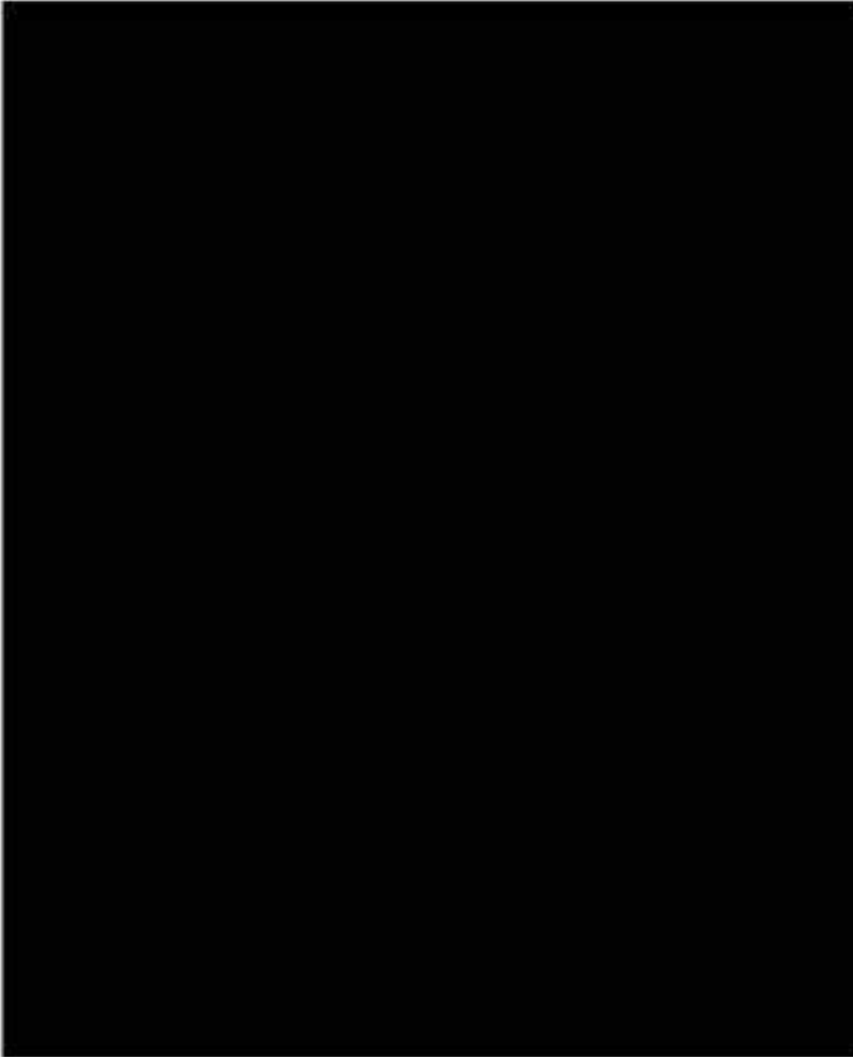
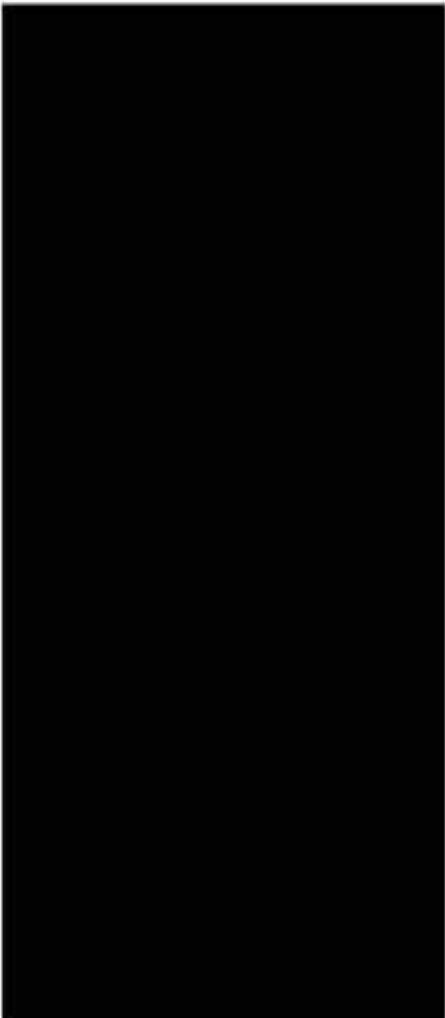



Ventura County Sheriff's Department
Background Packet

RB#: 06-30492
Requested by Sgt. Bill Ayub
Date Requested 11/15/2006
Date Needed 11/15/2006

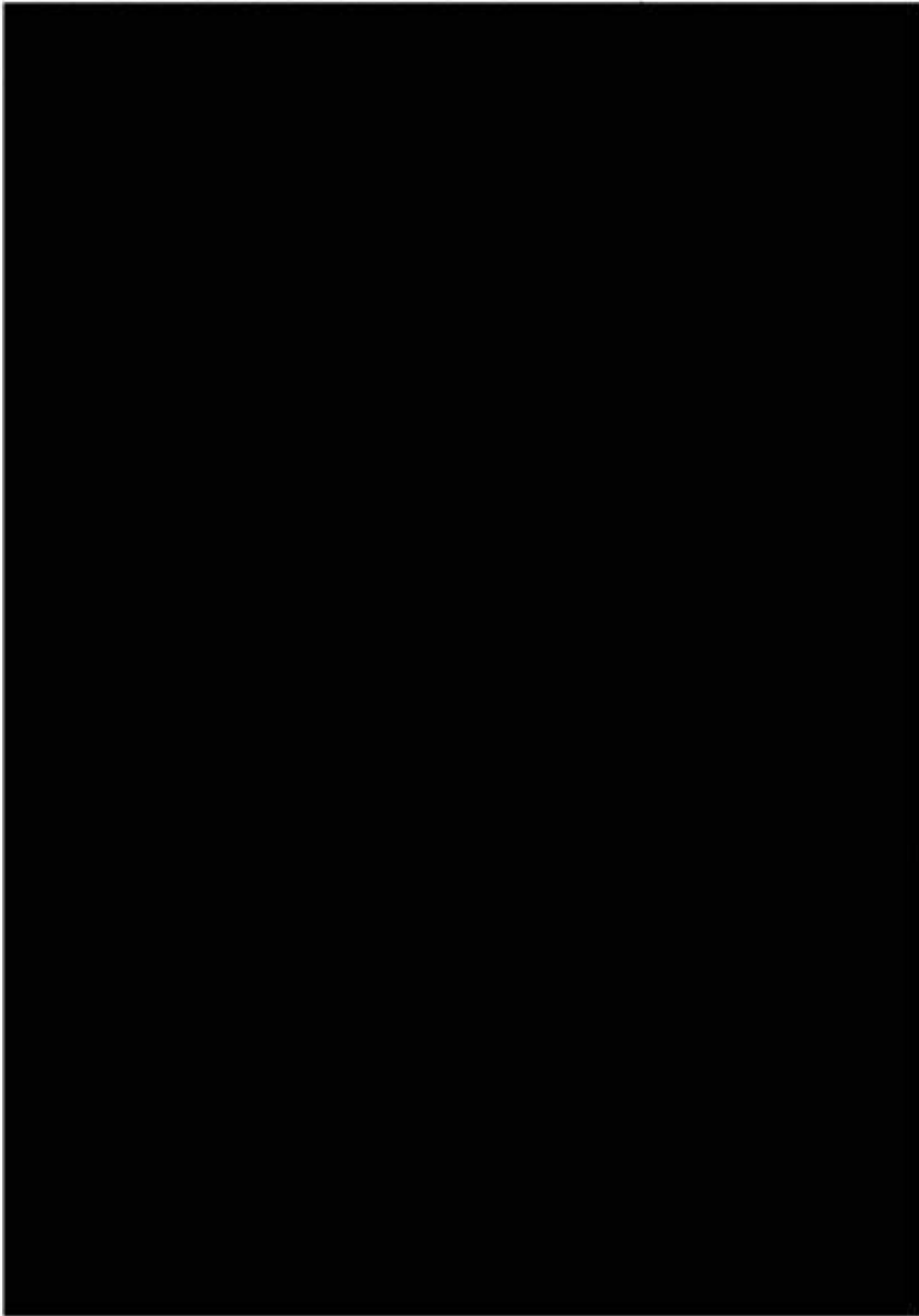



Ventura County Sheriff's Department

Background Packet

RB#: 06-30492

Requested by Sgt. Bill Ayub

Date Requested 11/15/2006

Date Needed 11/15/2006

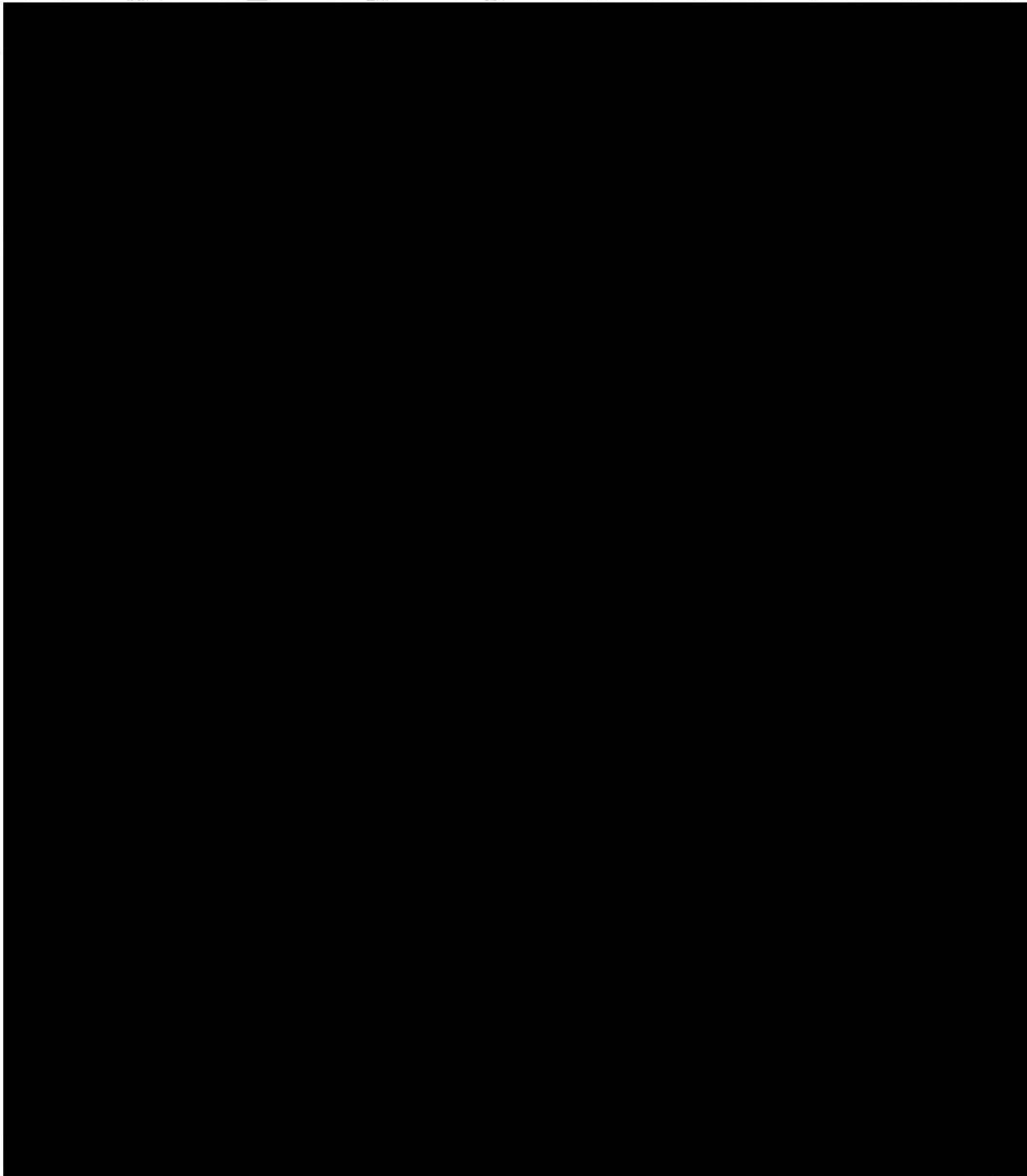



Ventura County Sheriff's Department
Background Packet

RB#: 06-30492
Requested by Sgt. Bill Ayub
Date Requested 11/15/2006
Date Needed 11/15/2006

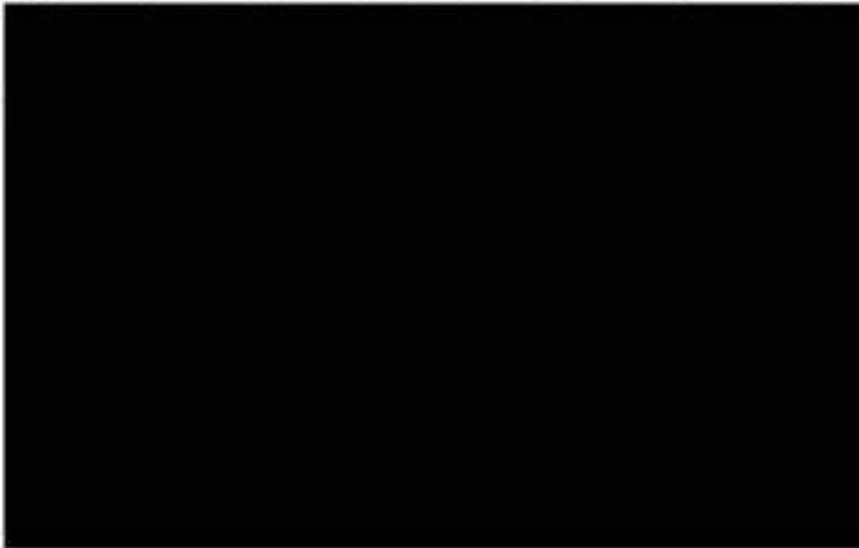

END



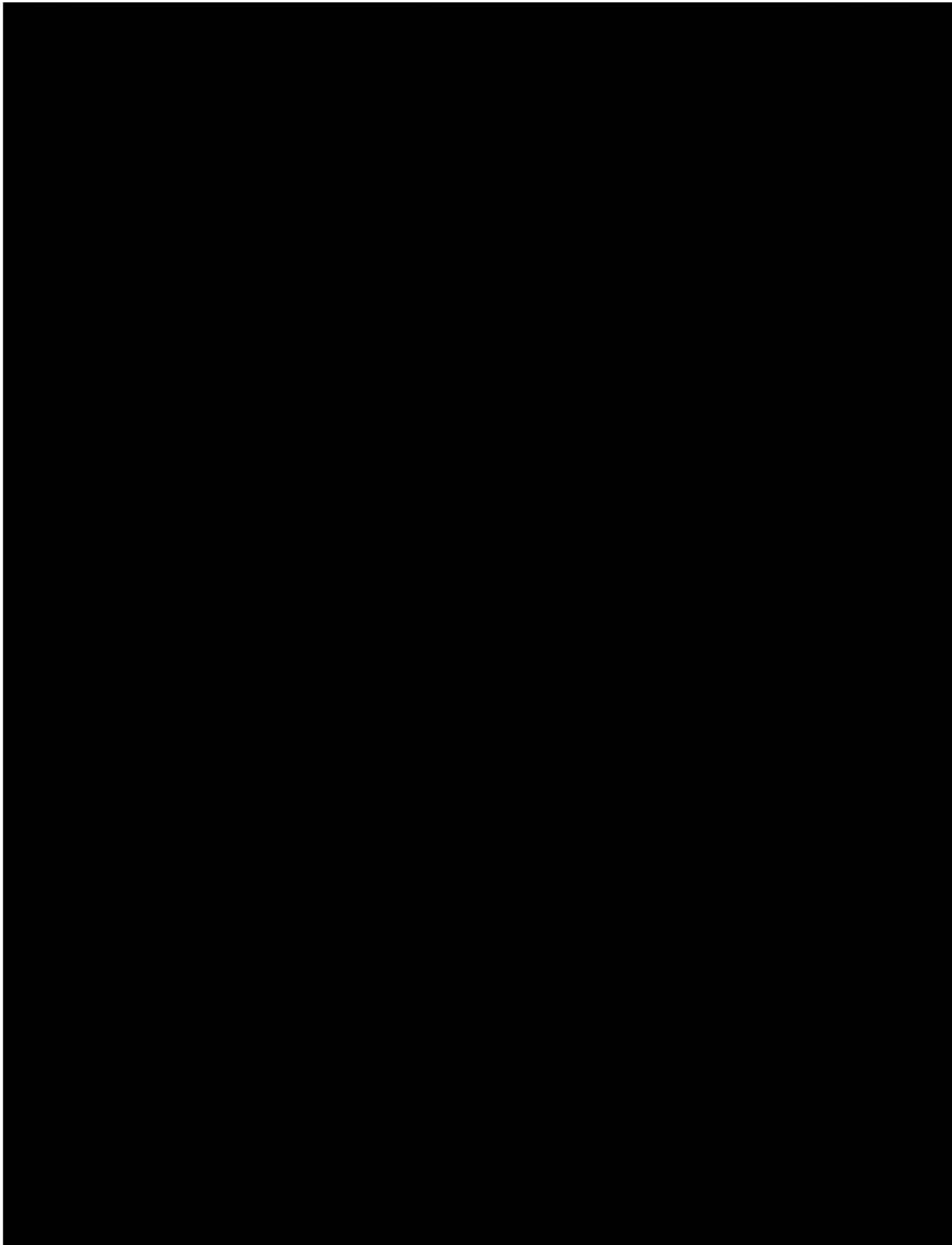

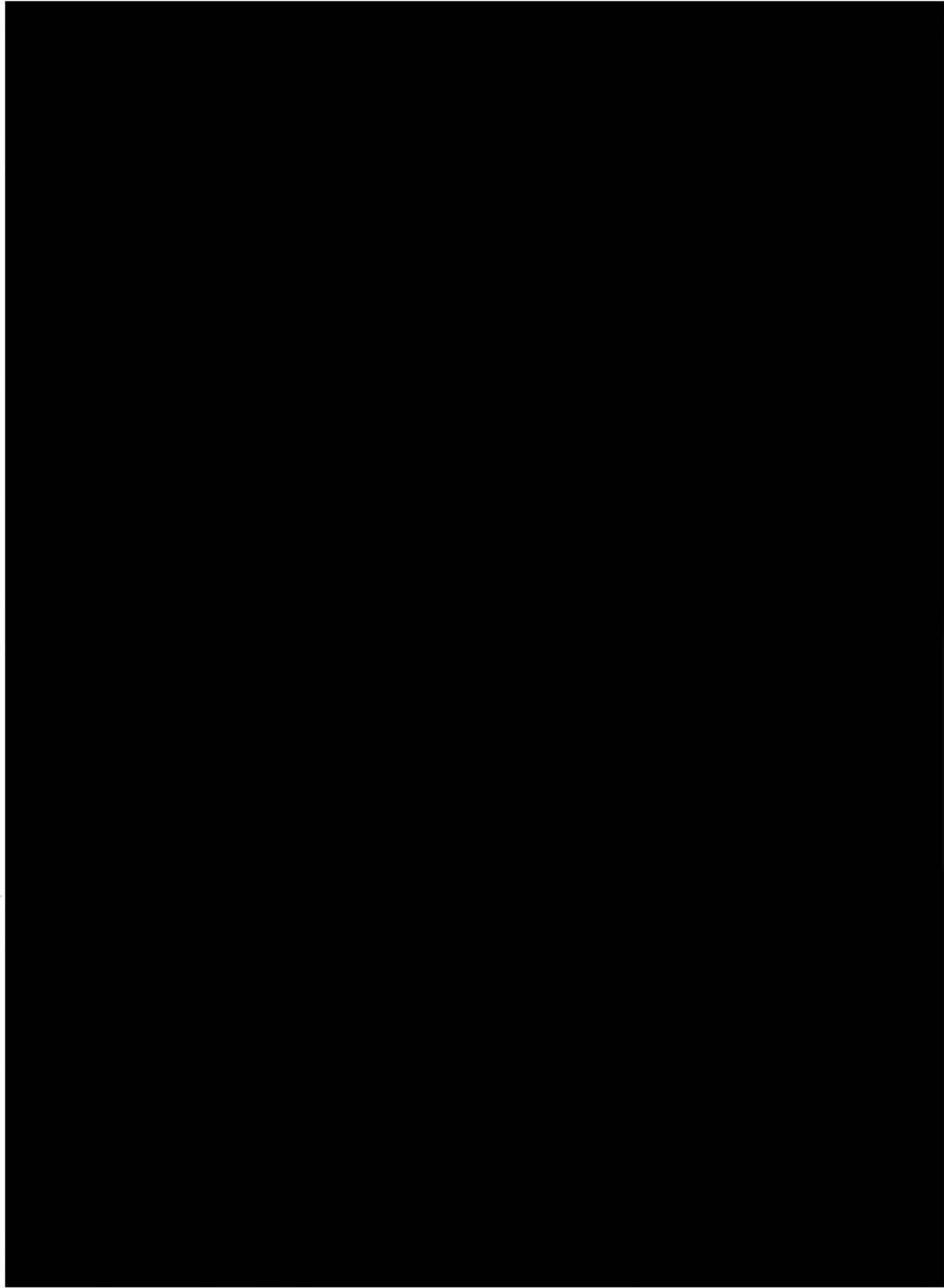

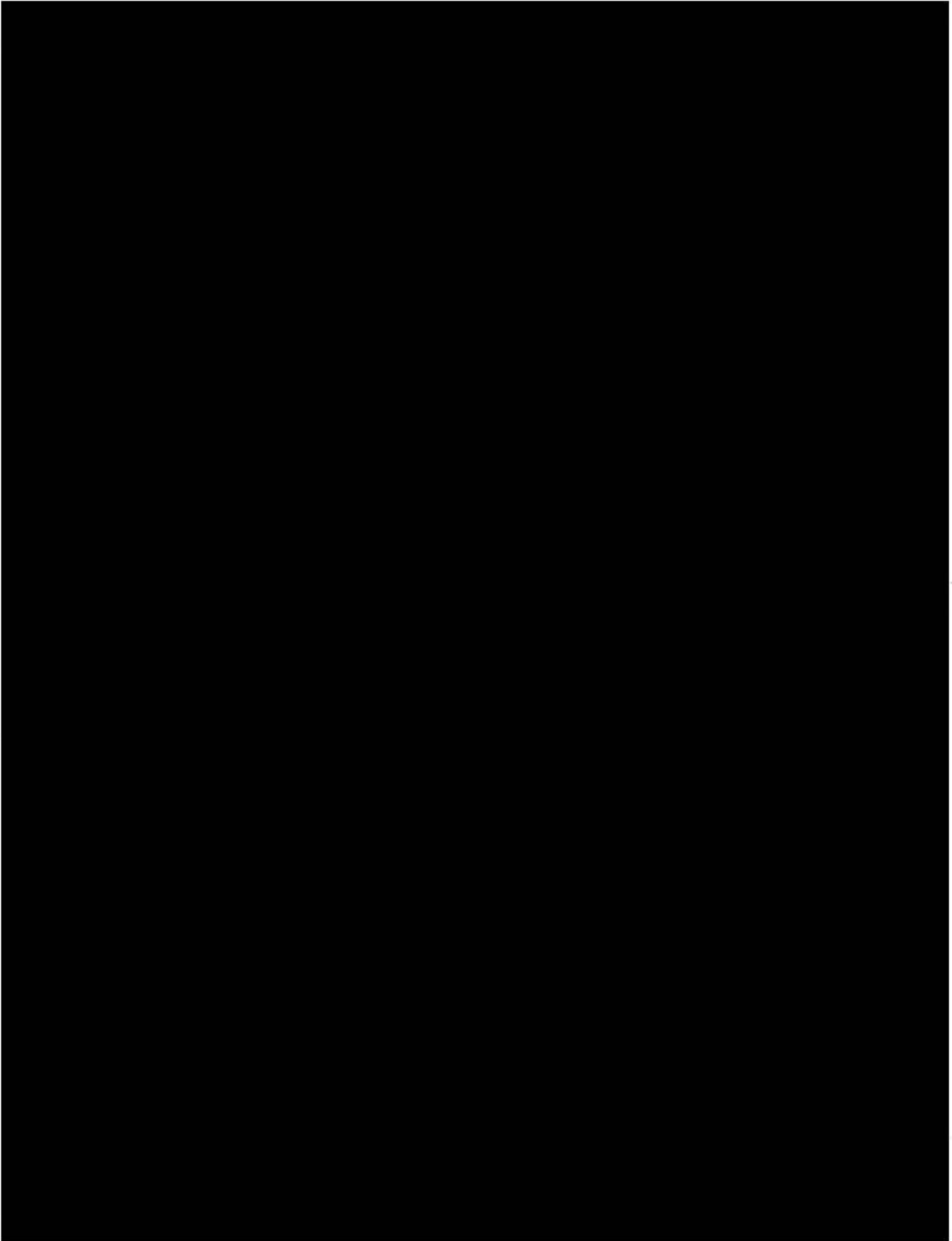

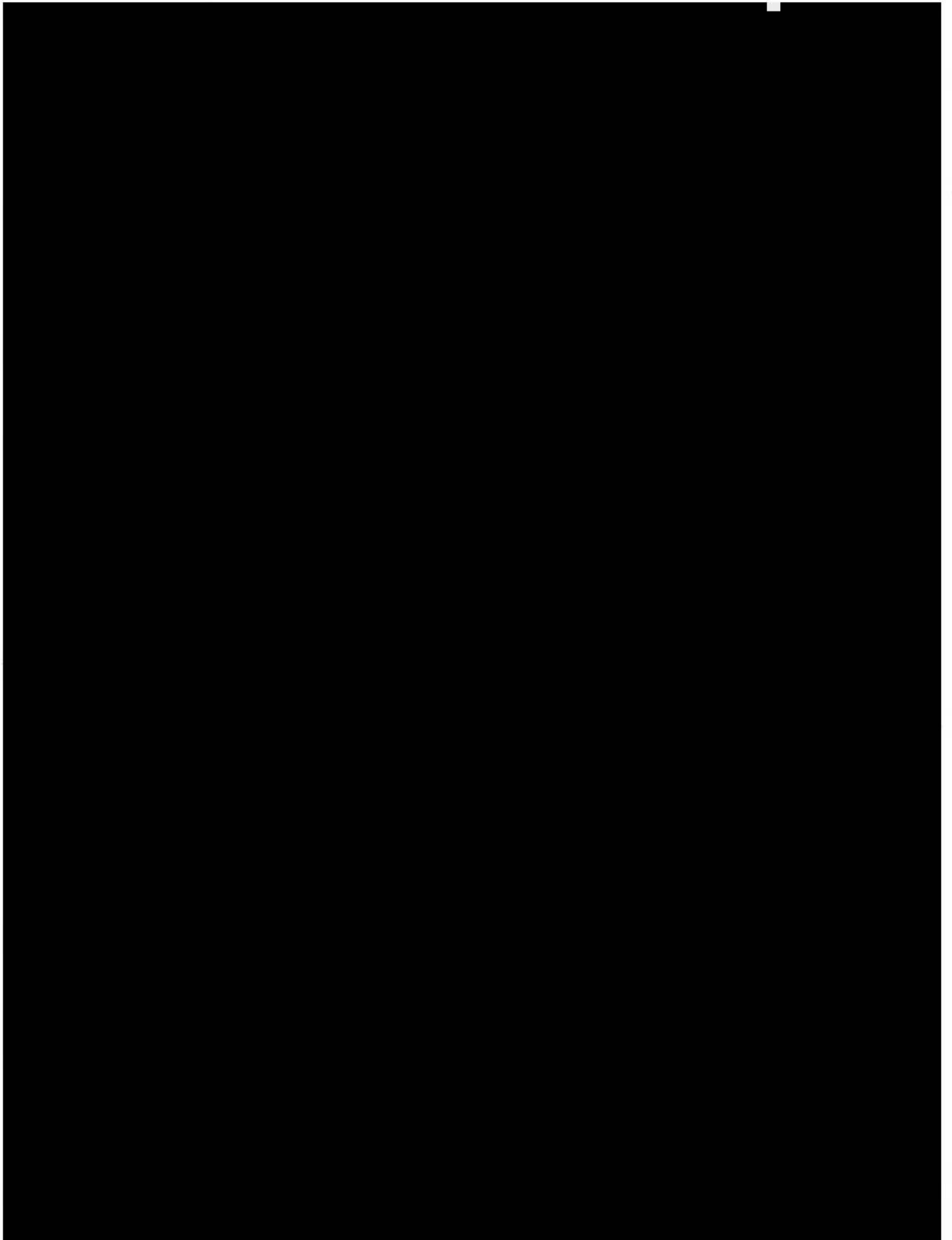

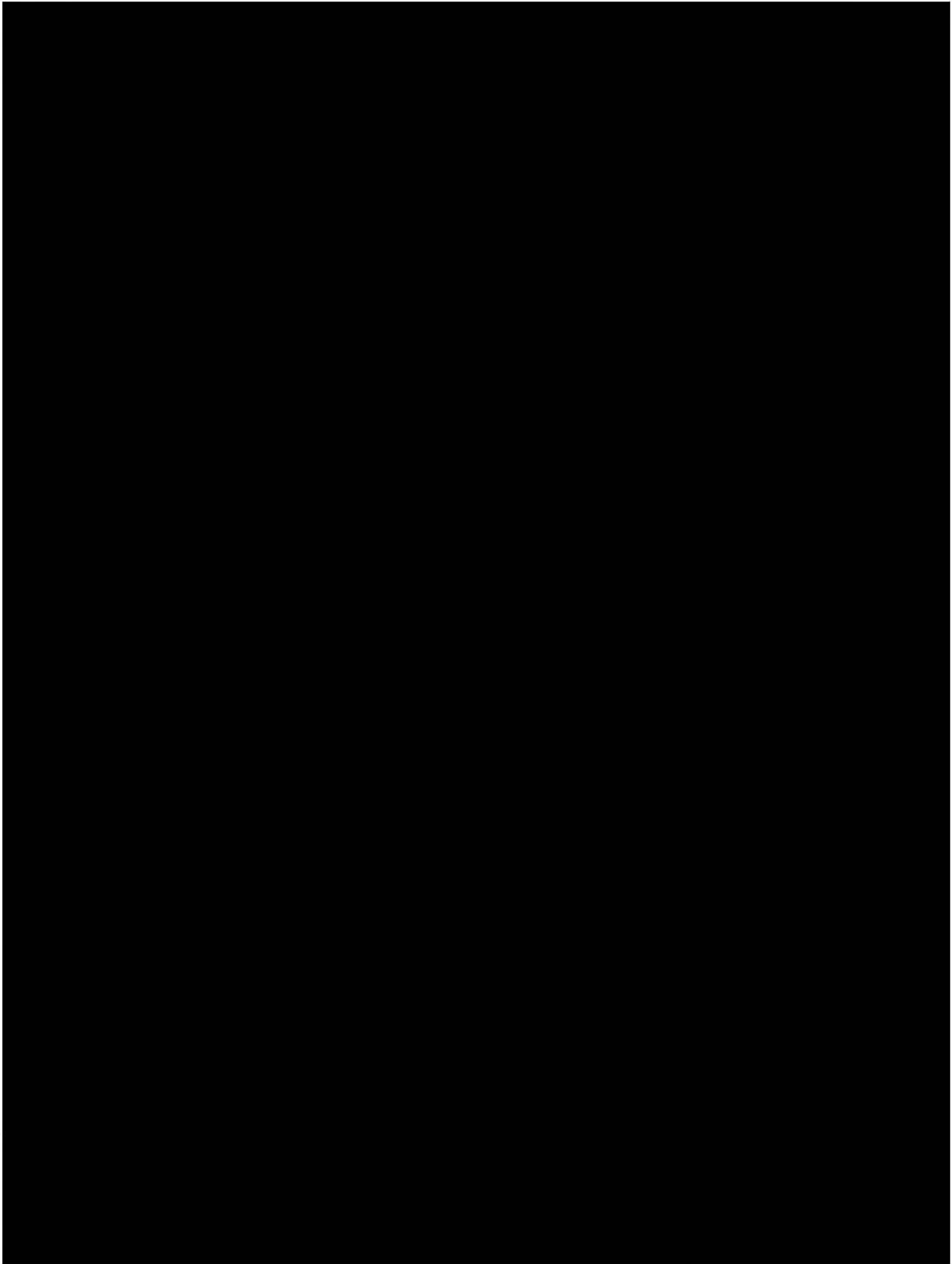

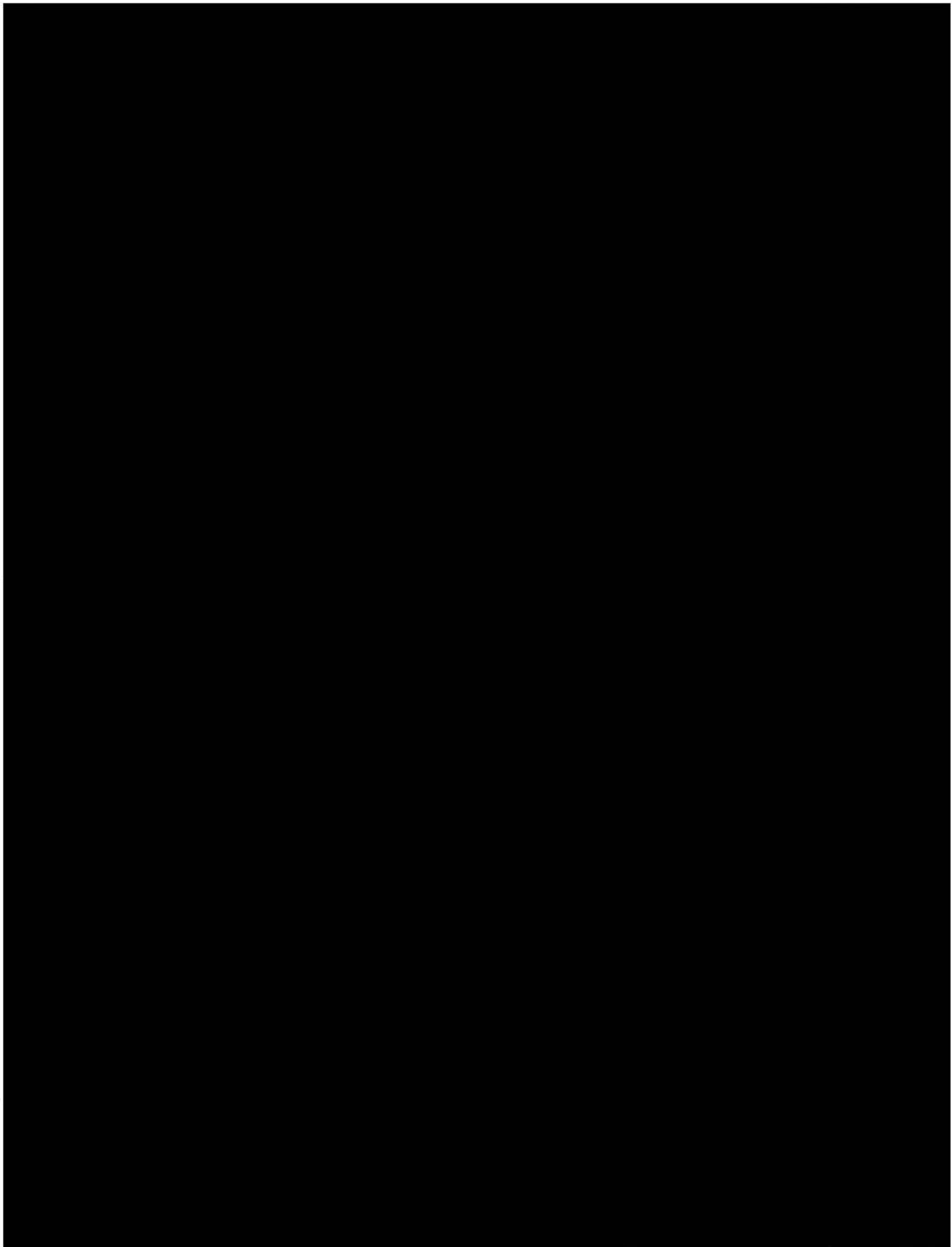

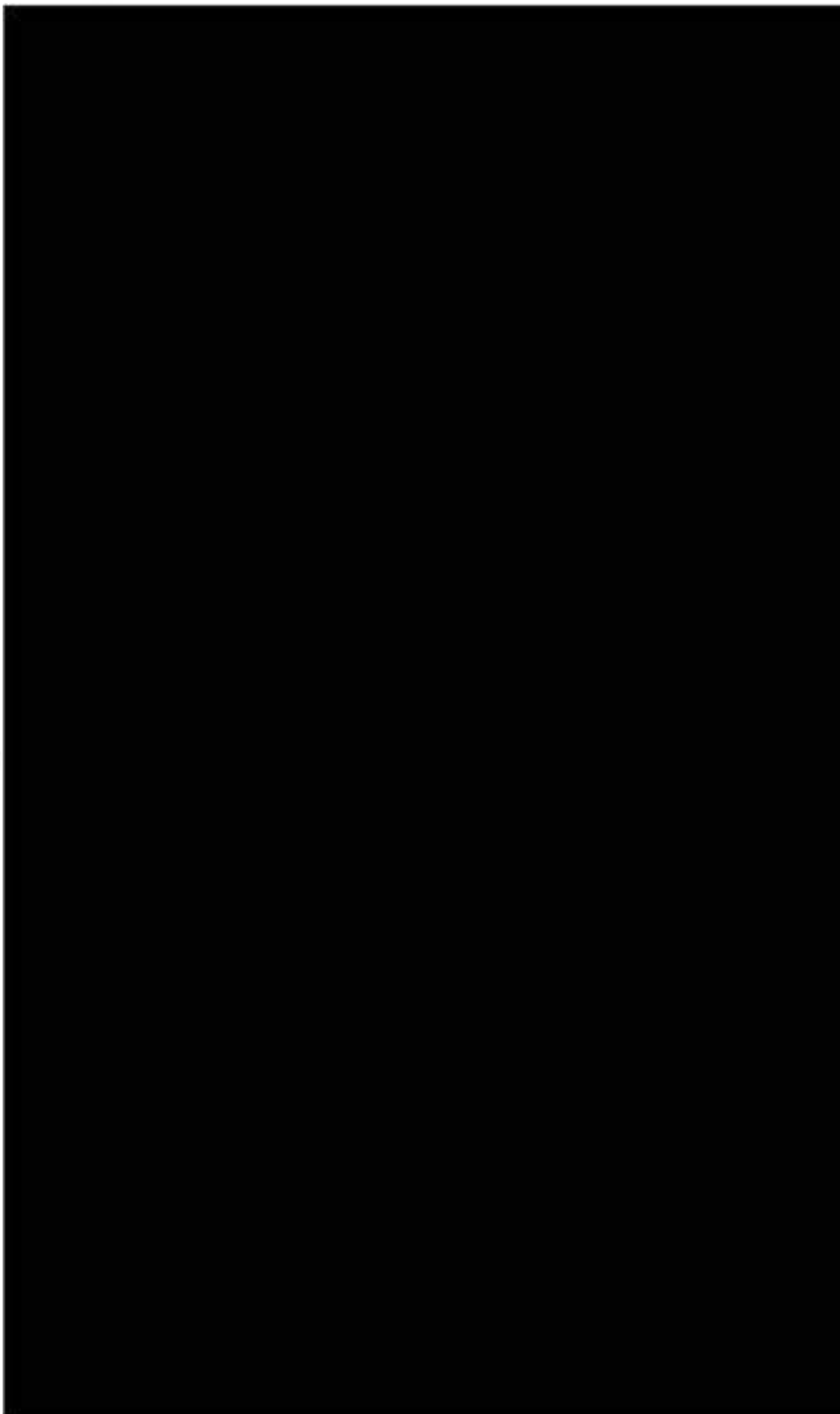



ENTERSECT Police Online *Enhancing Your Intelligence Services*

[Home](#) [Contact Us](#) [Logout](#)

For Printer Friendly Version Click 

[Person Search](#) [Property Search](#) [Vehicle Search](#) [Civil Search](#) [Corporation Search](#)

Available reports:

Basic

Enhanced

Driver_License Phones Relatives Civil_Actions Court Vessels Properties Deeds Relationships Vehicles Corporations

ADRIAN CANLEY



Database was searched but no data was found.

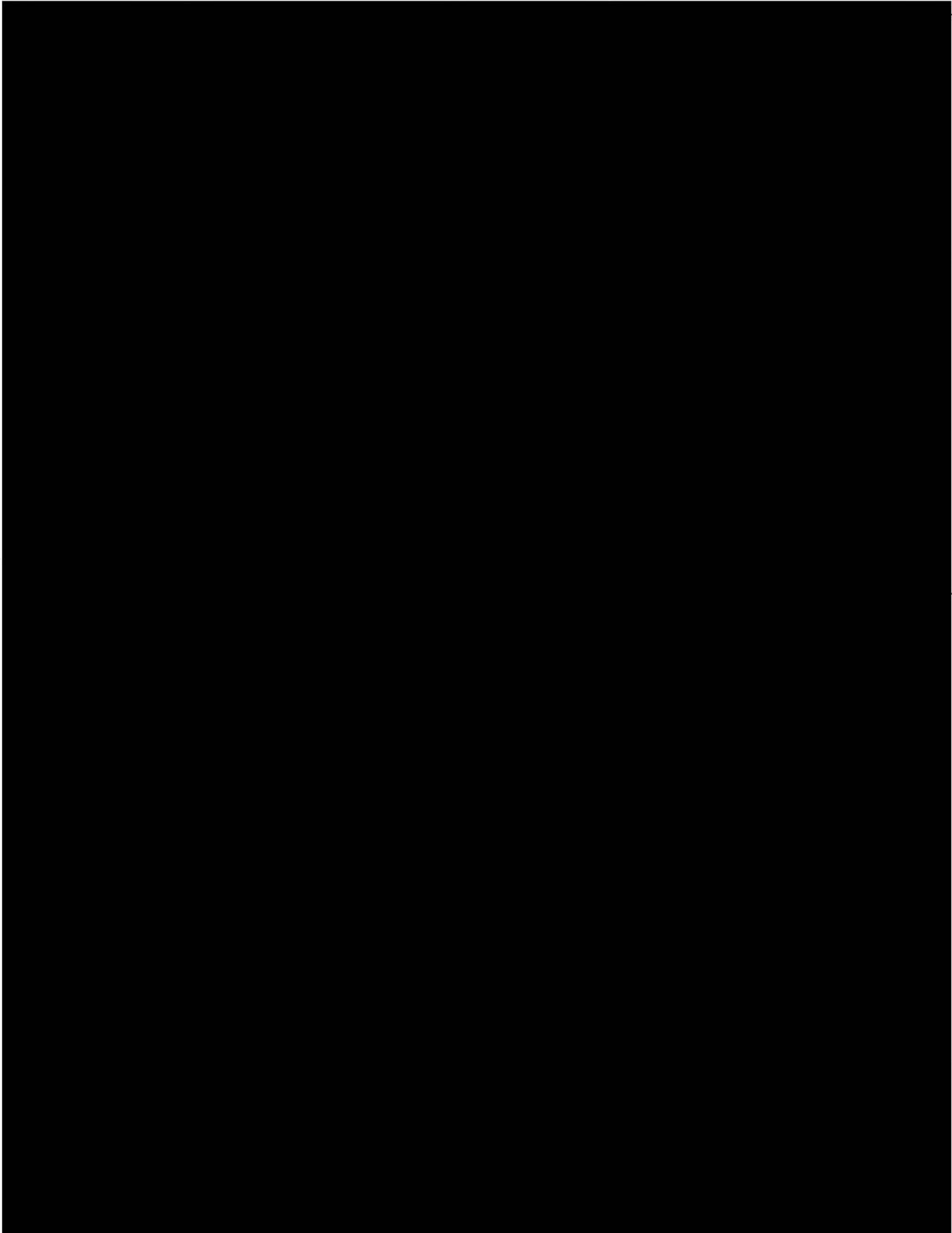

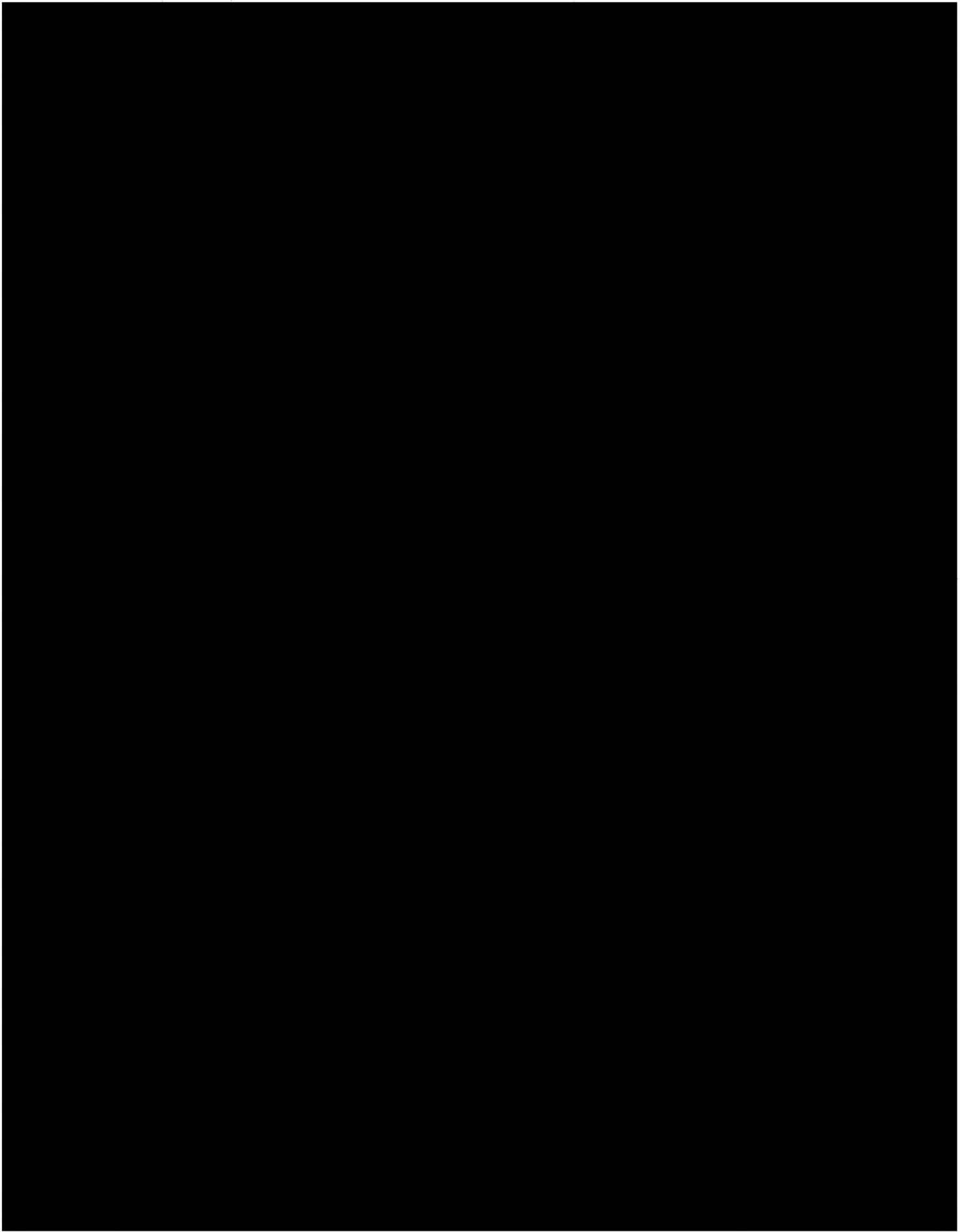

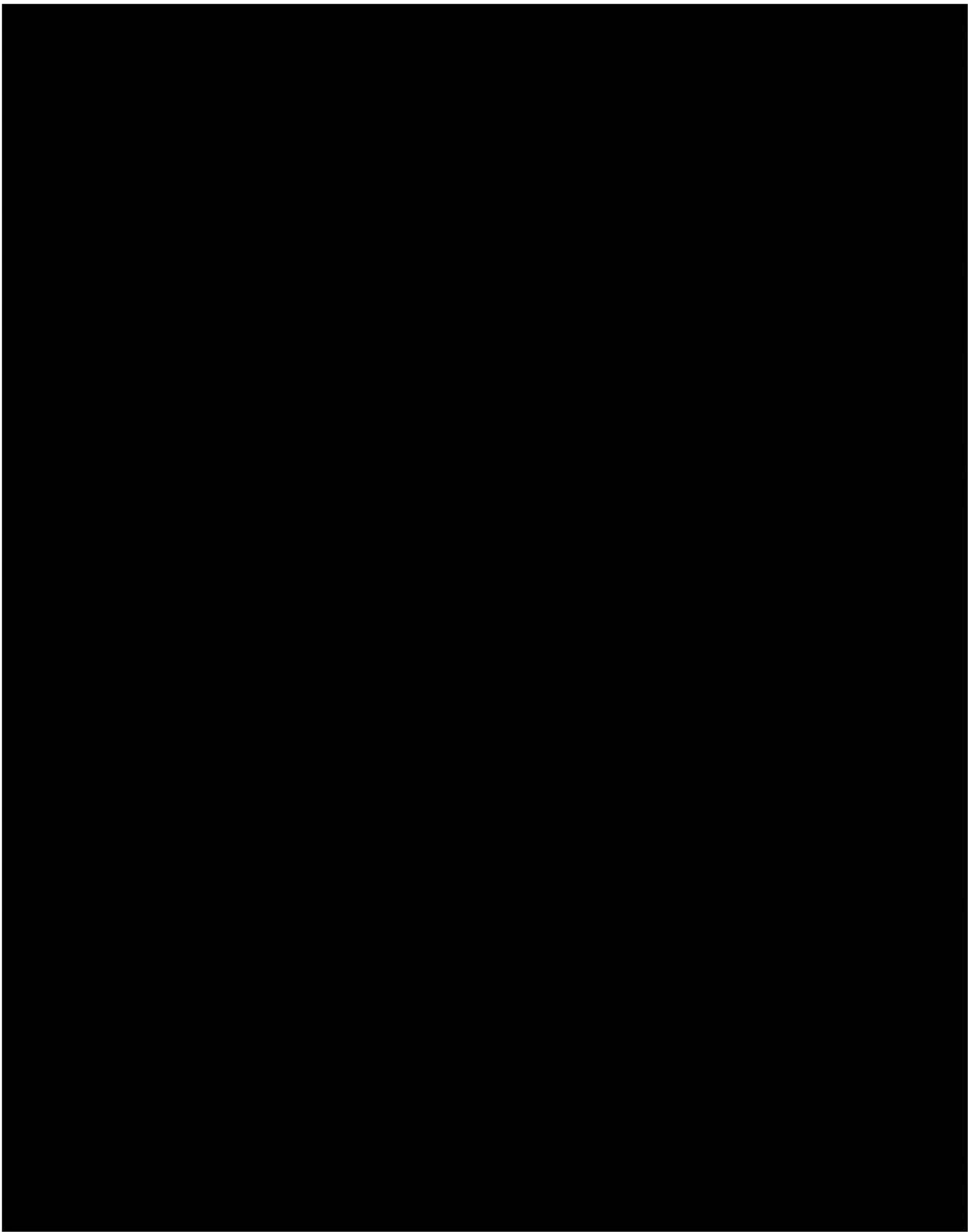

Database was searched but no data was found.



**CALIFORNIA DEPARTMENT OF MOTOR VEHICLES IMAGE
ADRIAN DOYLE CANLEY**



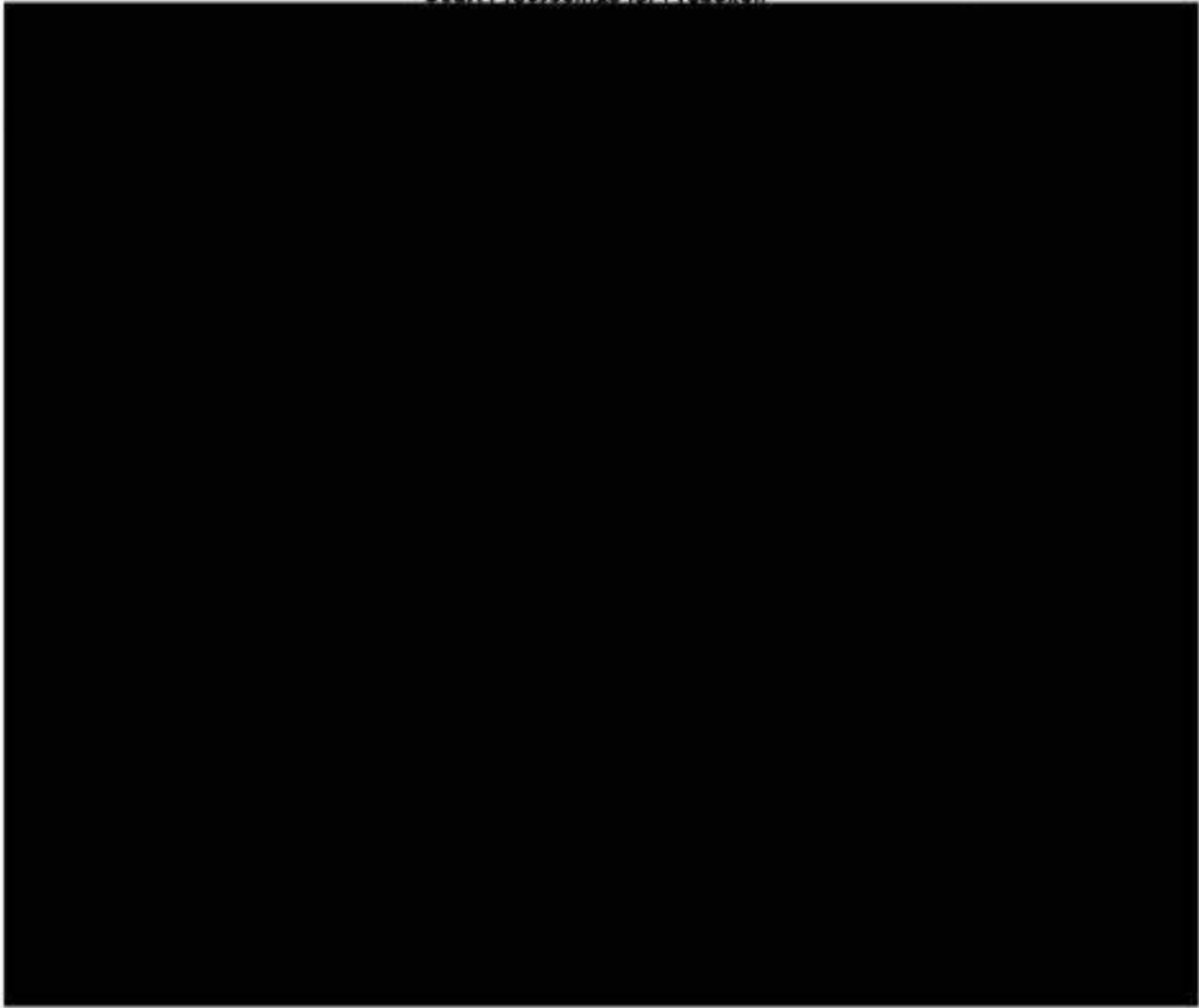

Run Date & Time: 11/15/2006 14:44

Case Number: 2006036265

Person Number: 3206977

Ventura County Superior/Municipal Courts

Court Proceedings for Probation

For Docket Activity From: 9/26/2006 thru 11/10/2006

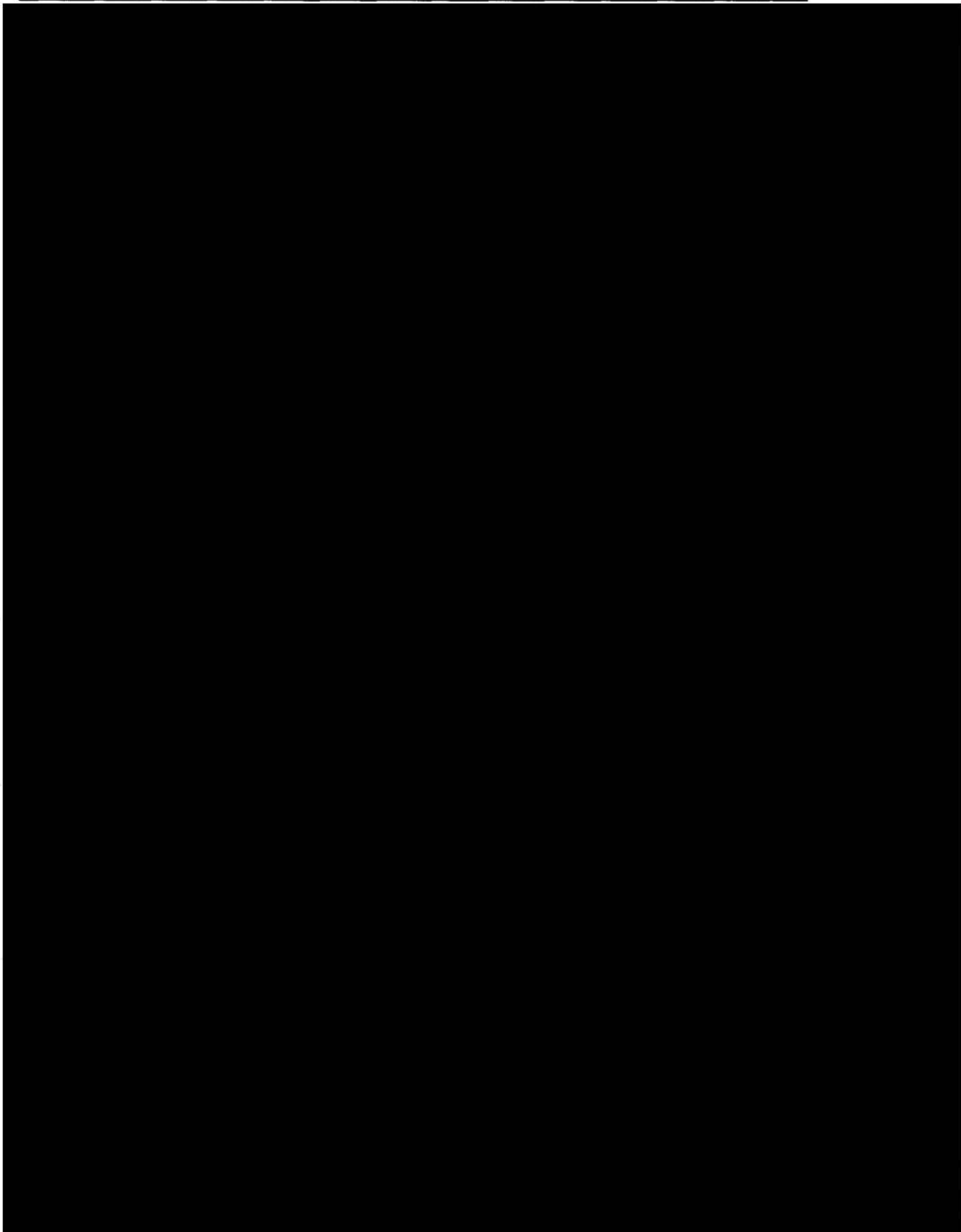

Run Date & Time: 11/15/2006 14:44

Case Number: 2006036265

Person Number: 3206977

Ventura County Superior/Municipal Courts

Court Proceedings for Probation

For Docket Activity From: 9/26/2006 thru 11/10/2006

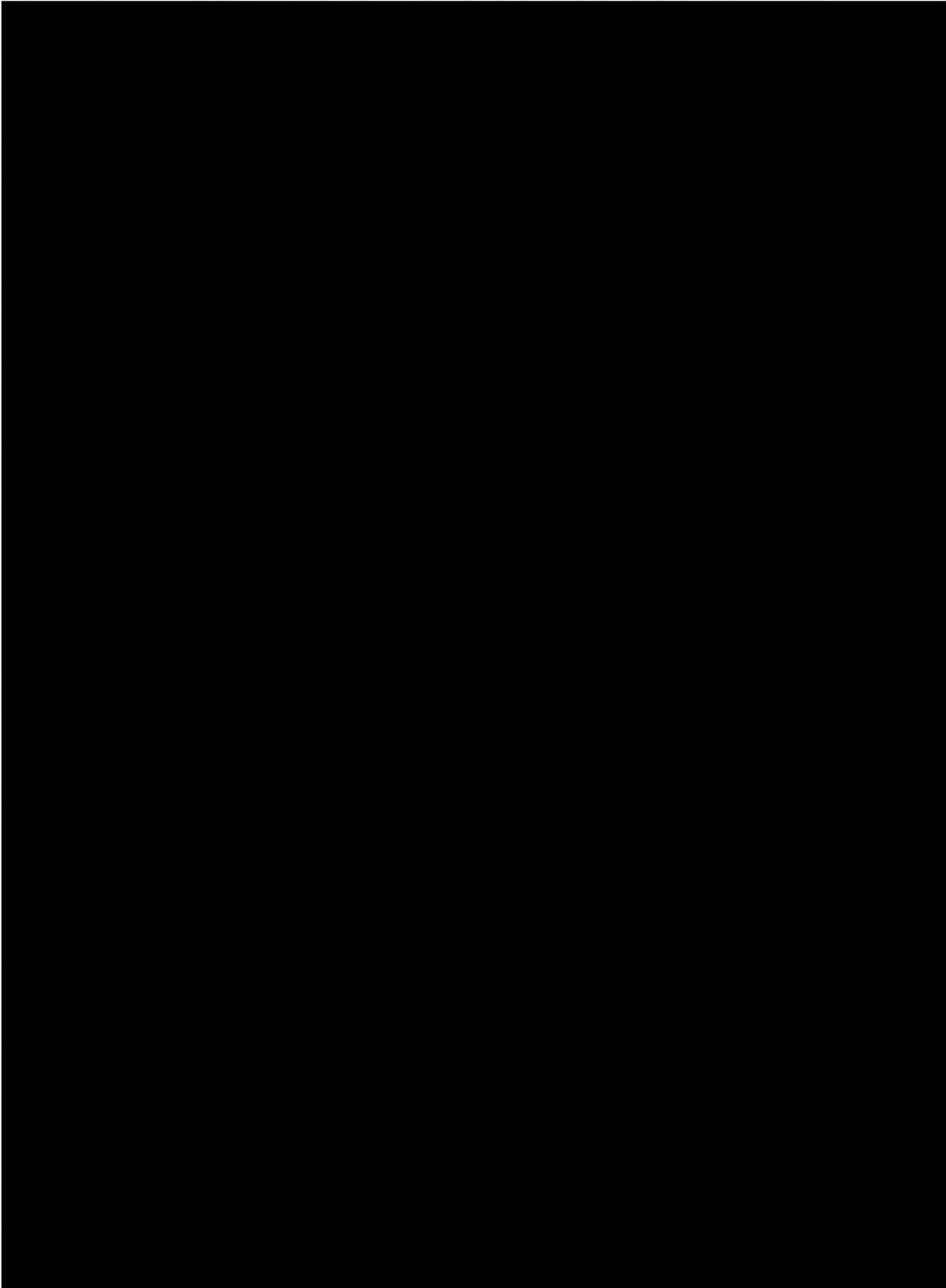

Run Date & Time: 11/15/2006 14:44

Case Number: 2006036265

Person Number: 3206977

Ventura County Superior/Municipal Courts

Court Proceedings for Probation

For Docket Activity From: 9/26/2006 thru 11/10/2006



Case Number: 2006036255

Terms & Conditions of Probation

Person Number: 3206977

For Docket Activity From: 9/26/2006 thru 9/26/2006

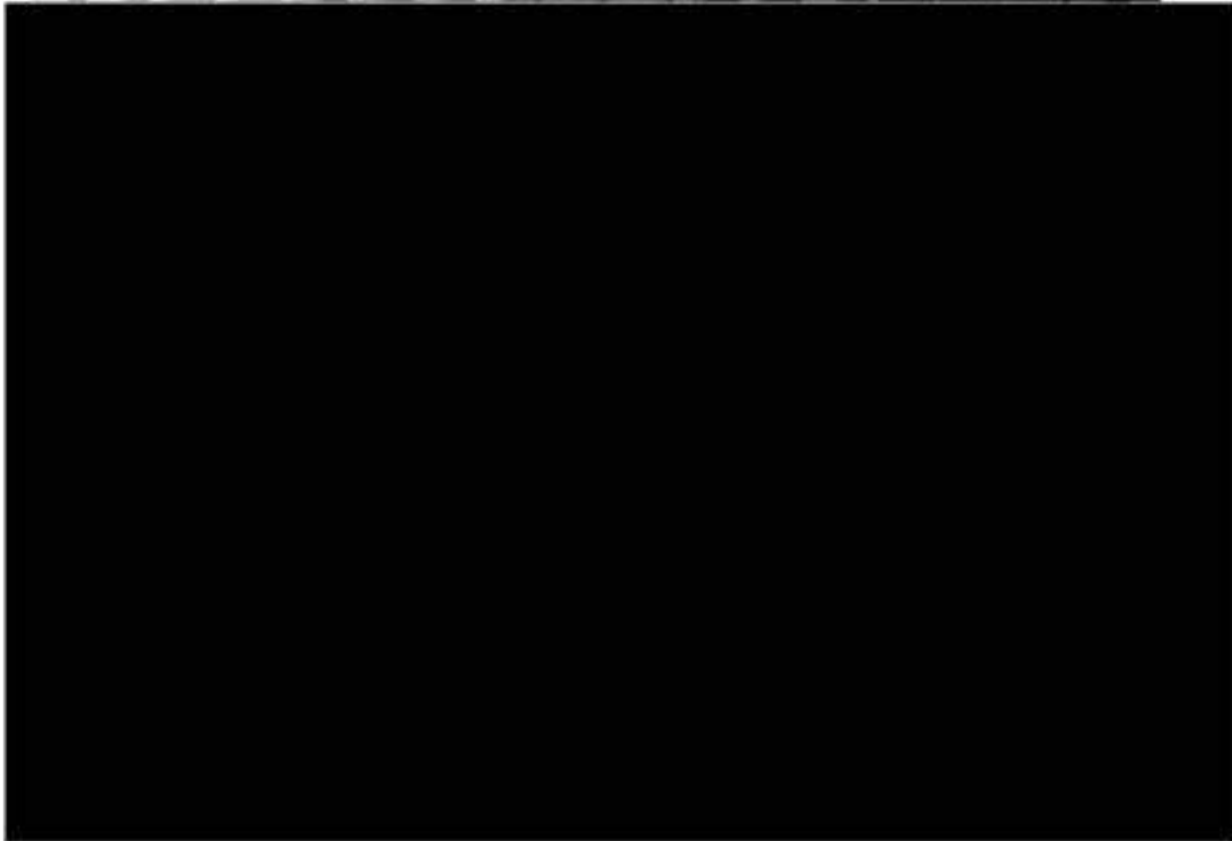



Run Date & Time: 11/15/2006 14:42

Case Number: 2006029308

Person Number: 3206977

Ventura County Superior/Municipal Courts

Court Proceedings for Probation

For Docket Activity From: 8/4/2006 thru 11/10/2006

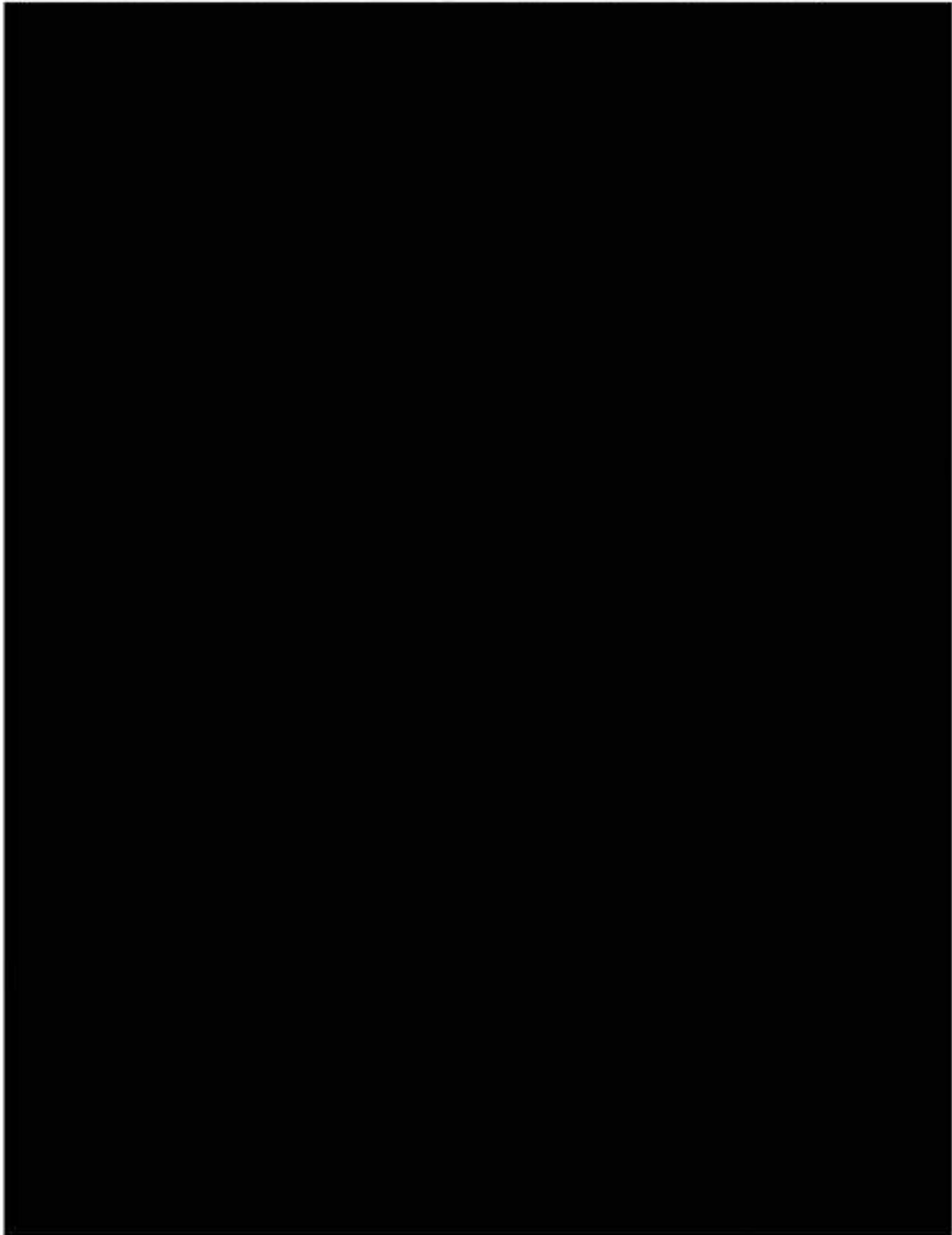

Run Date & Time: 11/15/2006 14:42

Case Number: 2006029308

Person Number: 3206977

Ventura County Superior/Municipal Courts

Court Proceedings for Probation

For Docket Activity From: 8/4/2006 thru 11/10/2006

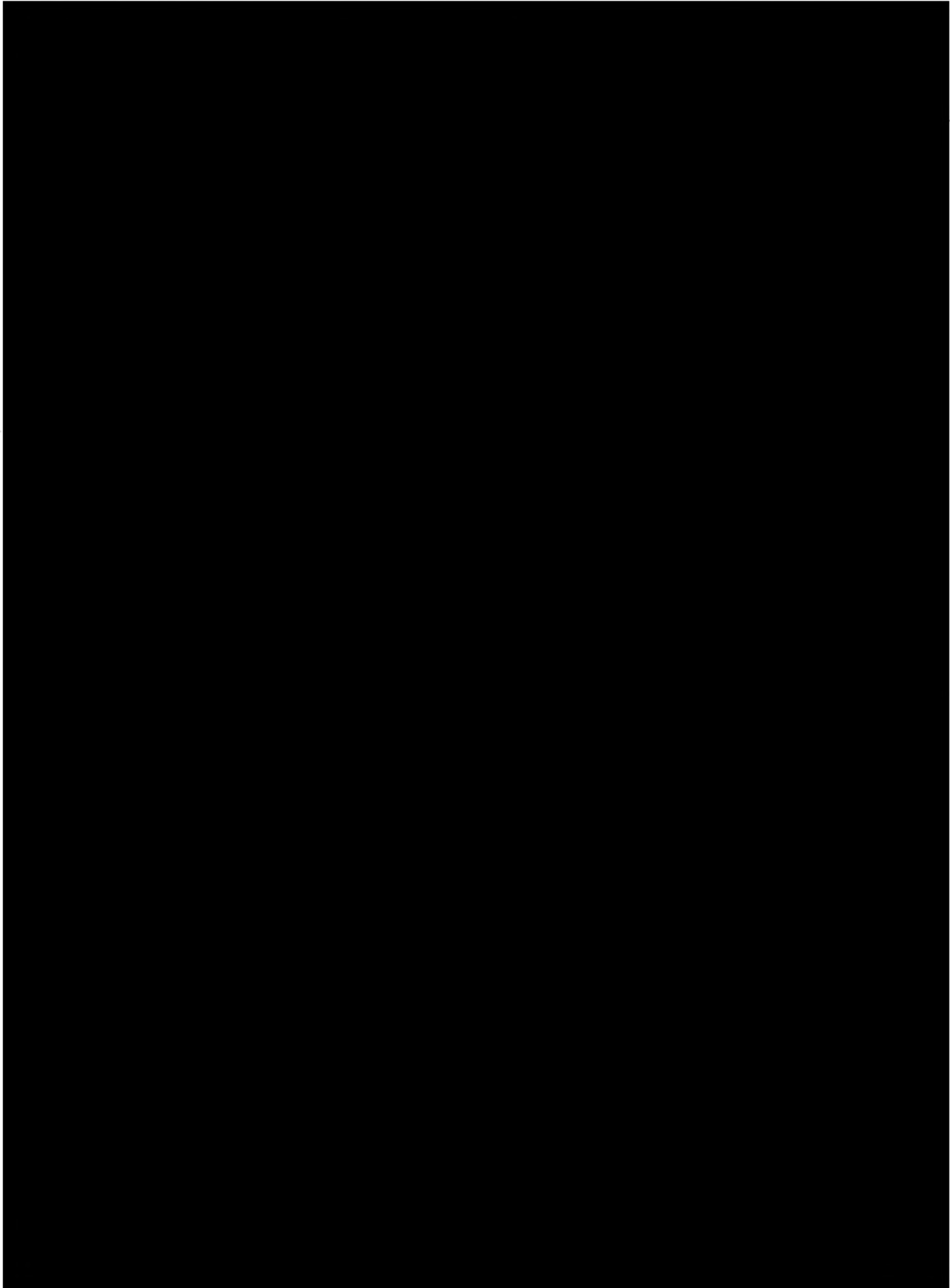

Run Date & Time: 11/15/2006 14:42

Case Number: 2006029308

Person Number: 3206977

Ventura County Superior/Municipal Courts

Court Proceedings for Probation

For Docket Activity From: 8/4/2006 thru 11/10/2006

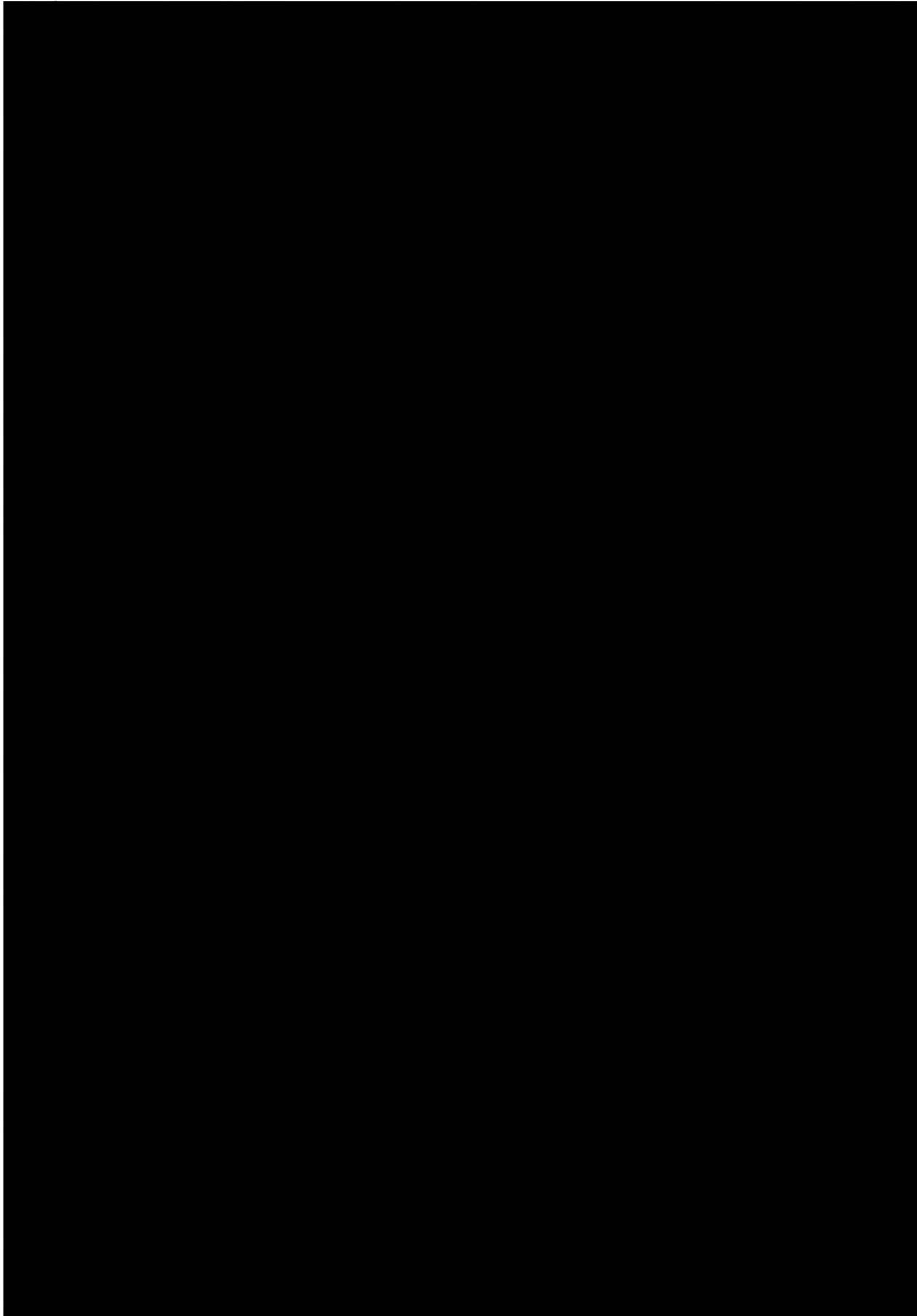

Run Date & Time: 11/15/2006 14:42
Case Number: 2006029308
Person Number: 3206977

Ventura County Superior/Municipal Courts
Court Proceedings for Probation
For Docket Activity From: 8/4/2006 thru 11/10/2006

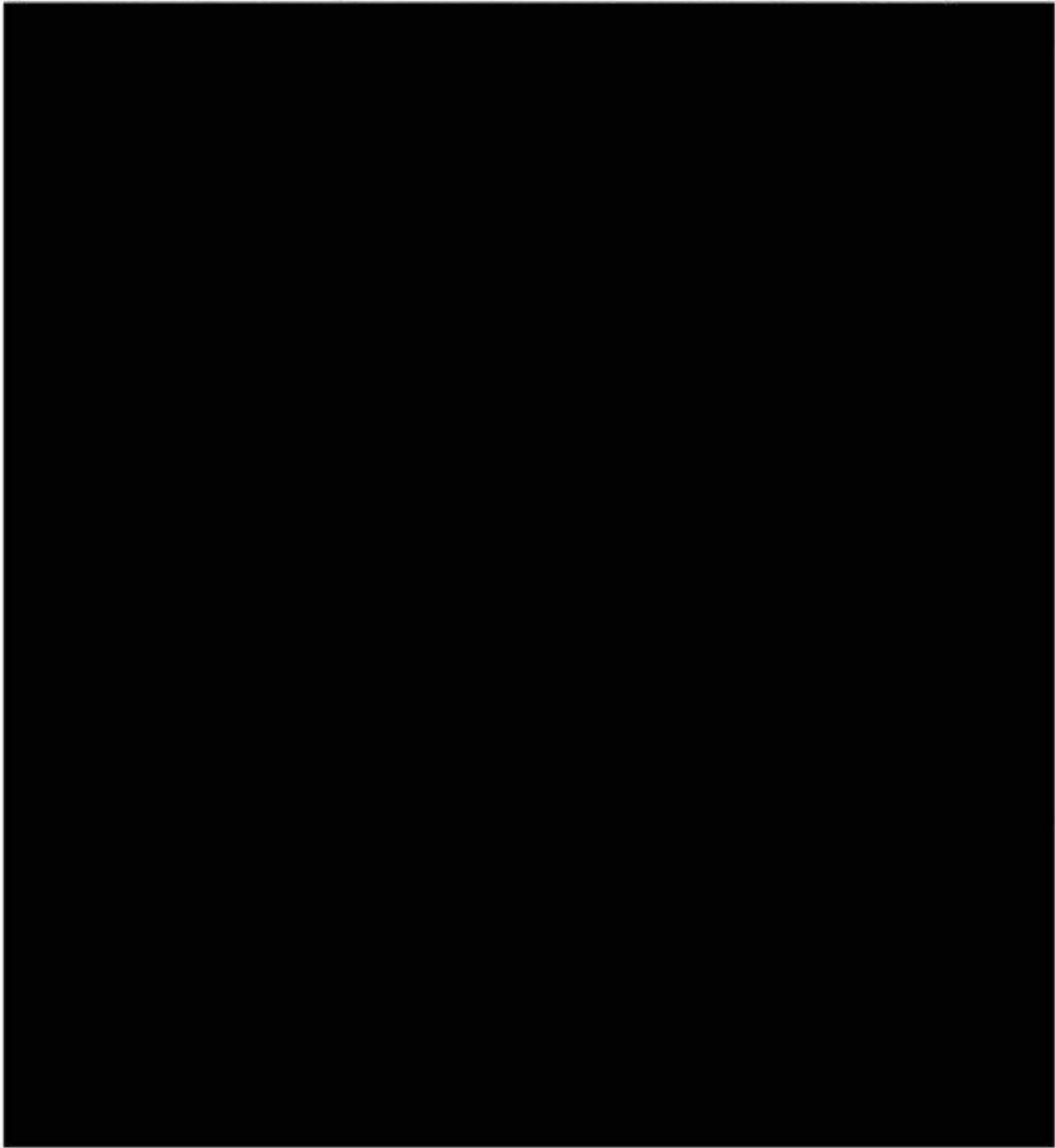

Case Number: 2006029308

Terms & Conditions of Probation

Person Number: 3208977

For Docket Activity From: 10/10/2006 thru 10/10/2006

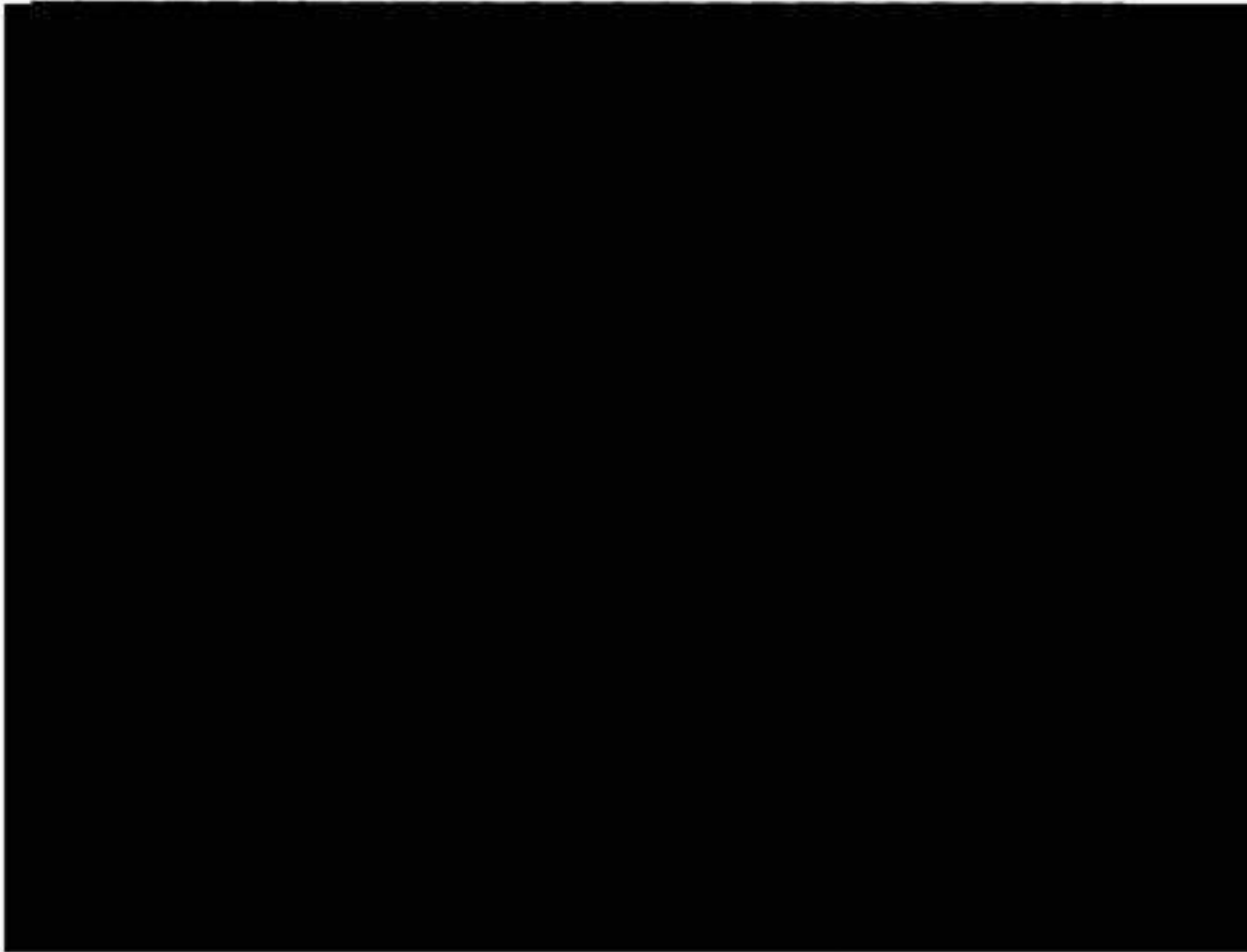

Date

Defendant's Signature

Telephone

Defendant's Address

Explained By

Defendant's City, State and Zip

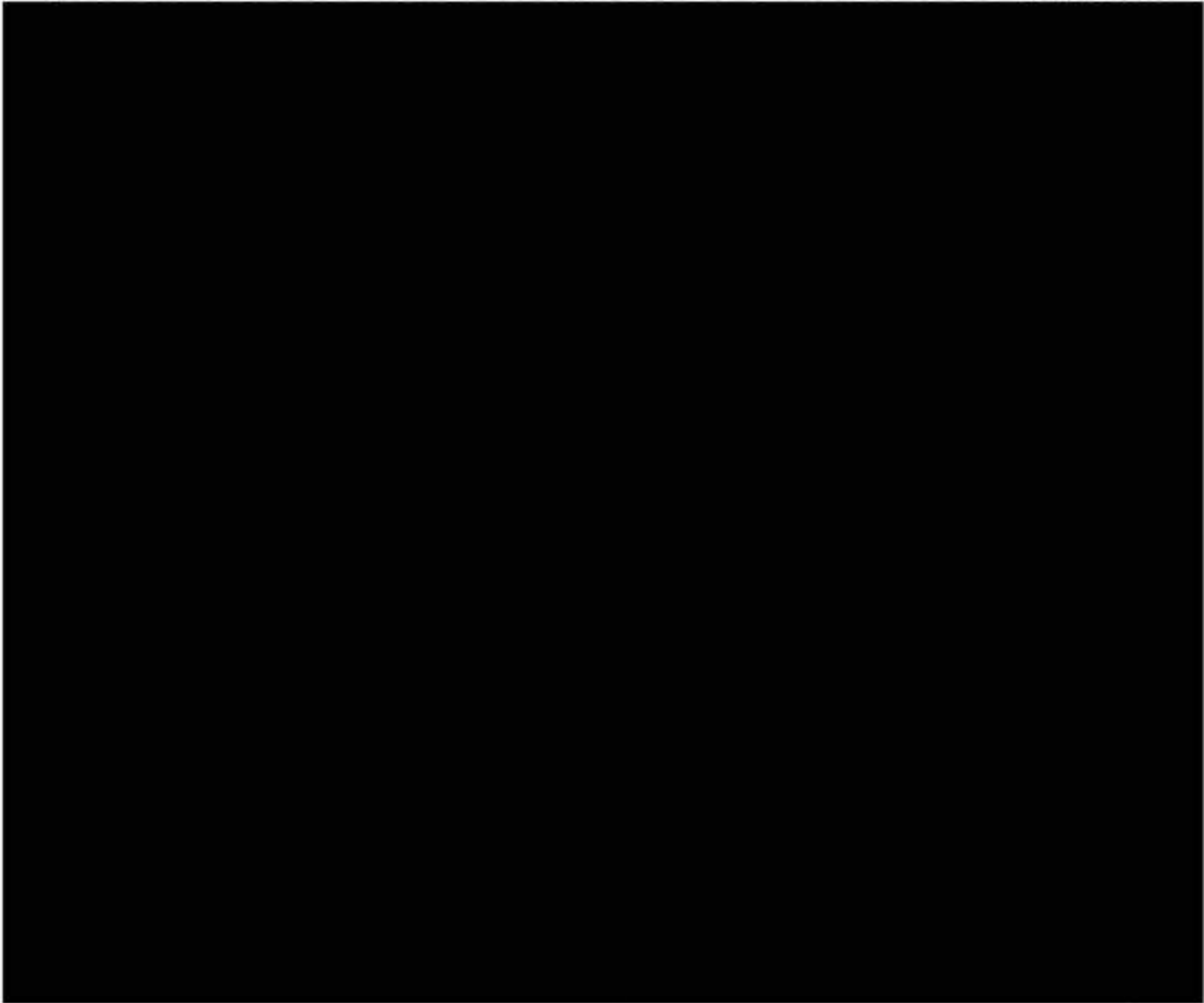

Reason(s) for Field Interviews

Traffic

NARRATIVE REPORT VENTURA COUNTY SHERIFF'S DEPARTMENT

19072 9001 08-30492

Page 3 of Continuation

AGENCY IDENTIFIER CA0560000

4 CODE	5 ITEM	6 QTY.	7 ITEM NAME	8 BRAND / MAKE MANUFACTURER	9 MODEL NAME OR NUMBER	10 MISC. DESCRIPTION	11 IDENTIFICATION / SERIAL NUMBER	12 VALUE
--------	--------	--------	-------------	-----------------------------	------------------------	----------------------	-----------------------------------	----------

Supplemental Case Cleared
 Gang Domestic Hate Child Abuse Elderly Abuse

Connecting Report Numbers:

Code Section / Description: Officer Involved Shooting

Reclassify to:

Code: P-1 Name: Canley, Adrian, Doyle



On 11-15-2006 at approximately 1330 hours I went to the Ceder Glen apartments located at [REDACTED] in the city of Oxnard. While at the apartments I spoke to the apartment manager, [REDACTED]. My reason for speaking to [REDACTED] was in an attempt to identify the residents of apartment number [REDACTED] in building [REDACTED] of the complex, [this apartment was determined to be connected to Adrian Canley sometime in the recent past].

I asked [REDACTED] if Adrian Canley was associated with that apartment and she said the residents that were residing there now were not related to Canley. However, [REDACTED] told me she did know Adrian Canley because he used to be a resident of the complex. [REDACTED] told me the mother of Canley's child, [REDACTED], still resided at the complex in building 1 [REDACTED], apartment number [REDACTED].

[REDACTED] continued on and related an incident that occurred between Adrian Canley and her approximately one month ago. [REDACTED] told me that Canley had parked his white pick-up truck in the fire lane inside the complex. [REDACTED] contacted Canley and asked him who he was because

13 DATE TIME OF REPORT 11-20-06 1557	14 REPORTING OFFICER ID NO AGENCY UNIT Sgt. J. Panza/#1204/Special Services	15 APPROVED BY AND NO Sgt. W. J. [Signature] 3318
---	--	--

NARRATIVE REPORT VENTURA COUNTY SHERIFF'S DEPARTMENT

Page 2 of 3 Continuation

AGENCY IDENTIFIER CA0560000

19972 9901 06-30492

4 CODE	5 ITEM	6 QTY.	7 ITEM NAME	8 BRAND / MAKE MANUFACTURER	9 MODEL NAME OR NUMBER	10 MISC. DESCRIPTION	11 IDENTIFICATION / SERIAL NUMBER	12 VALUE
--------	--------	--------	-------------	-----------------------------	------------------------	----------------------	-----------------------------------	----------

she did not immediately recognize him. [REDACTED] said she then realized who Canley was, and that he had previously resided in apartment [REDACTED] but had moved out approximately 6 months prior.

[REDACTED] saw that Canley still had an apartment complex parking permit on his vehicle and in addition to asking him to move his truck out of the fire lane, asked him for the parking permit because he was no longer a resident of the complex. [REDACTED] said Canley refused to give it to her, and told her he was visiting the mother of his child and getting his "stuff". [REDACTED] said Canley said he would leave after he was finished.

[REDACTED] said she again asked Canley for the parking permit and, "from that point on it escalated to name calling... and he just started calling me names from the time he was loading his truck". [REDACTED] said Canley was calling her a "fucking bitch, and "you bucked tooth bitch...your in my business, and you have no business being in my business". [REDACTED] said Canley kept on repeating these insults. [REDACTED] said at that point she called the police who came and contacted Canley. [REDACTED] said the police told Canley he needed to get his property and leave. [REDACTED] said Canley finished getting his stuff and he then left.

[REDACTED] said the encounter involving Canley lasted approximately 1 hour, and that Canley did not get violent..."just mouthy". [REDACTED] said once the police arrived Canley started to calm down. [REDACTED] said she did feel threatened during the incident and several of her friends and residents came outside during the incident. [REDACTED] said the incident took place sometime in the afternoon. [REDACTED] said other than being loud, she could not tell if Canley appeared to be under the influence of alcohol or drugs, nor could she tell if he appeared to be suffering from any type of mental problem. [REDACTED] said prior to this incident she never had any problems with Canley, so she was "taken aback" by his behavior. [REDACTED] said she has not seen Canley since this incident.

I also later interviewed the assistant manager of the complex, [REDACTED] Sheaffer. [REDACTED] told me she did not know Canley well but she never had any problems with him, even when she had to serve him with eviction papers. [REDACTED] said Canley was polite to her when she dealt with him, and that he appeared to be a quiet person.

13 DATE OF THIS REPORT 11-20-06 / 1557	14 REPORTING OFFICER / ID NO. / UNIT Sgt. J. Panza / #1204 / Special Services	15 APPROVED BY / ID NO. Sgt. W. J. [Signature] / 3318
---	--	--

NARRATIVE REPORT VENTURA COUNTY SHERIFF'S DEPARTMENT

1 9072 2 9001 3 06-30492

Page 3 of 3 Continuation

AGENCY IDENTIFIER CA0560000

4 CODE	5 ITEM	6 QTY.	7 ITEM NAME	8 BRAND / MAKE MANUFACTURER	9 MODEL NAME OR NUMBER	10 MISC. DESCRIPTION	11 IDENTIFICATION / SERIAL NUMBER	12 VALUE
-----------	-----------	-----------	-------------------	-----------------------------------	------------------------------	----------------------------	---	-------------

These interviews were fragmented at times and I organized them semi chronologically for ease of reading. These interviews were also digitally recorded and for complete details of the interviews refer to the digital recording.

13 DATE / TIME OF REPORT
11-20-06 / 1557

14 REPORTING OFFICER / ID NO / DIV / UNIT
Sgt. J. Panza / #1204 / Special Services

15 APPROVED BY / ID NO
Sgt. W. J. Ap 3318

SANTA PAULA POLICE DEPARTMENT

214 SOUTH 10TH STREET
SANTA PAULA, CALIFORNIA 93060
Phone (805) 933-4230
Fax (805) 525-0678

SG0603839
Case Number

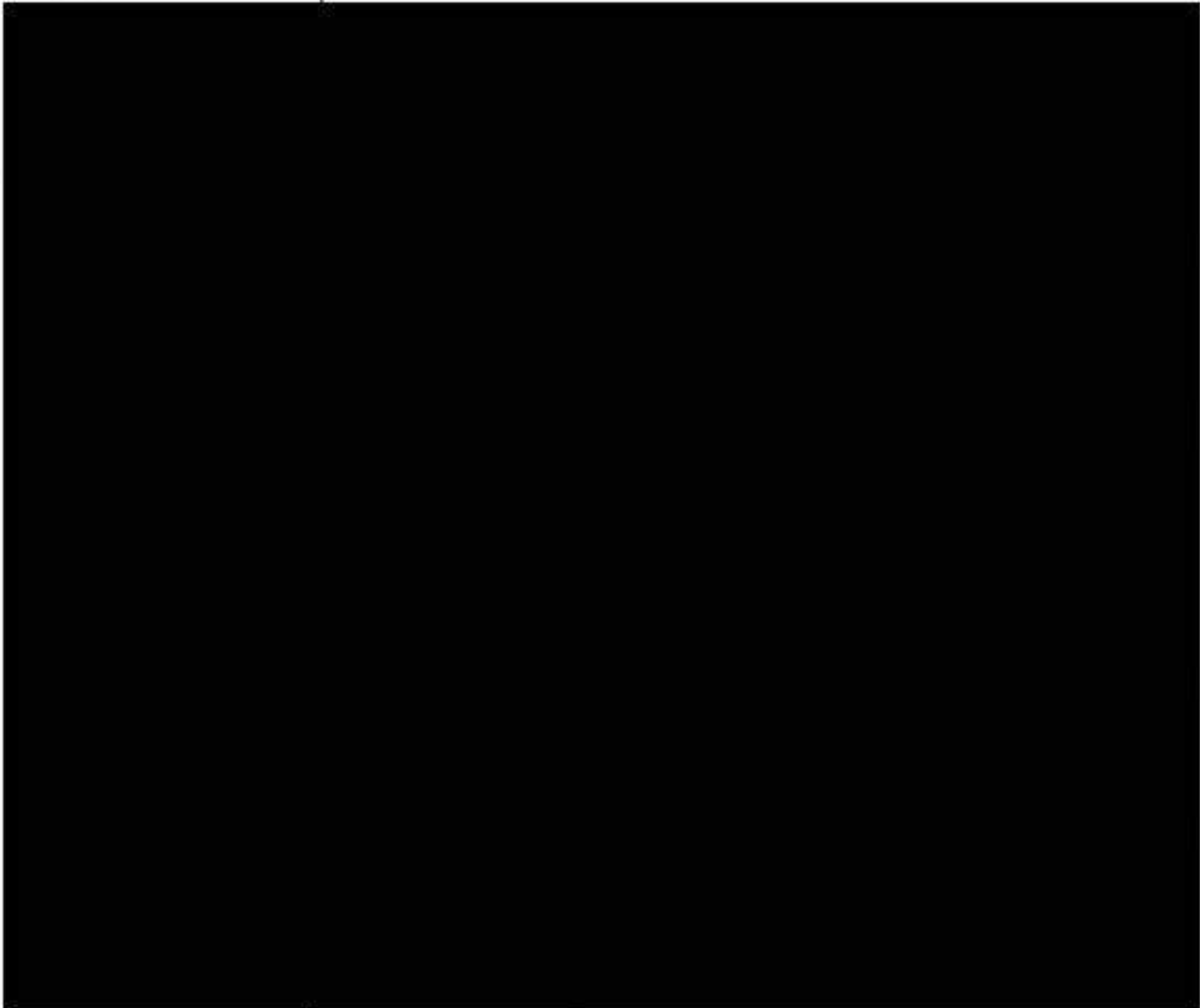

Released By: _____

Received By: _____

Date: _____

11/16/2006 5:09:02PM
Print Date/Time

SANTA PAULA POLICE DEPARTMENT

214 SOUTH 10TH STREET
 SANTA PAULA, CALIFORNIA 93060
 Phone (805) 933-4230
 Fax (805) 525-0678

SG0603839

Case Number

INVESTIGATION	EVIDENCE OBTAINED	SOLVABILITY
<ul style="list-style-type: none"> <input type="checkbox"/> = Dusted For Latents <input type="checkbox"/> = Tool Marks Noted <input type="checkbox"/> = Vehicle / Shoe Tracks <input type="checkbox"/> = Photo Impressions Taken <input type="checkbox"/> = Scene Photographed <input type="checkbox"/> = Photo(s) Of Victim Taken <input type="checkbox"/> = Diagram Of Scene <input type="checkbox"/> = Neighbors Contacted <input type="checkbox"/> = Area Checked <input type="checkbox"/> = Witnesses Contacted <input type="checkbox"/> = Victim Contacted <input type="checkbox"/> = Other (See Narrative) 	<ul style="list-style-type: none"> <input type="checkbox"/> = Finger Prints <input type="checkbox"/> = Other Prints <input type="checkbox"/> = Weapon / Tools <input type="checkbox"/> = Vehicle <input type="checkbox"/> = Photos <input type="checkbox"/> = Hair <input type="checkbox"/> = Stains <input type="checkbox"/> = Blood / Semen <input type="checkbox"/> = Other (See Narrative) <input type="checkbox"/> = None <div style="text-align: center; border: 1px solid black; width: fit-content; margin: 0 auto; padding: 2px;"> Approval APPROVED </div>	<ul style="list-style-type: none"> <input type="checkbox"/> = Was Suspect Arrested <input type="checkbox"/> = Can Suspect Be Named <input type="checkbox"/> = Can Suspect Be Located <input type="checkbox"/> = Can Suspect Be Ident. <input type="checkbox"/> = Witness To Crime <input type="checkbox"/> = Significant M.O. Present <input type="checkbox"/> = Property Traceable <input type="checkbox"/> = Significant Evidence <input type="checkbox"/> = All Elements Present <input type="checkbox"/> = Major Injury or Rape <input type="checkbox"/> = Can Suspect be Described <input type="checkbox"/> = Can Suspect Vehicle be ID <input type="checkbox"/> = Is There Significant Reason to Believe Crime Can be Solved

Copies To _____

Signature Verifying Original Copy of Case: _____ Date: _____
 Released By: _____ Received By: _____ Date: _____

11/16/2006 5:09:02PM
 Print Date/Time

SANTA PAULA POLICE DEPARTMENT

214 South 10th Street
Santa Paula, CA 93060

CA0560600

Phone (805) 933-4230
Fax (805) 525-0678

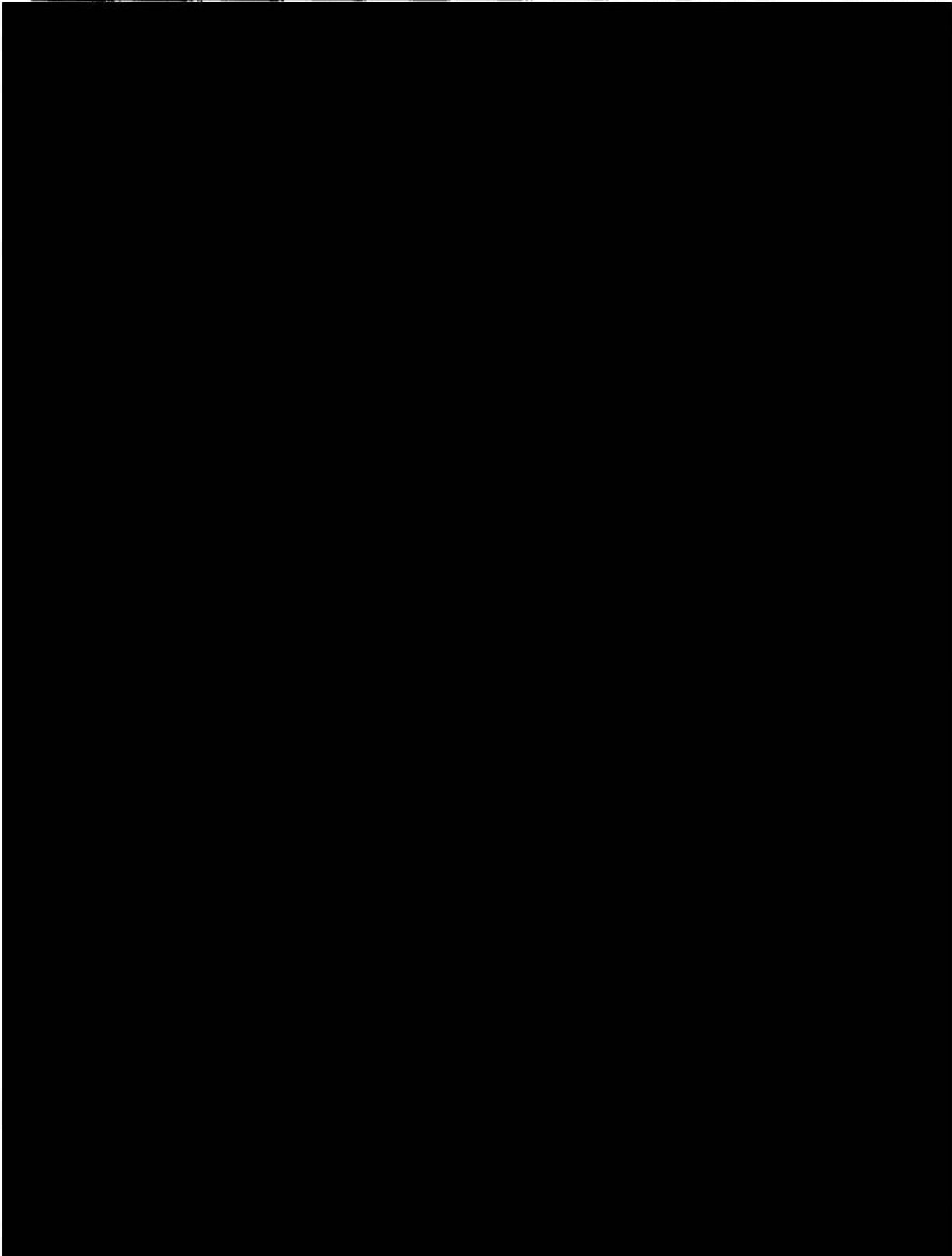

SANTA PAULA POLICE DEPARTMENT

214 South 10th Street
Santa Paula, CA 93060

CA0580600

Phone (805) 933-4230

Fax (805) 525-0678

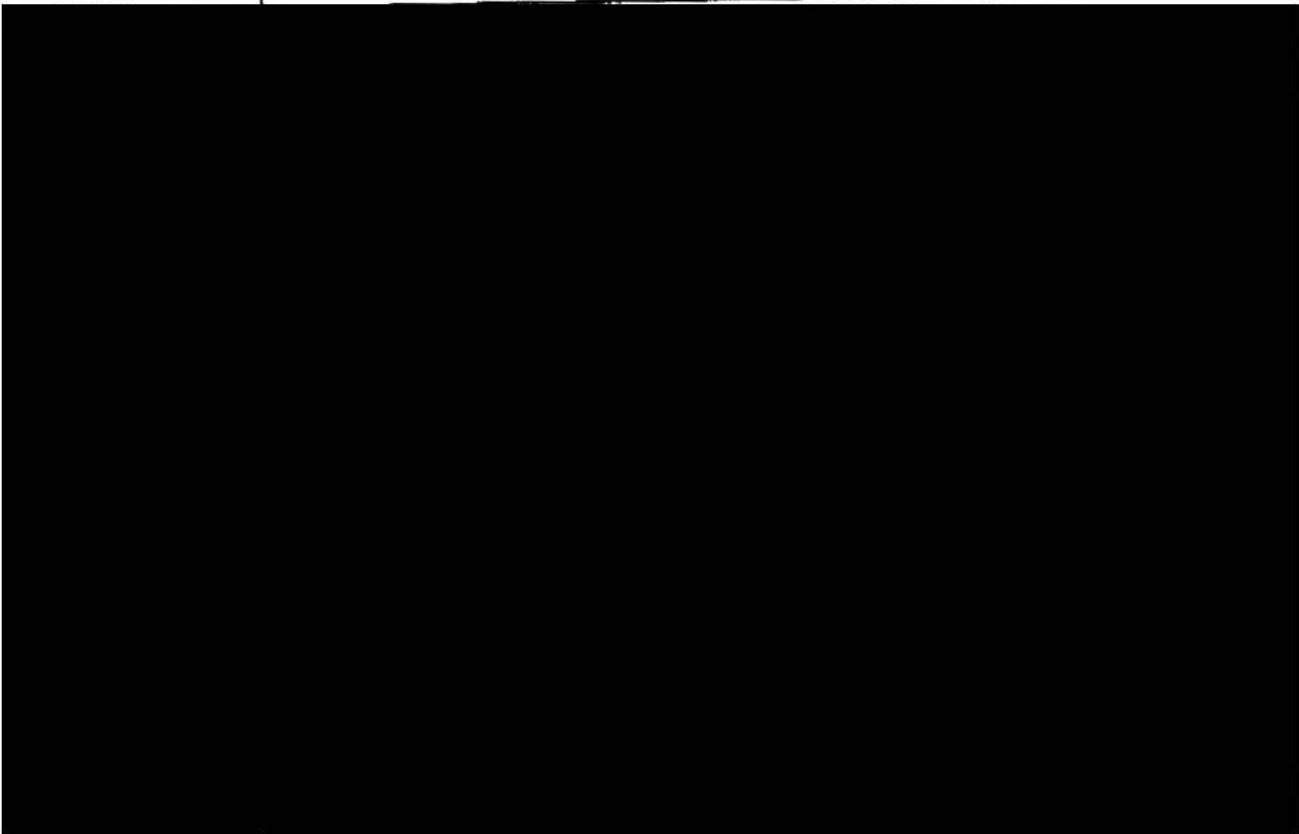

Approved

11/15/2006 09:13 AM

LT. SAVIERS



**POLICE DEPARTMENT
CRIME REPORT**

CASE NUMBER:	06-26811
---------------------	-----------------





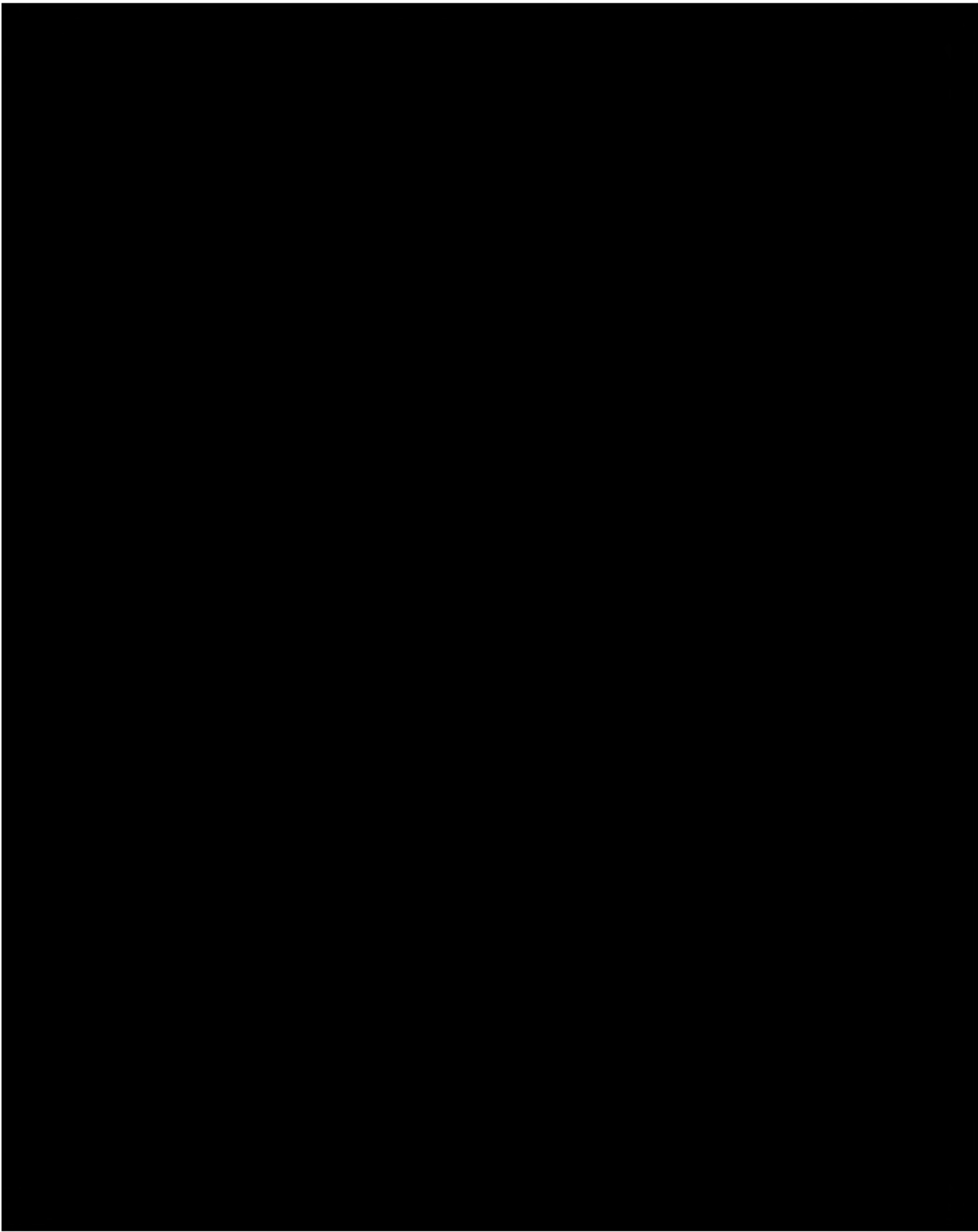

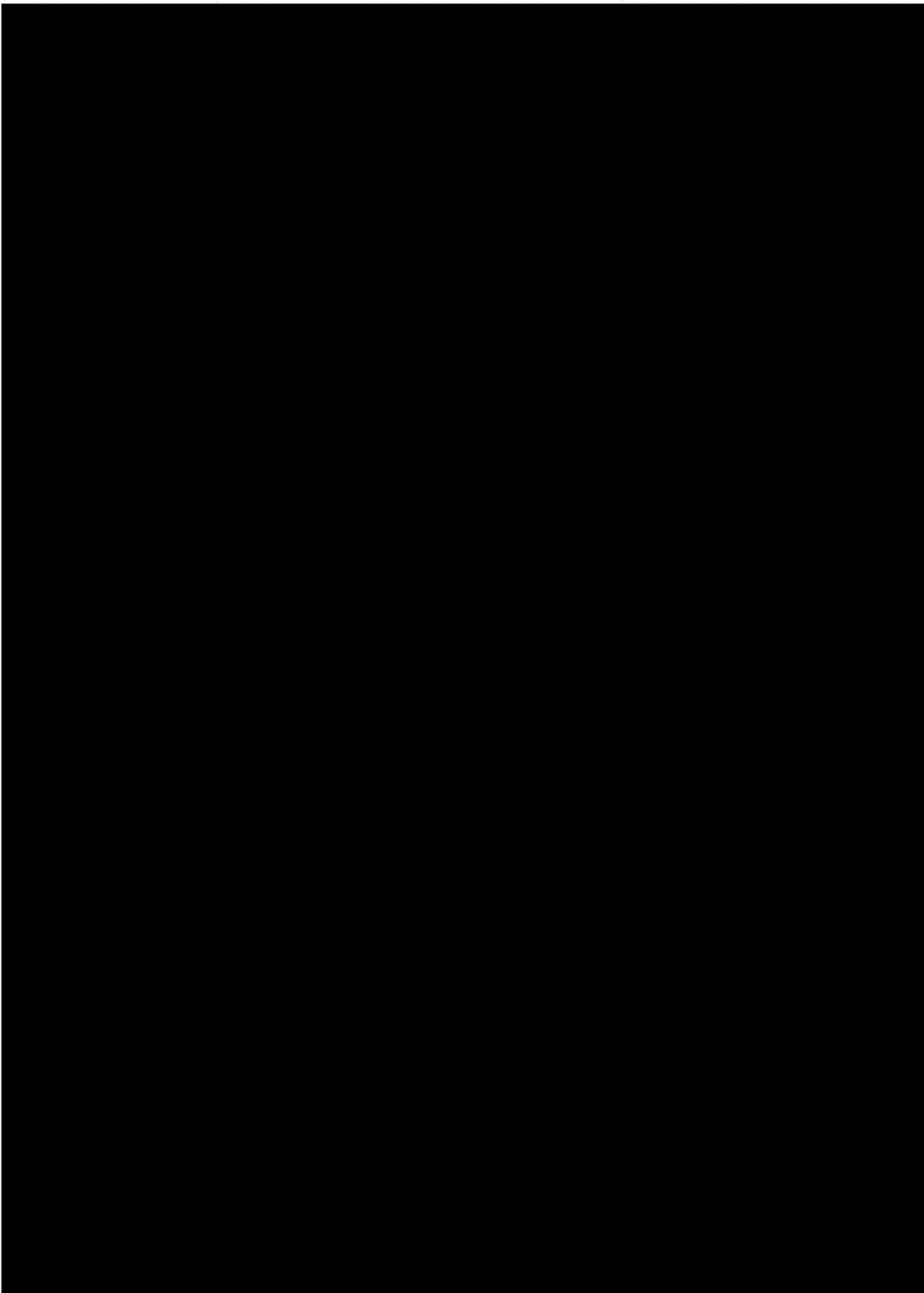

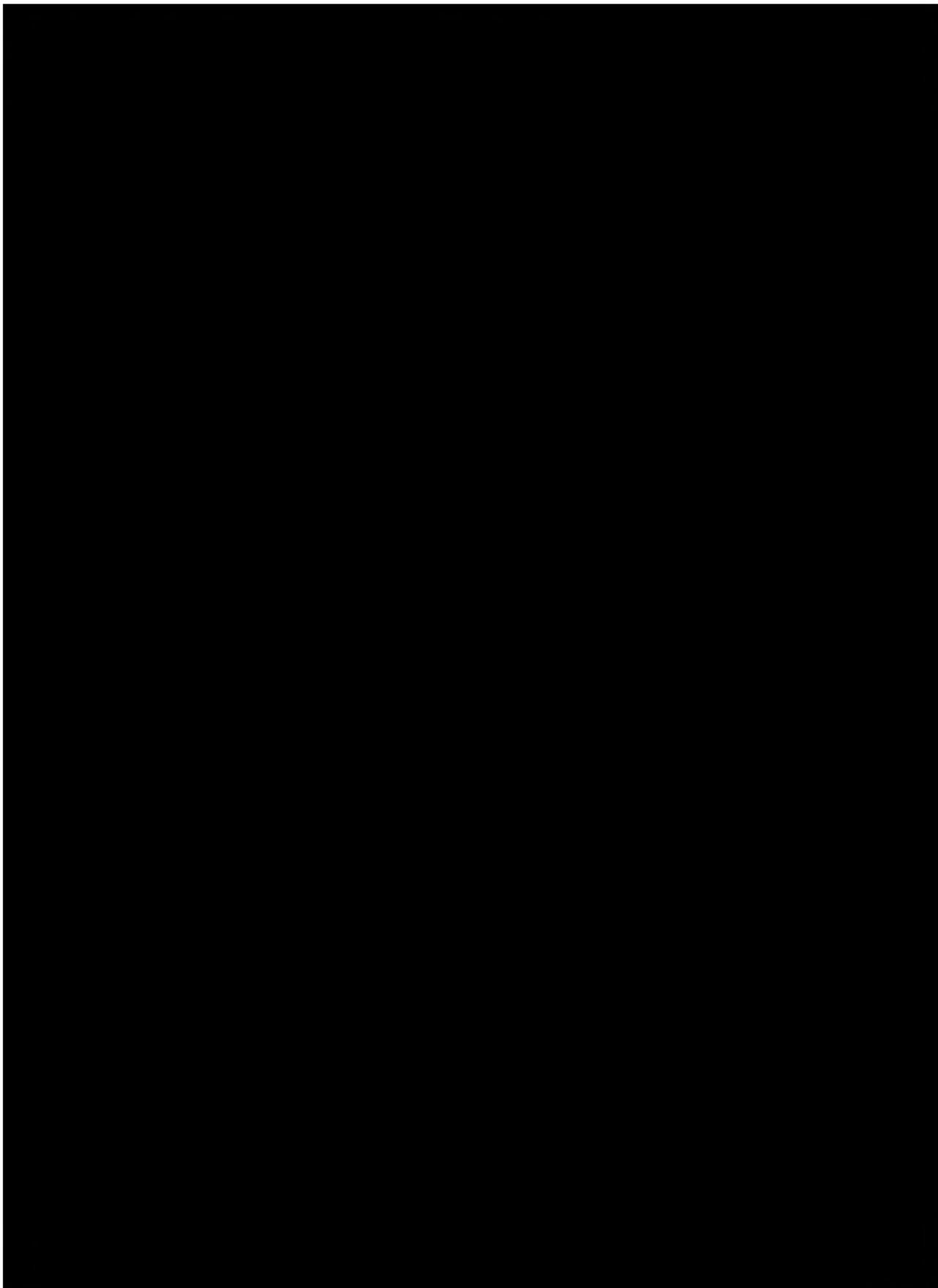

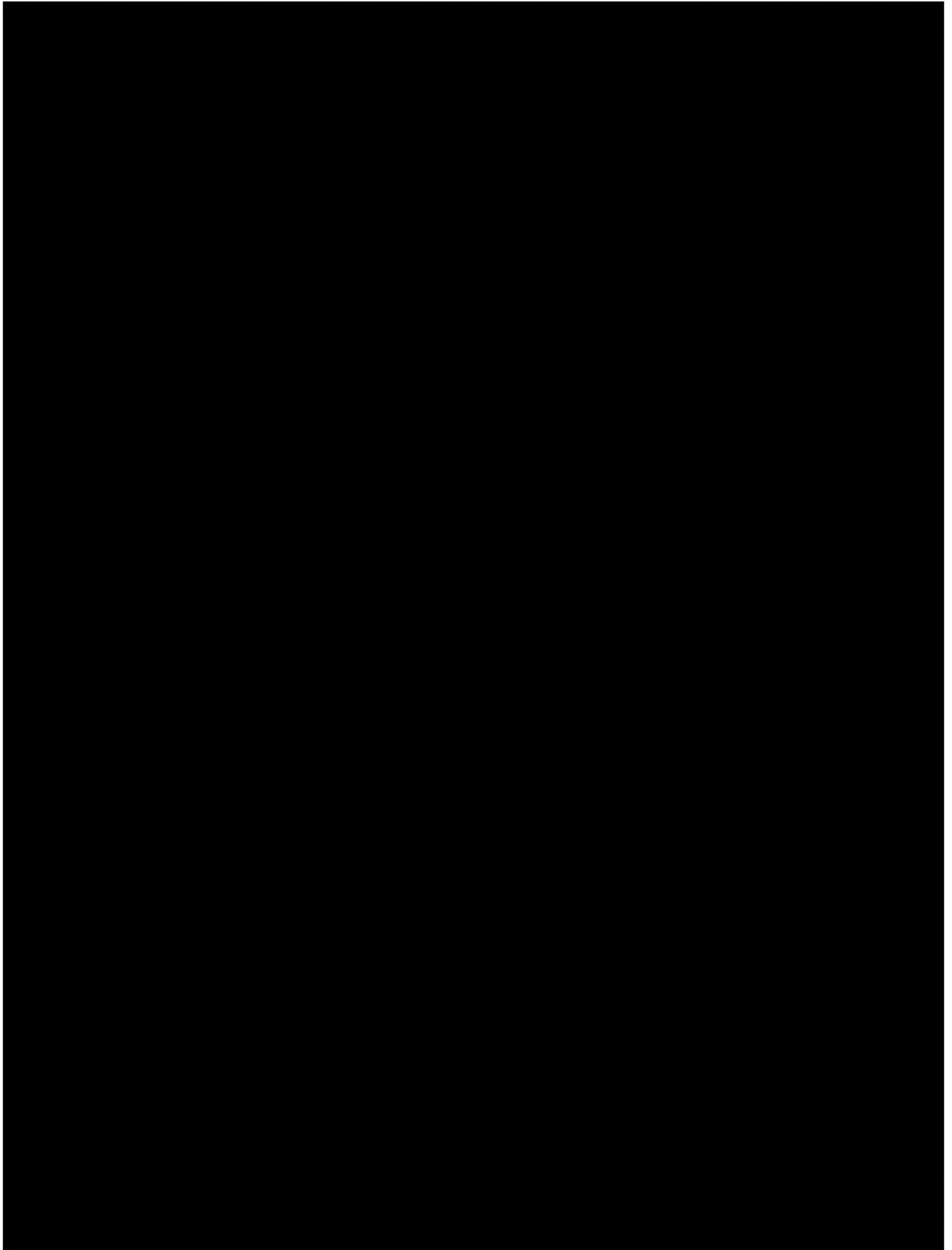

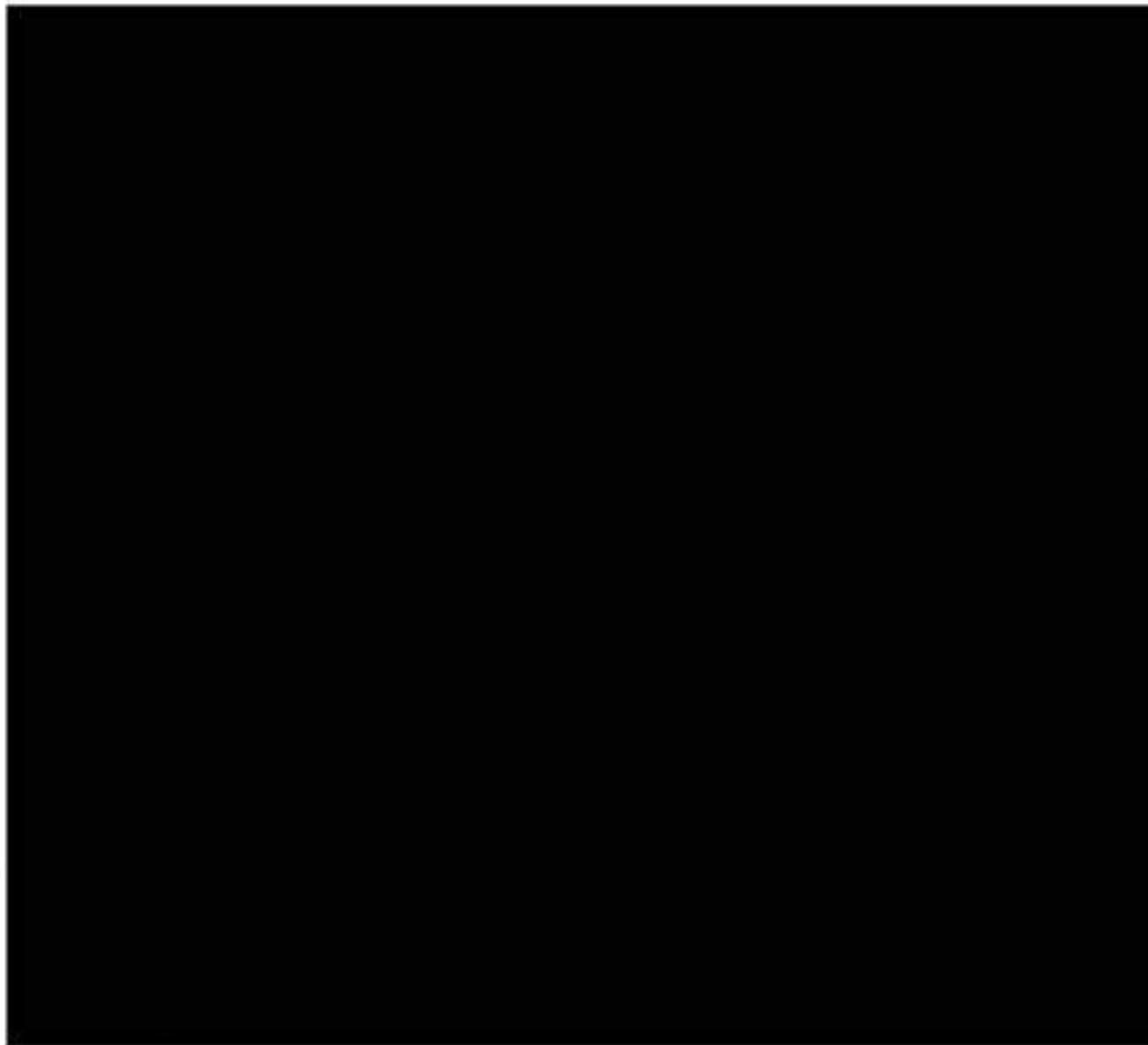

END OF REPORT - Michael Velasquez



**POLICE DEPARTMENT
CRIME REPORT**

CASE NUMBER:	06-25767
---------------------	-----------------



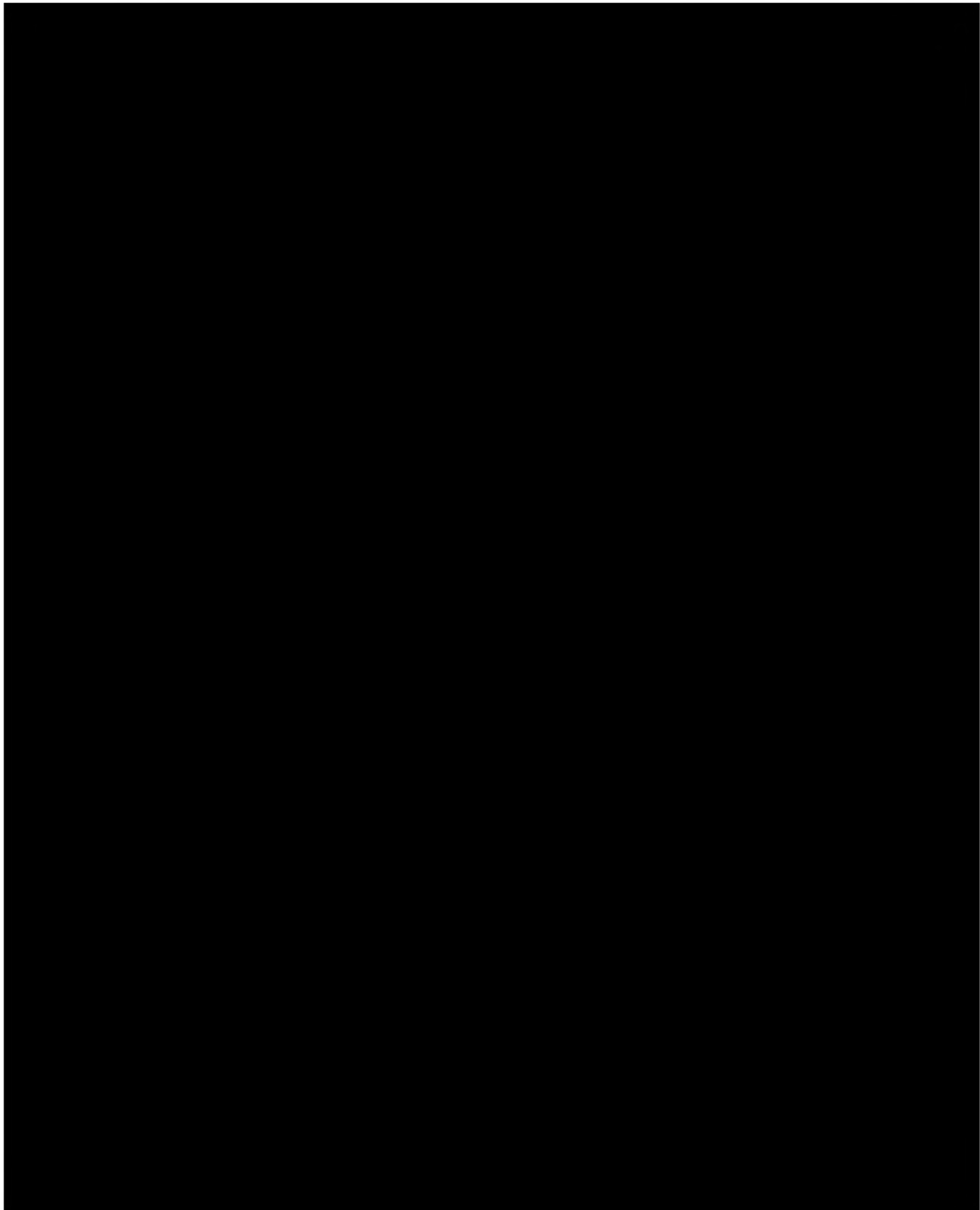

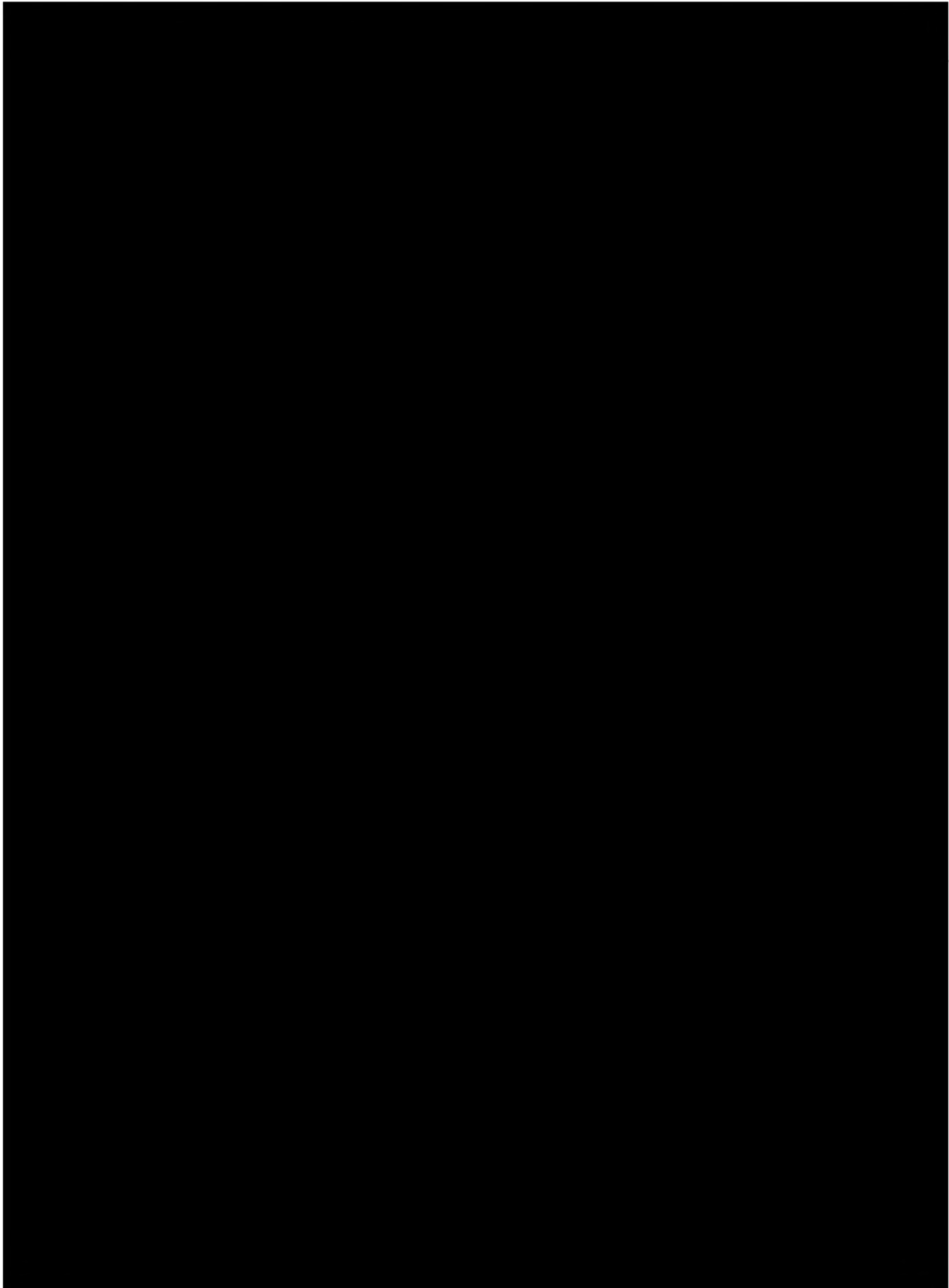

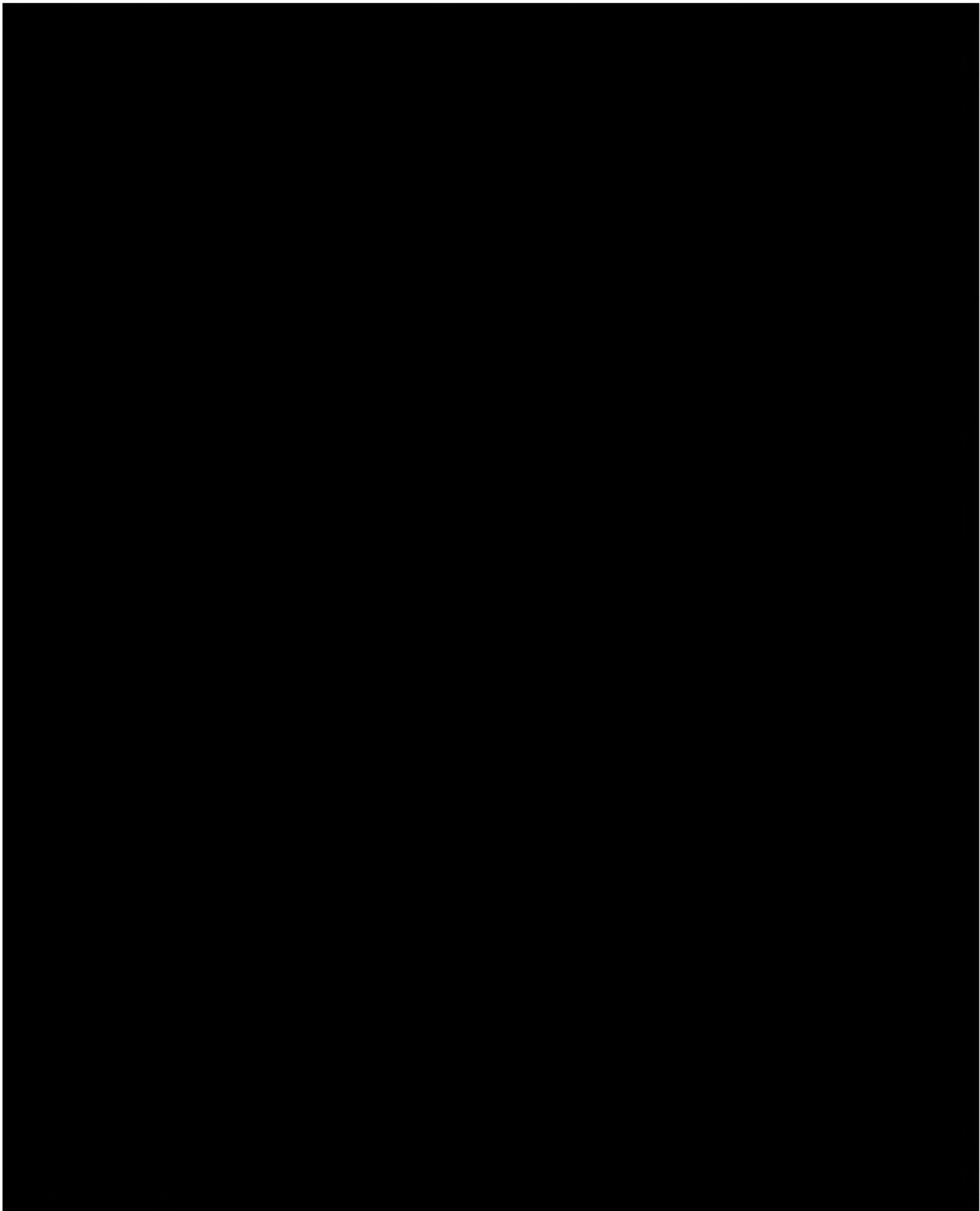

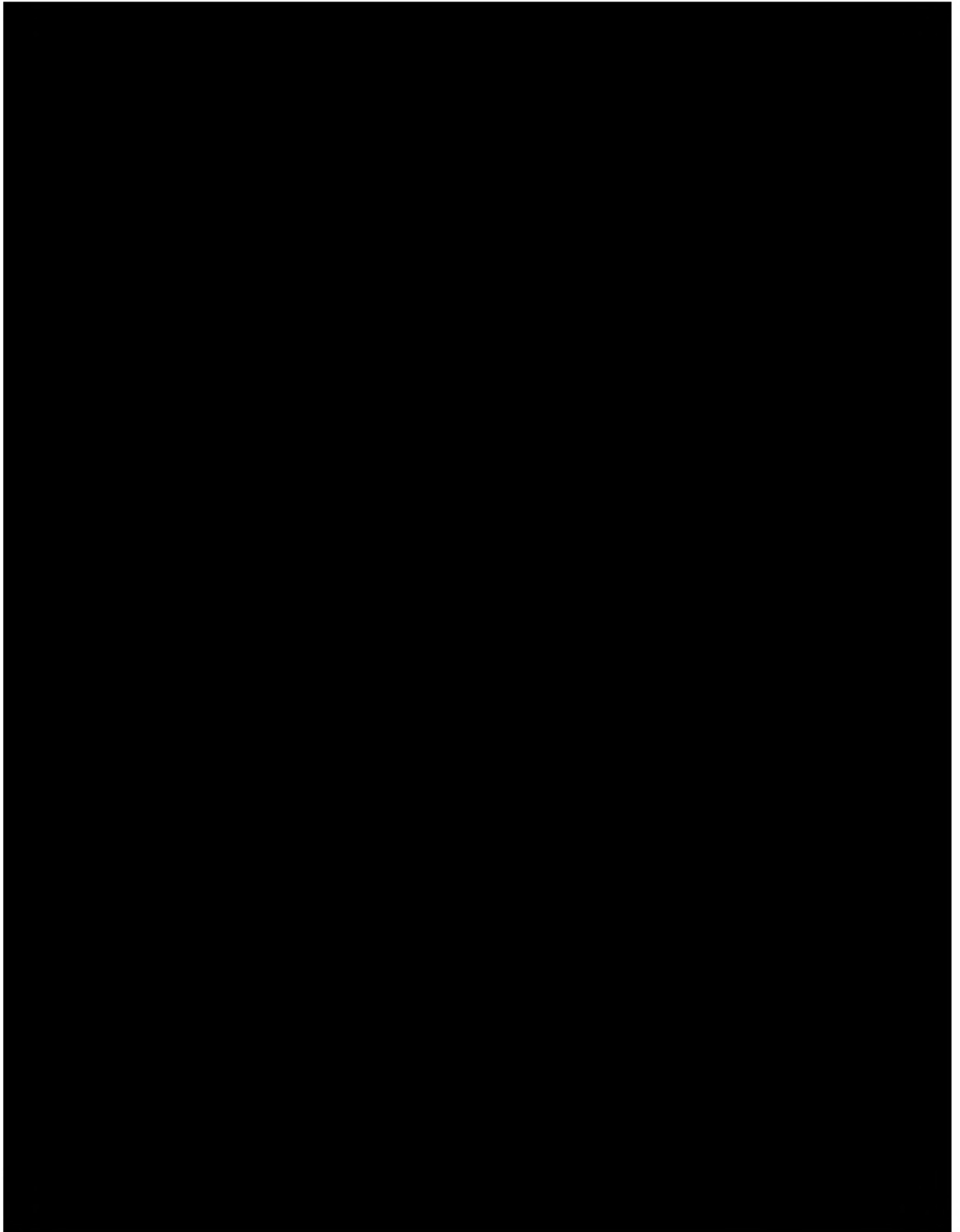

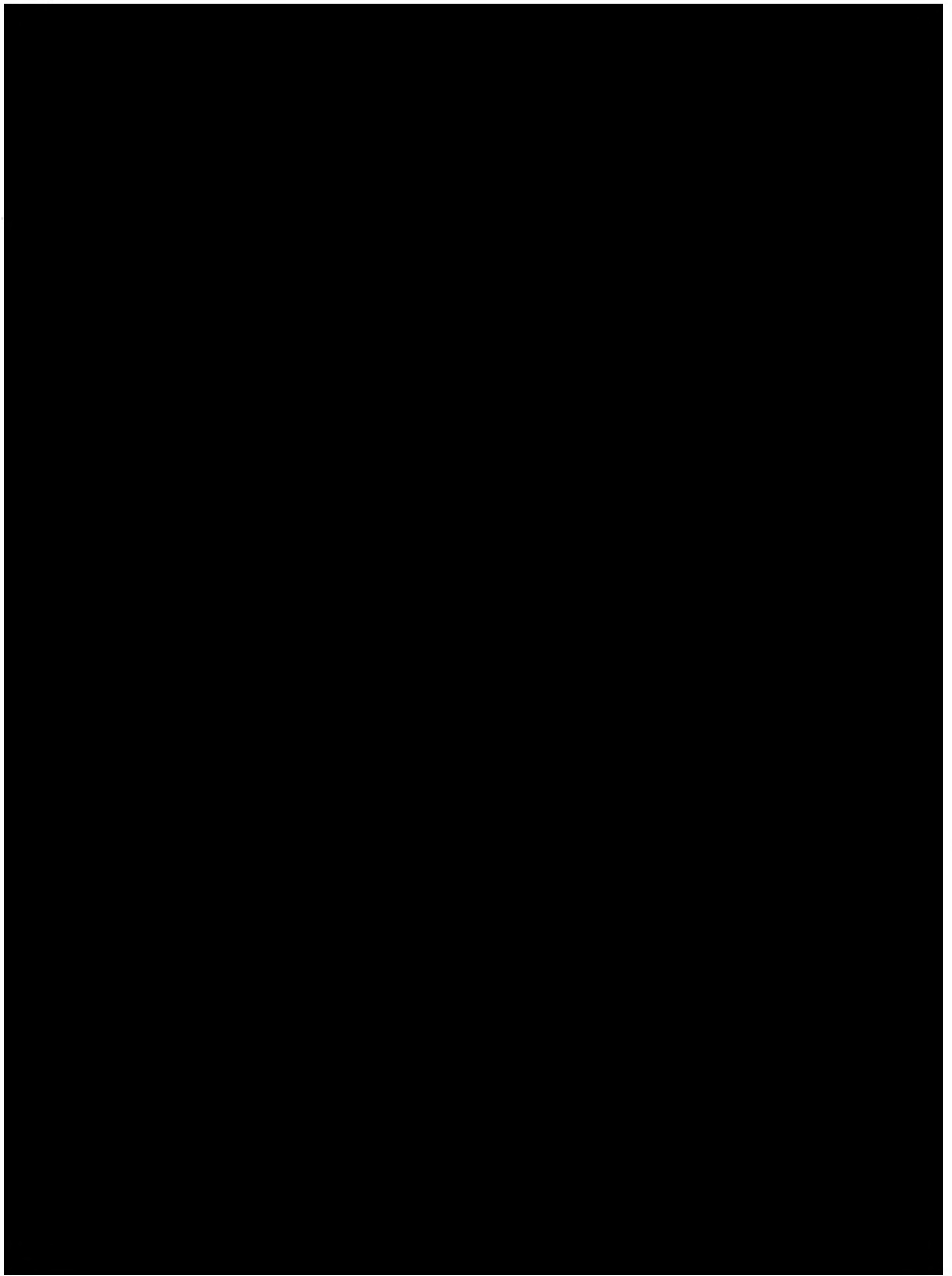



**OXNARD POLICE DEPARTMENT
FOLLOW-UP REPORT**

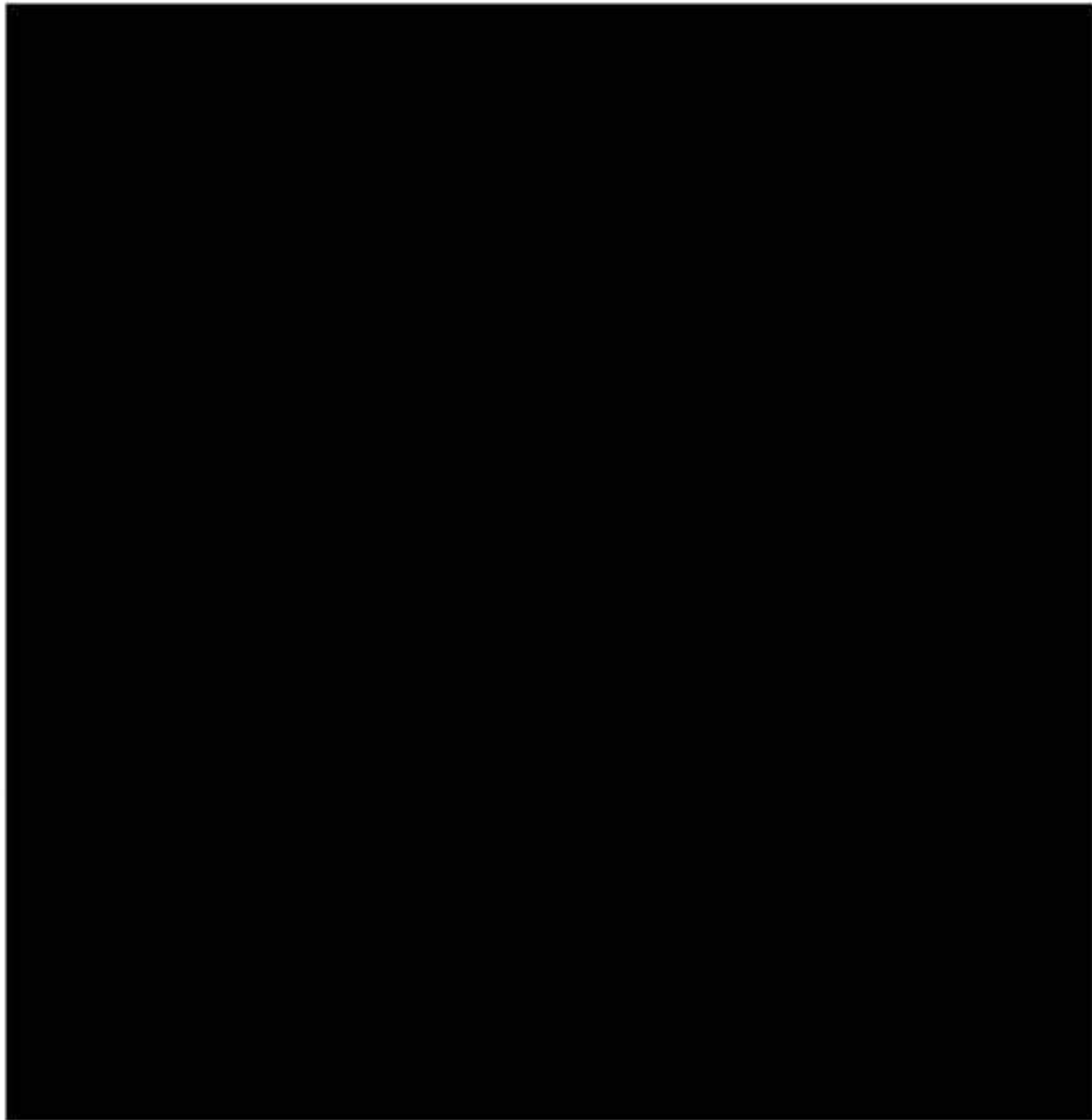

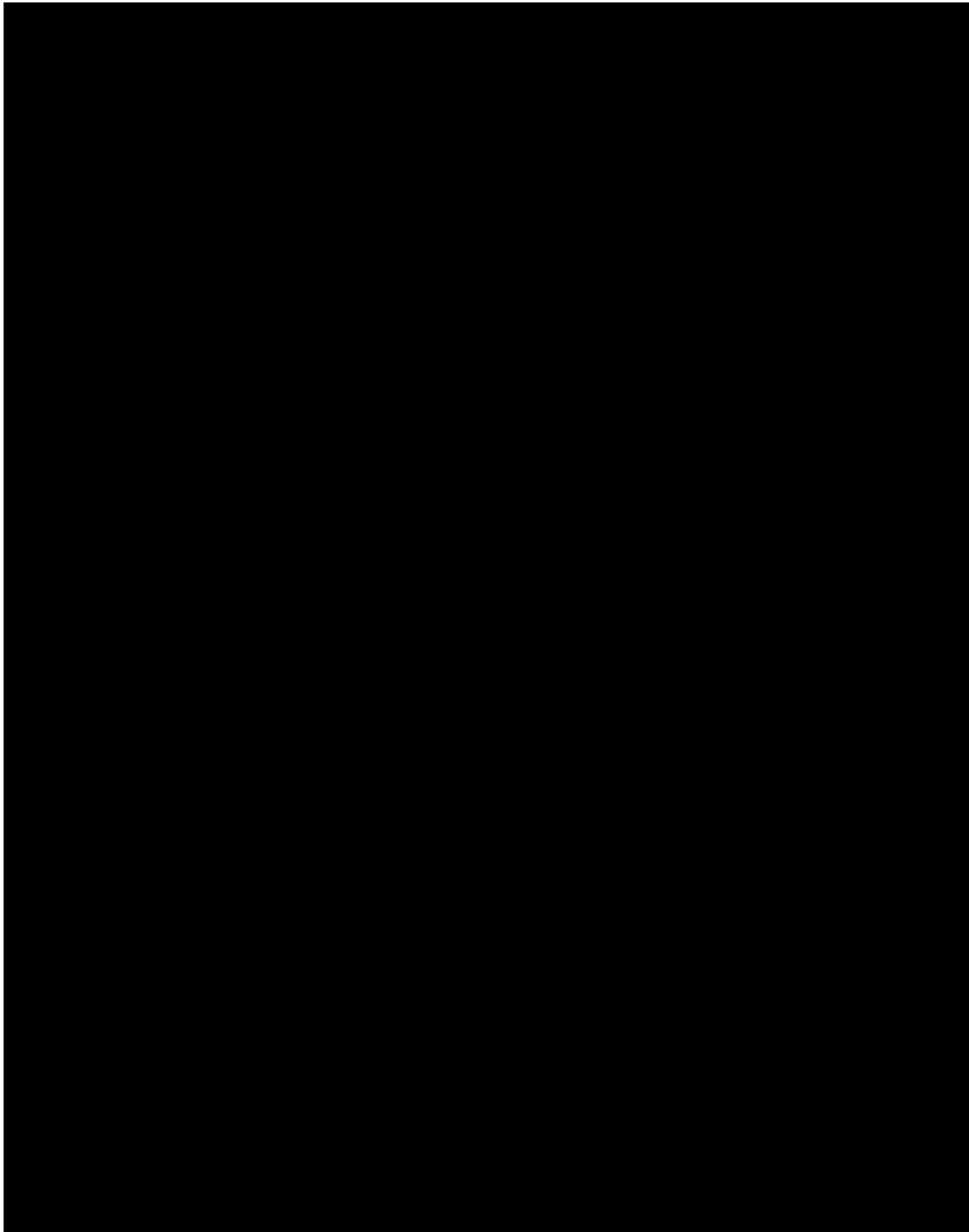



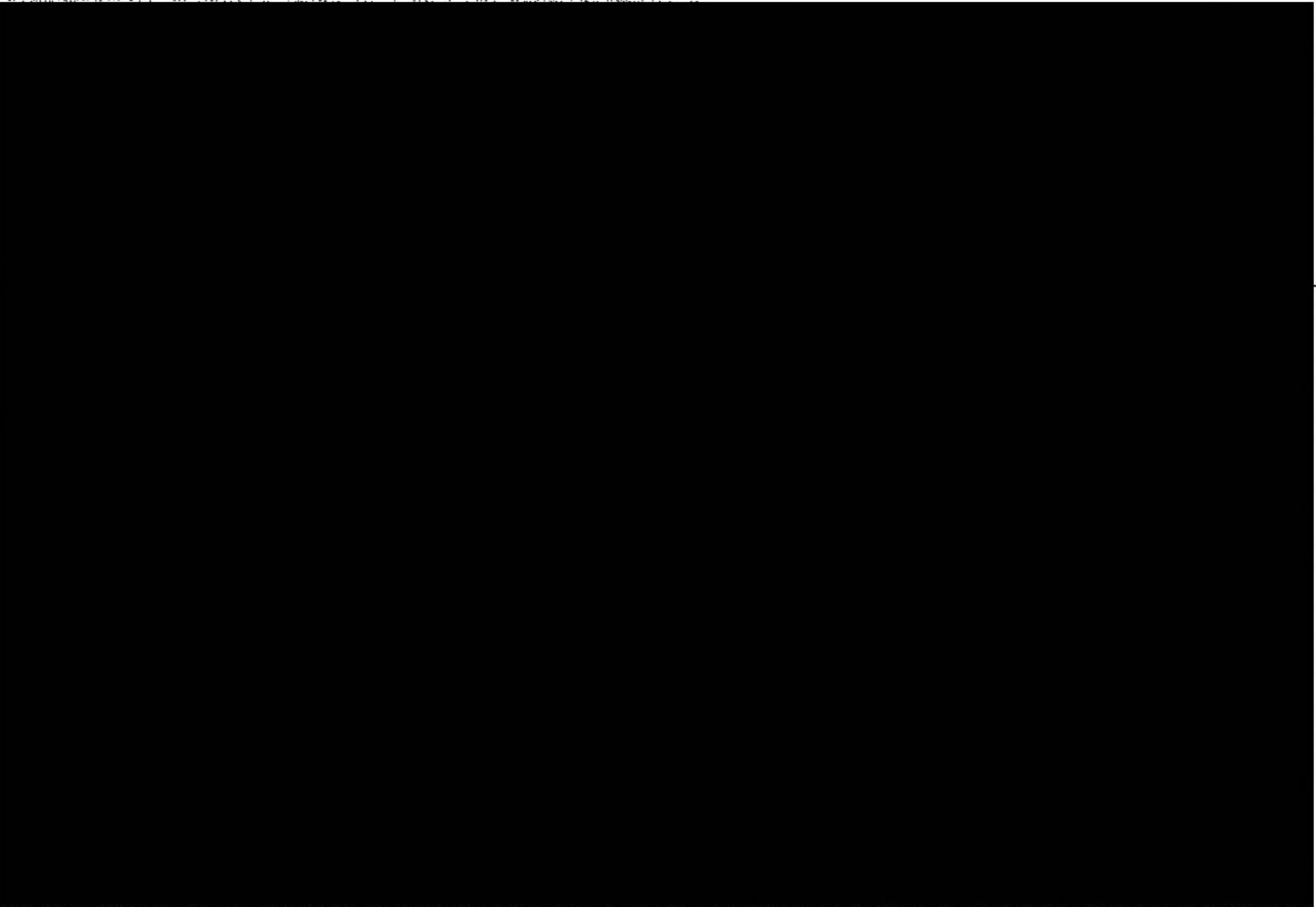

Attachments

I A D

Large Medium Small

Delete

Fees

Restart

Exit

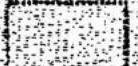

Save

**OXNARD POLICE DEPARTMENT
NARCOTICS ARREST REPORT**

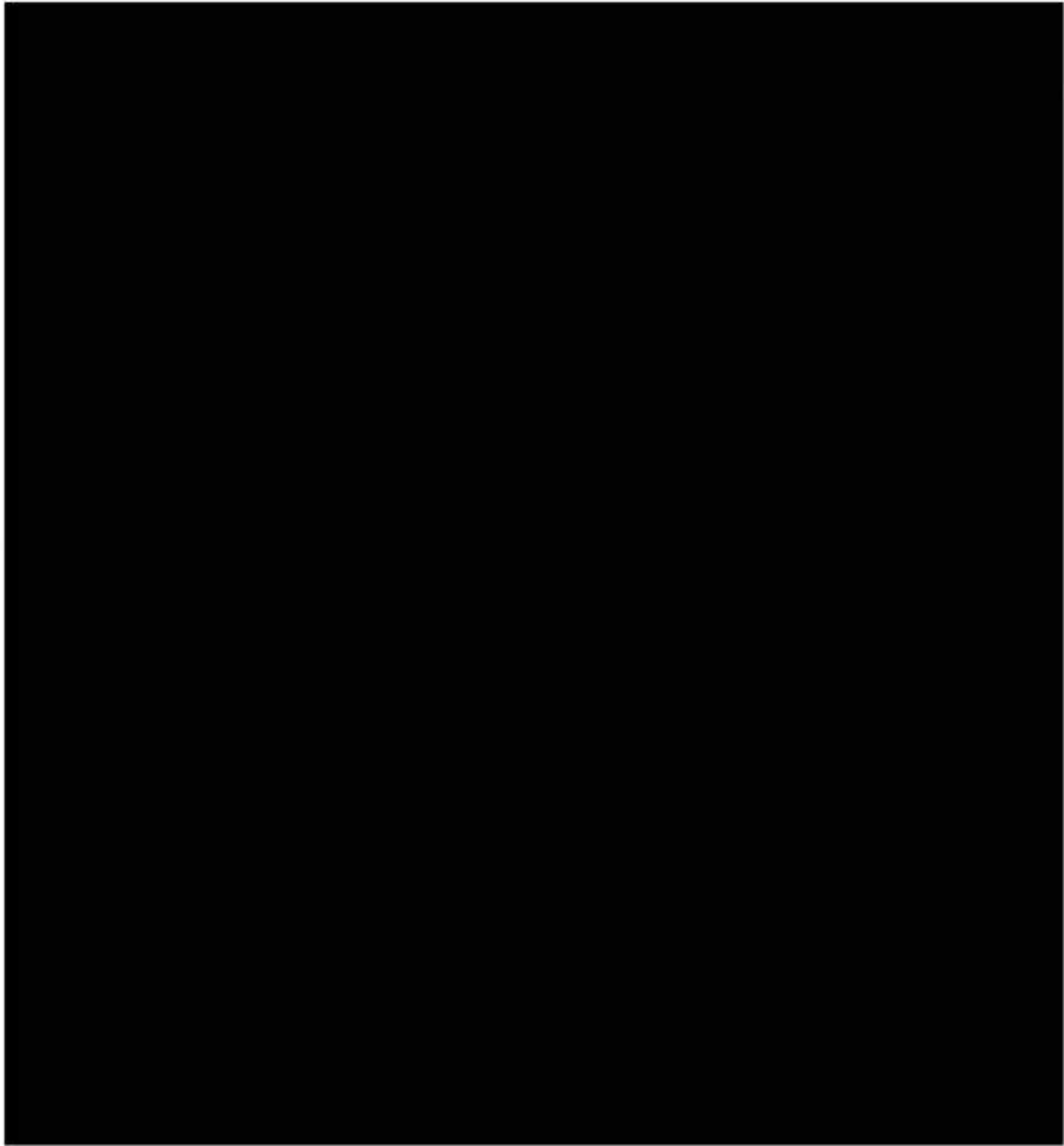

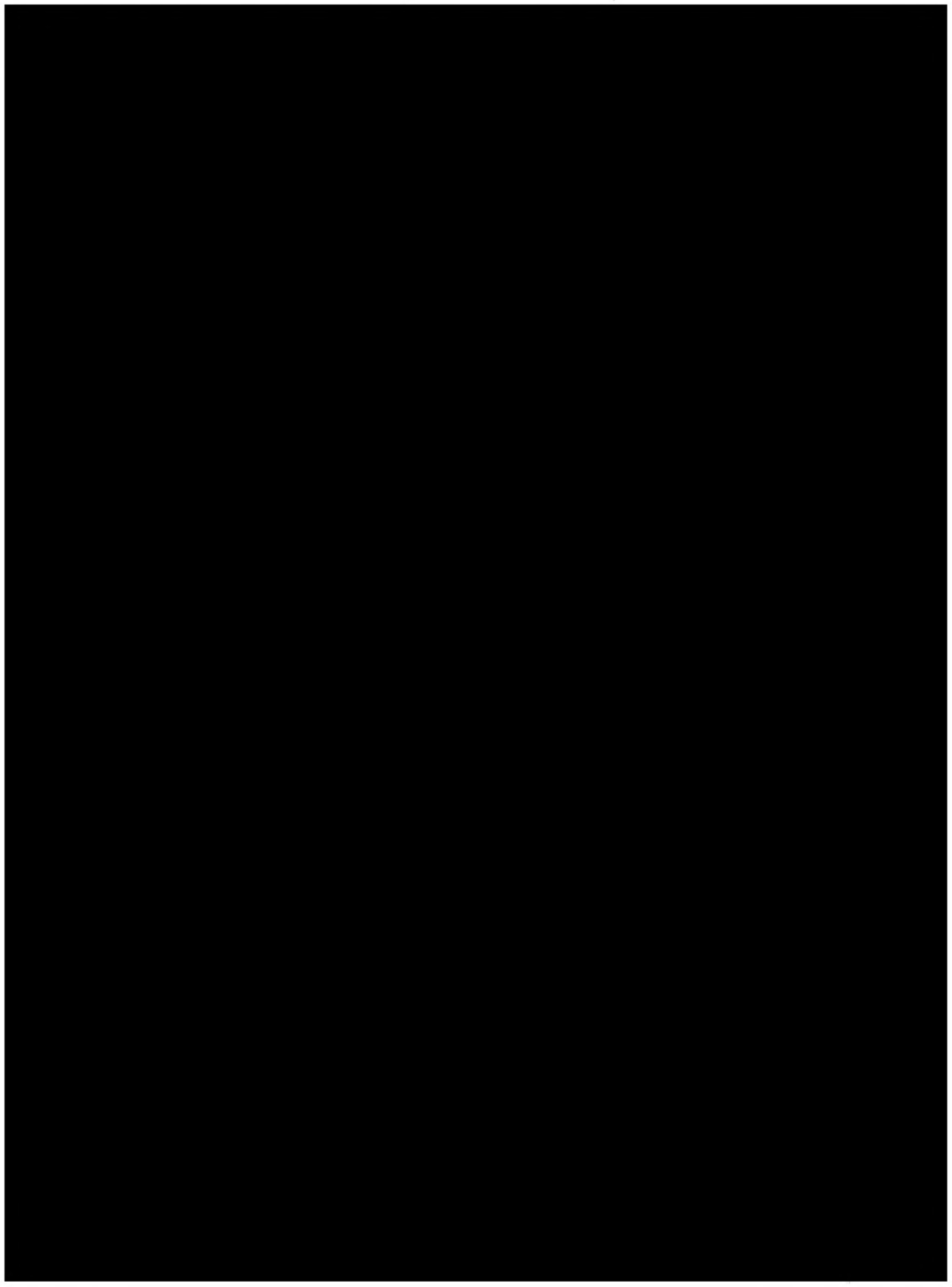

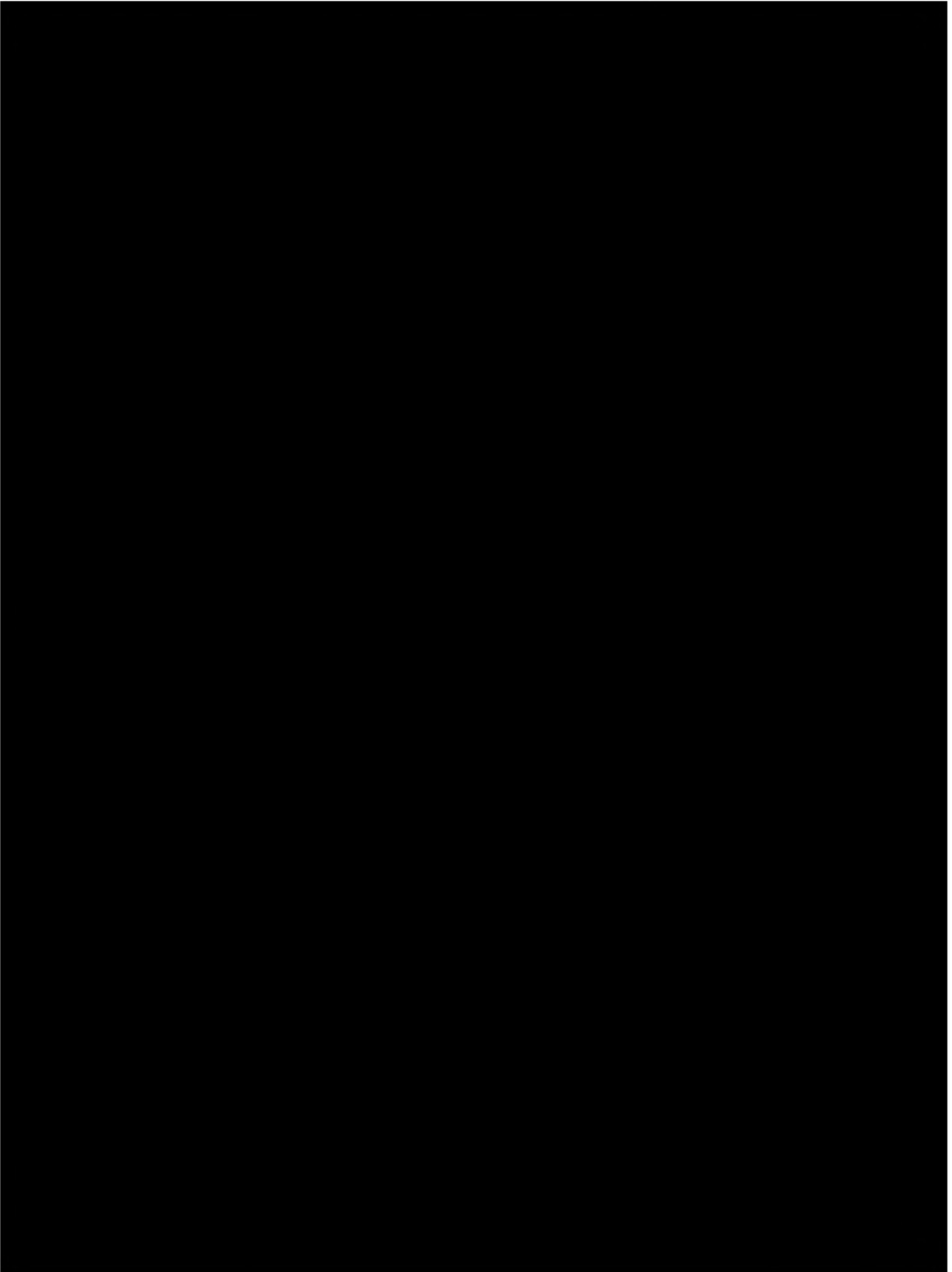

000000



SANTA PAULA POLICE DEPARTMENT

214 SOUTH 10TH STREET
SANTA PAULA, CALIFORNIA 93060
Phone (805) 933-4230
Fax (805) 525-0678

SM0602119

Case Number

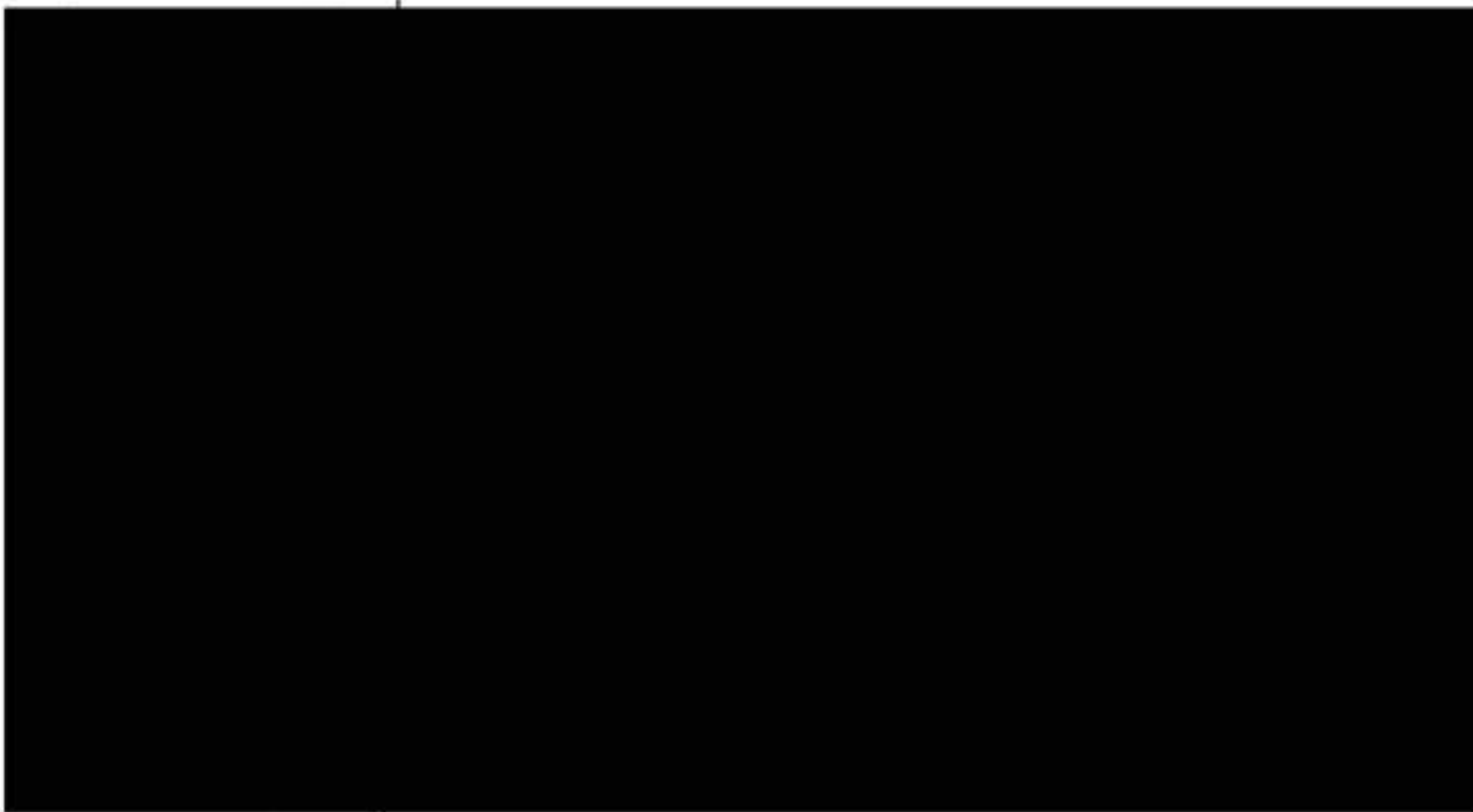

Released By: _____ Received By: _____ Date: _____

11/15/2006 5:09:25PM
Print Date/Time

SANTA PAULA POLICE DEPARTMENT

214 SOUTH 10TH STREET
SANTA PAULA, CALIFORNIA 93060
Phone (805) 933-4230
Fax (805) 525-0678

SM0602119

Case Number

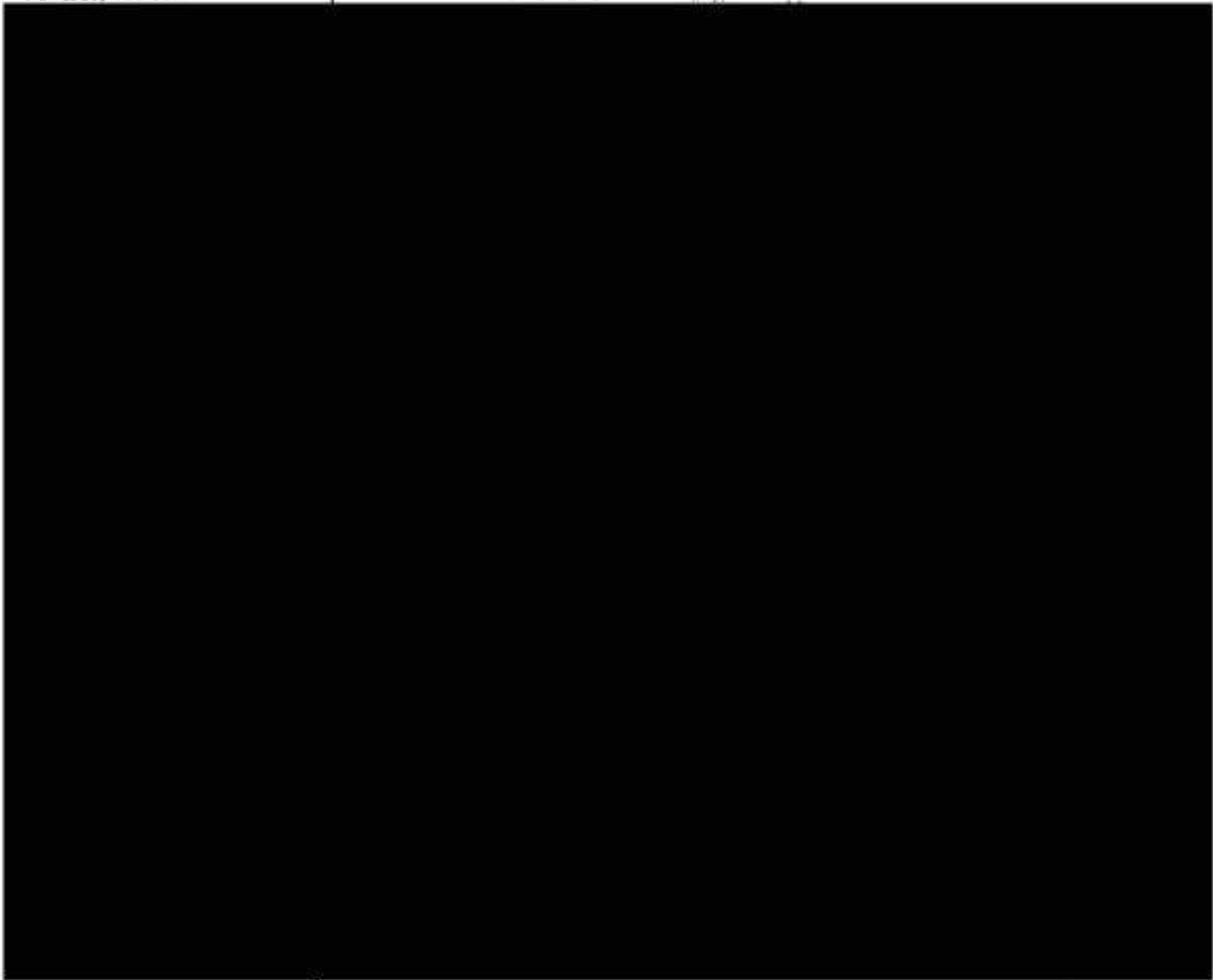

Released By: _____ Received By: _____ Date: _____

11/15/2008 5:03:25PM
Print Date/Time

SANTA PAULA POLICE DEPARTMENT

214 SOUTH 10TH STREET
SANTA PAULA, CALIFORNIA 93080
Phone (805) 933-4230
Fax (805) 525-0678

SM0602119

Case Number

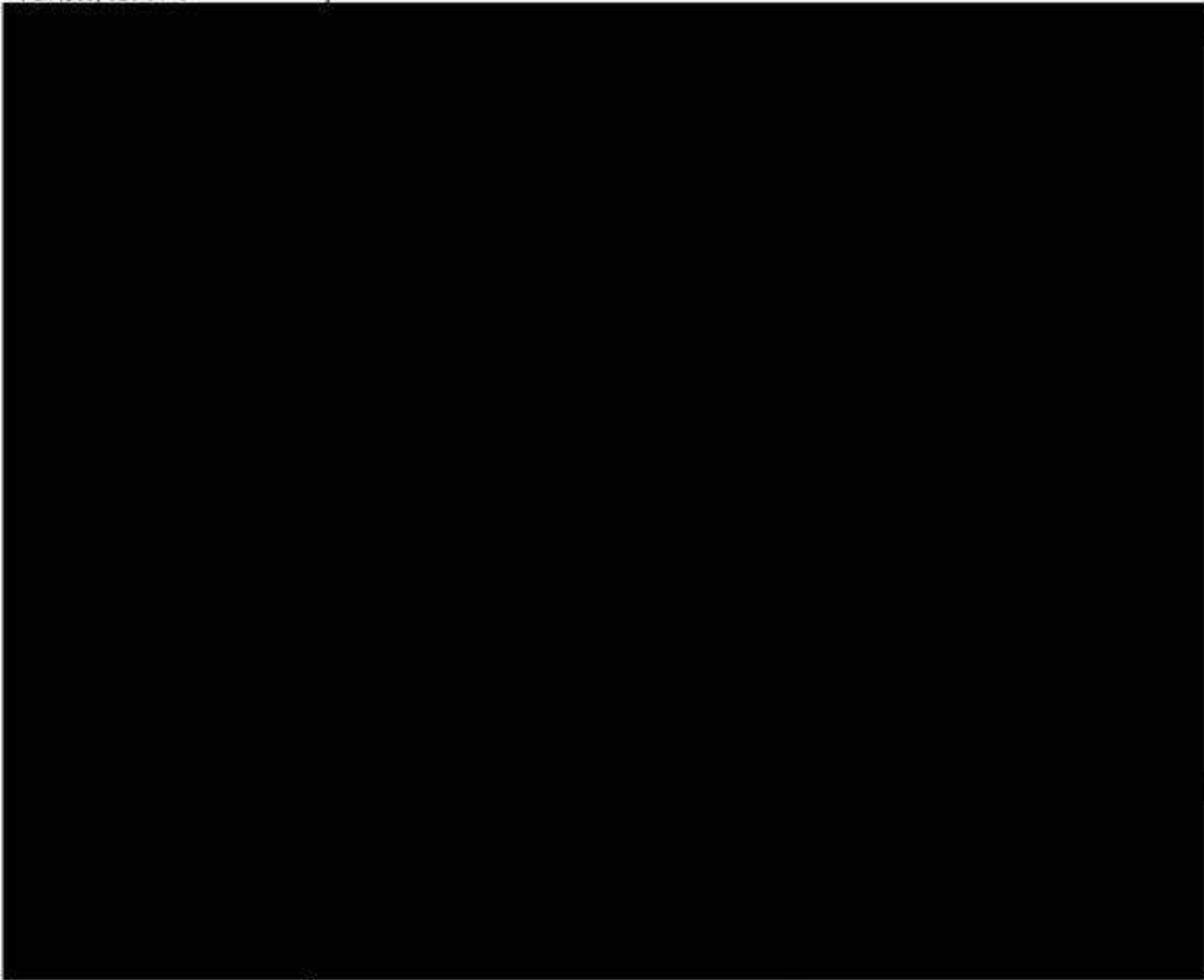

Released By: _____

Received By: _____

Date: _____

11/15/2008 5:03:25PM
Print Date/Time

Controlled Document, Duplication of Re-issuance Controlled by Law.

Page No. 3 Of 4

SANTA PAULA POLICE DEPARTMENT

214 SOUTH 10TH STREET
 SANTA PAULA, CALIFORNIA 93060
 Phone (805) 933-4230
 Fax (805) 525-0678

SM0602119

Case Number

INVESTIGATION	EVIDENCE OBTAINED	SOLVABILITY
<p><input type="checkbox"/> N = Dusted For Latents <input type="checkbox"/> N = Tool Marks Noted <input type="checkbox"/> N = Vehicle / Shoe Tracks <input type="checkbox"/> N = Photo Impressions Taken <input type="checkbox"/> N = Scene Photographed <input type="checkbox"/> N = Photo(s) Of Victim Taken <input type="checkbox"/> N = Diagram Of Scene <input type="checkbox"/> N = Neighbors Contacted <input type="checkbox"/> Y = Area Checked <input type="checkbox"/> N = Witnesses Contacted <input type="checkbox"/> Y = Victim Contacted <input type="checkbox"/> N = Other (See Narrative)</p>	<p><input type="checkbox"/> N = Finger Prints <input type="checkbox"/> N = Other Prints <input type="checkbox"/> Y = Weapon / Tools <input type="checkbox"/> N = Vehicle <input type="checkbox"/> N = Photos <input type="checkbox"/> N = Hair <input type="checkbox"/> N = Stains <input type="checkbox"/> N = Blood / Semen <input type="checkbox"/> N = Other (See Narrative) <input type="checkbox"/> N = None</p> <p style="text-align: center;">Approval APPROVED</p>	<p><input type="checkbox"/> Y = Was Suspect Arrested <input type="checkbox"/> Y = Can Suspect Be Named <input type="checkbox"/> Y = Can Suspect Be Located <input type="checkbox"/> Y = Can Suspect Be Ident. <input type="checkbox"/> Y = Witness To Crime <input type="checkbox"/> Y = Significant M.O. Present <input type="checkbox"/> Y = Property Traceable <input type="checkbox"/> Y = Significant Evidence <input type="checkbox"/> Y = All Elements Present <input type="checkbox"/> N = Major Injury or Rape <input type="checkbox"/> Y = Can Suspect be Described <input type="checkbox"/> Y = Can Suspect Vehicle be ID <input type="checkbox"/> Y = Is There Significant Reason to Believe Crime Can be Solved</p>

Copies To
 DA

Signature Verifying Original Copy of Case: _____ Date: _____
 Released By: _____ Received By: _____ Date: _____

SANTA PAULA POLICE DEPARTMENT

214 South 10th Street
Santa Paula, CA 93060

CA0560600

Phone (805) 933-4230

Fax (805) 525-0678

Case Number
SM0602119

Date
06/22/06

Officer
HUERTA #1047

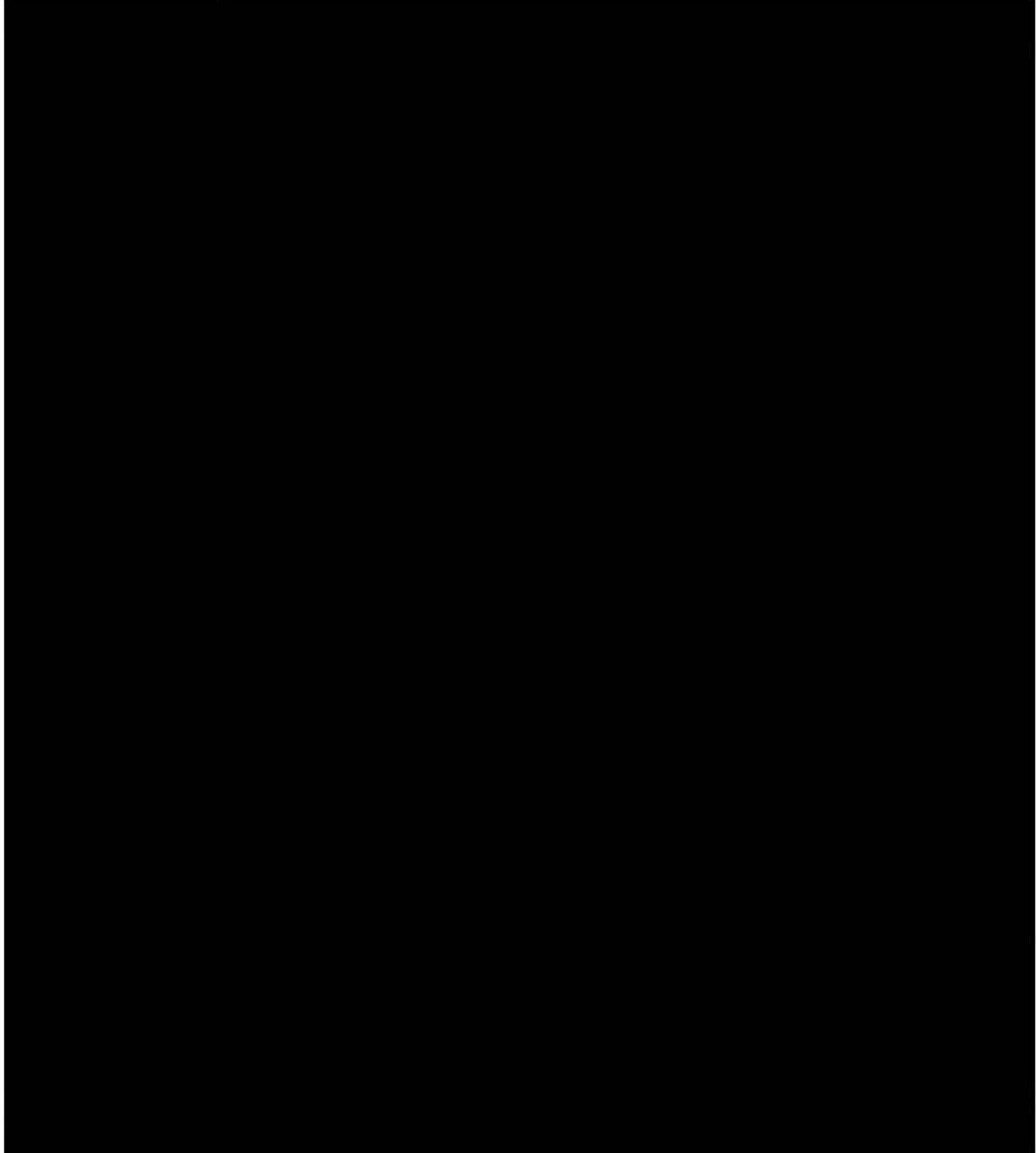

SANTA PAULA POLICE DEPARTMENT

214 South 10th Street
Santa Paula, CA 93060

CA0560600

Phone (805) 933-4230
Fax (805) 525-0678

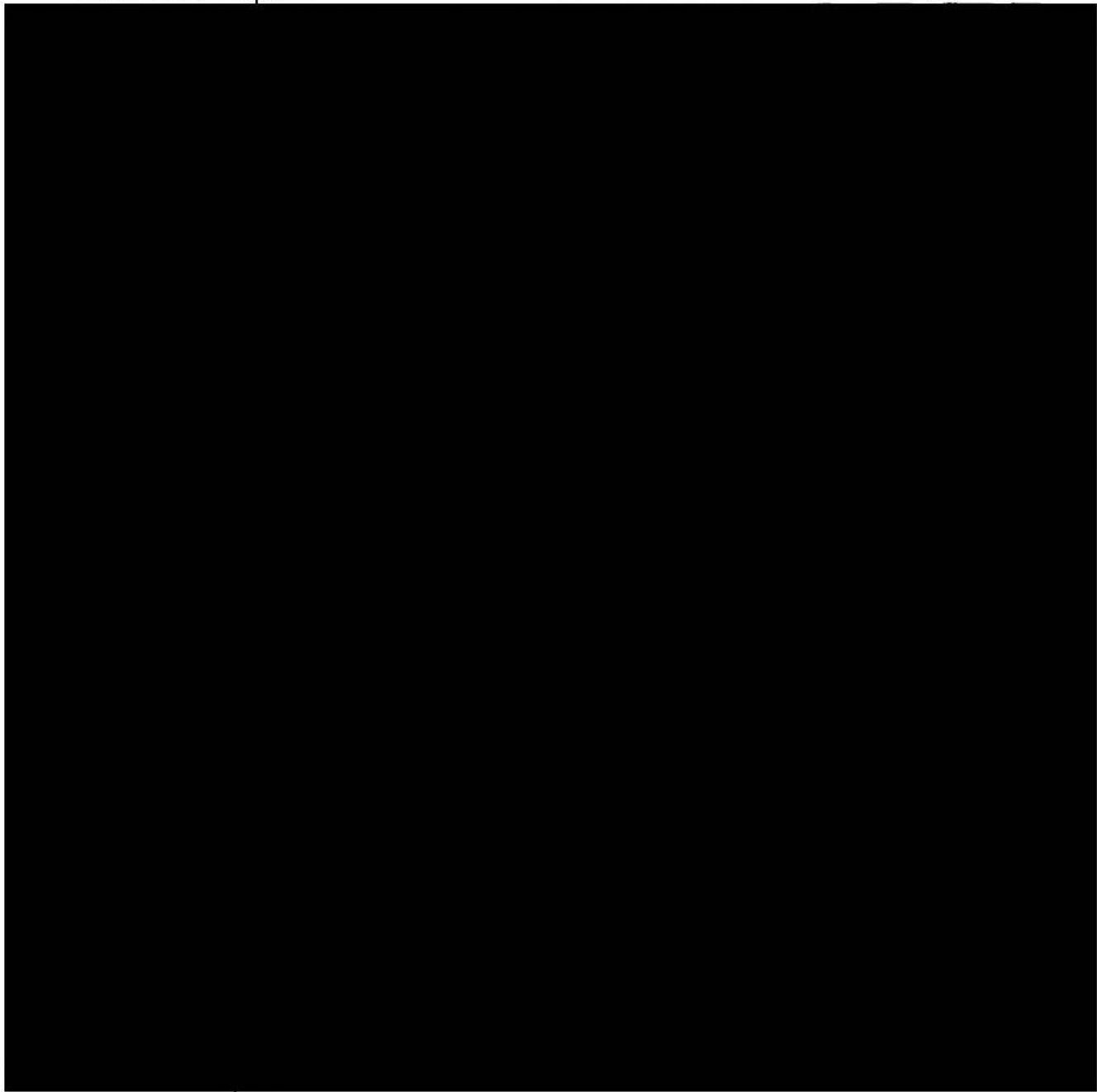

APPROVED BY:

DATE:

SANTA PAULA POLICE DEPARTMENT

214 South 10th Street
Santa Paula, CA 93060

CA0560600

Phone (805) 933-4230

Fax (805) 525-0678

Approved

06/22/2006 10:31 PM

SR. OFC. MADISON

SANTA PAULA POLICE DEPARTMENT
214 South 10th Street
Santa Paula, CA 93060

CA0580600
Phone (805) 933-4230
Fax (805) 525-0678

Supplement

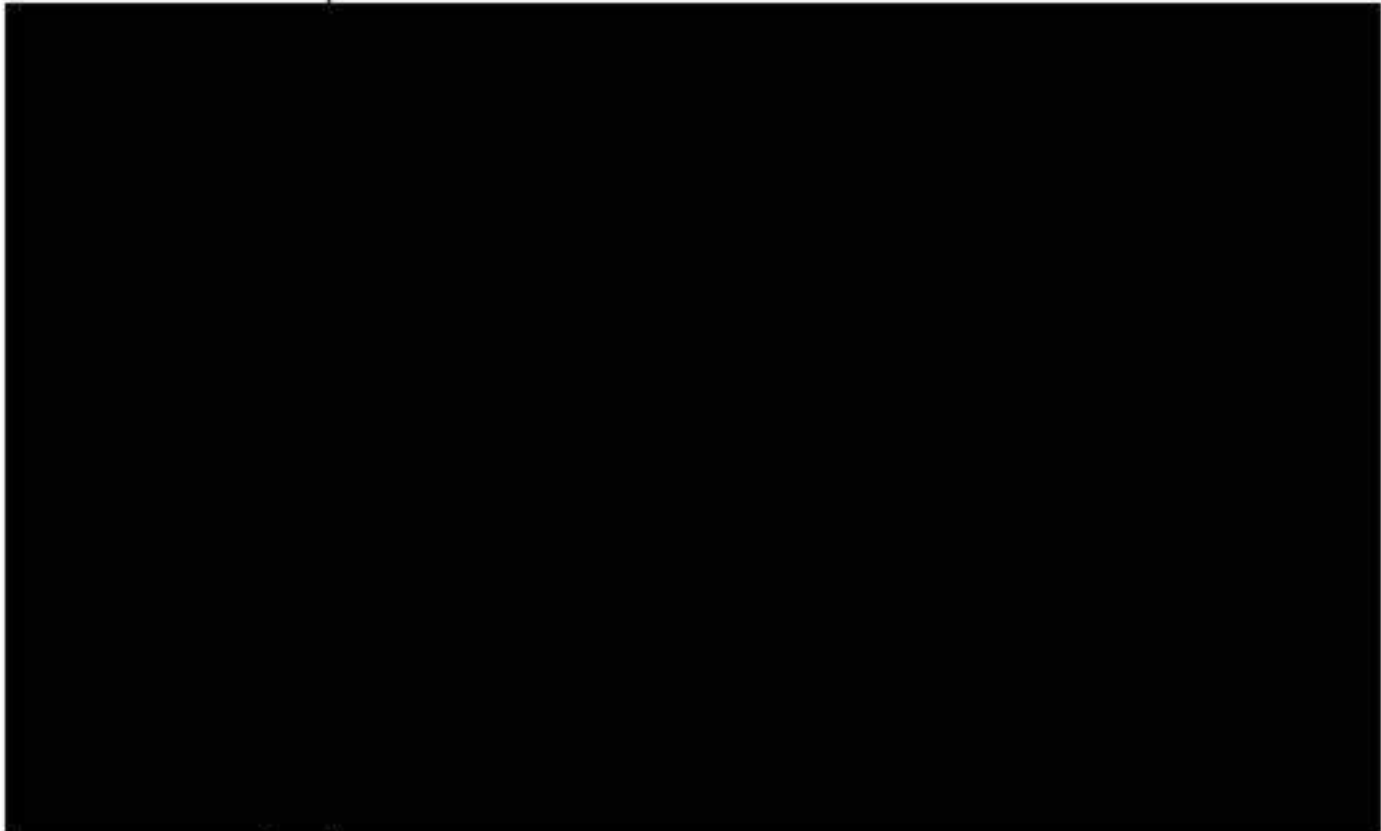

Approved
08/11/2006 01:51 AM
SGT. SAVIERS

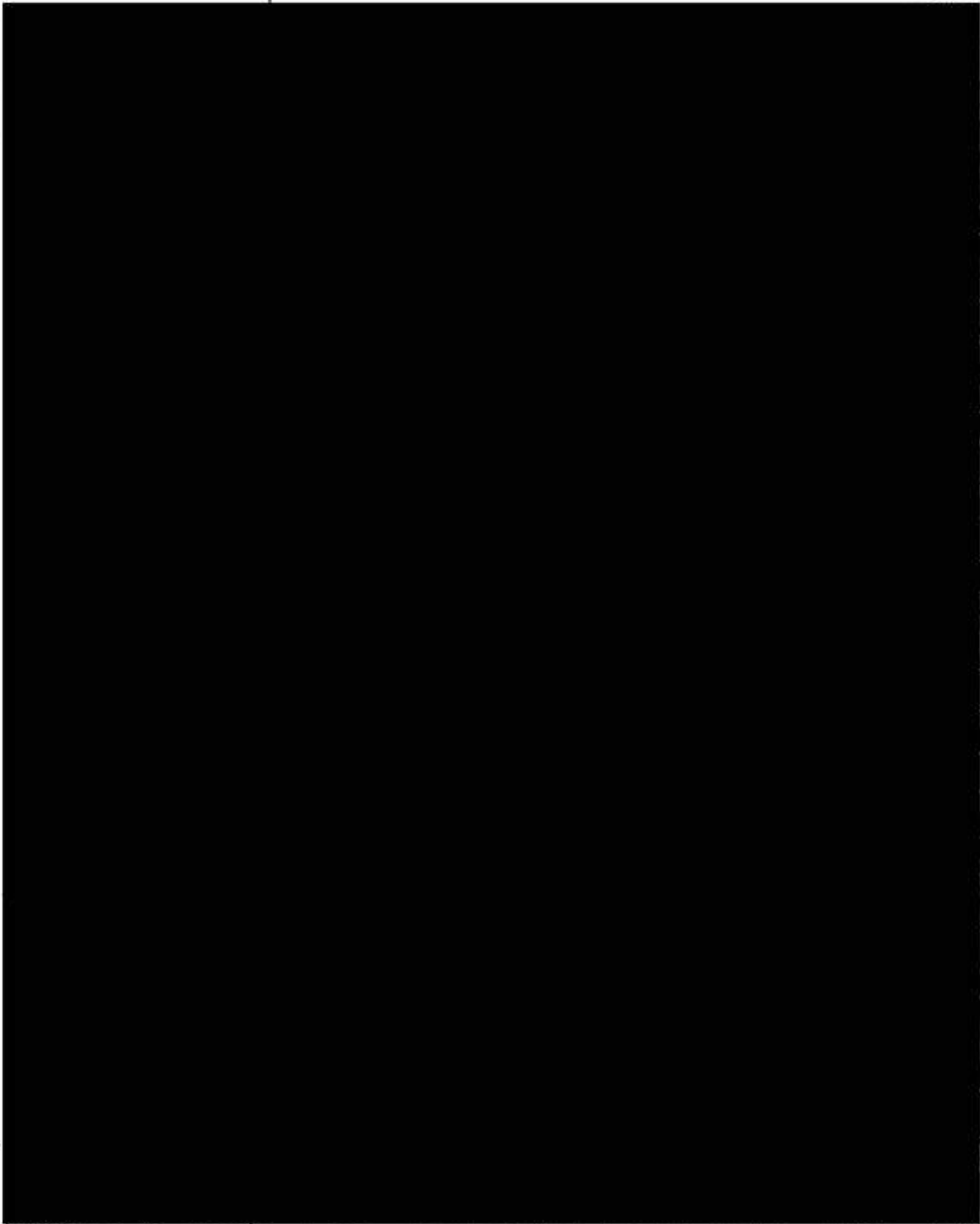

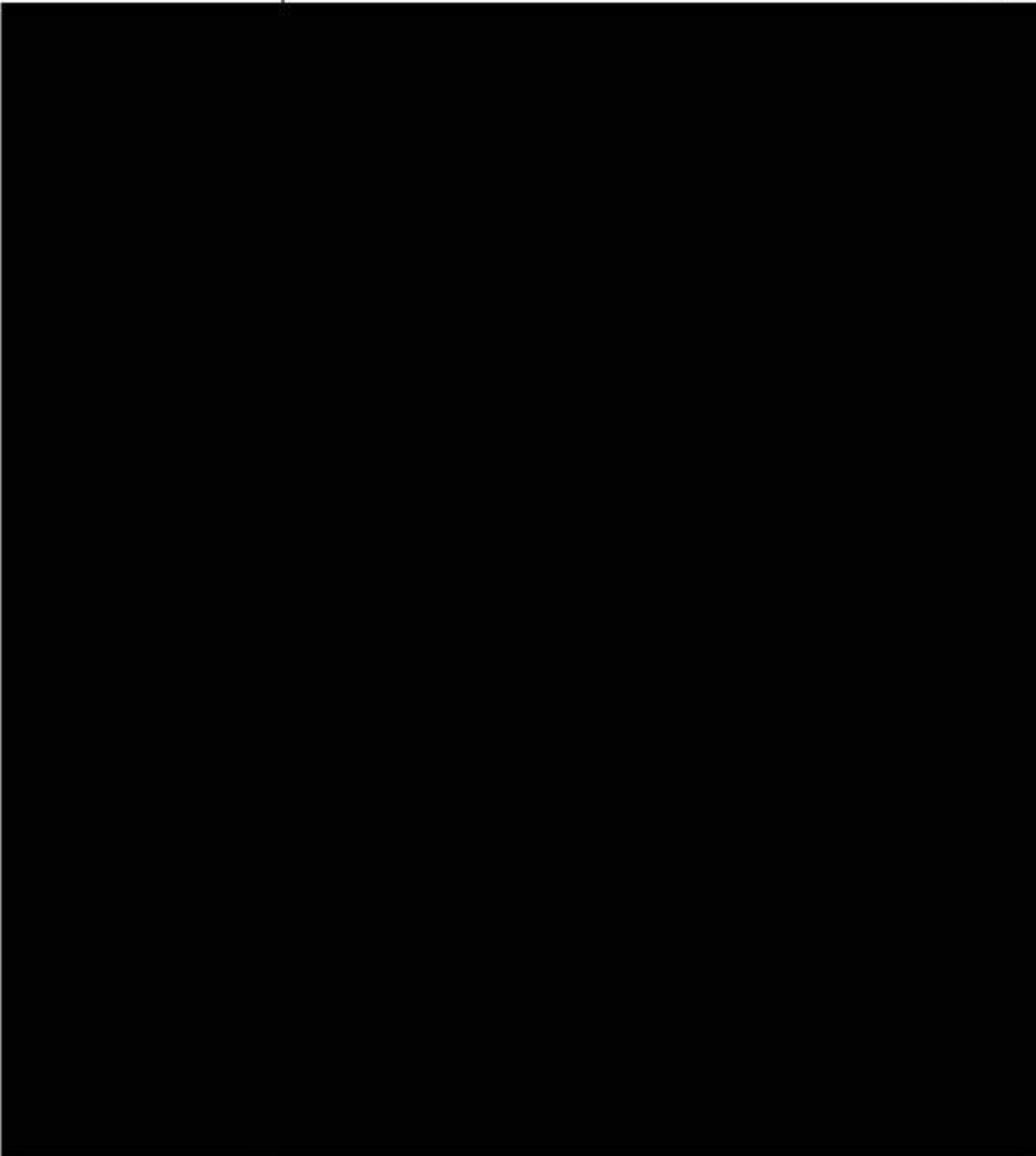

Narrative Date/Time
06/22/06 0115

Officer
HUERTA

Approval
SR OFC. MADISON

Approval Date
07/09/06

Print Date / Time
11/15/06 5:03:12PM

Booking Number
SJ0600643

Page No.
2

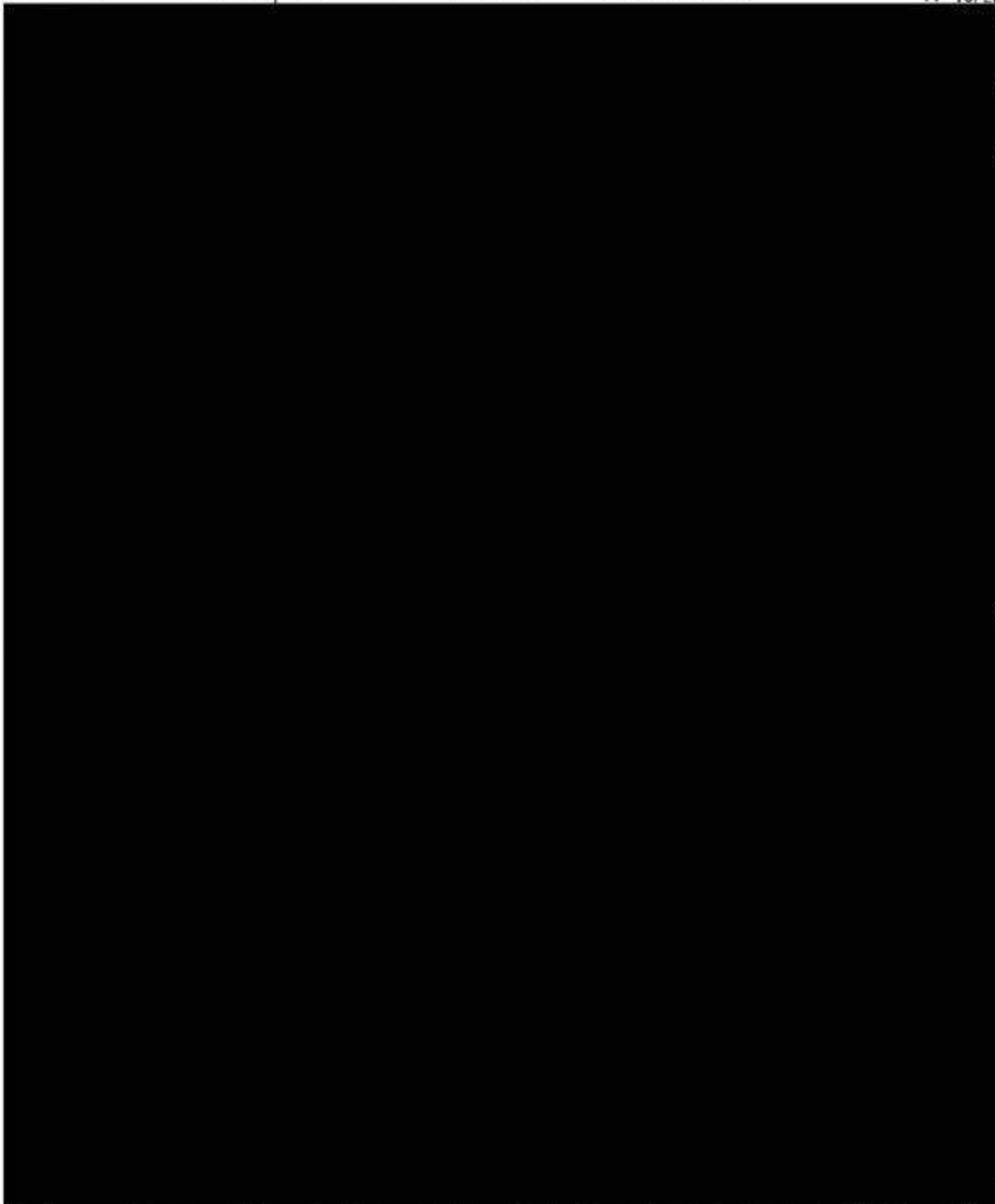

78

23

23

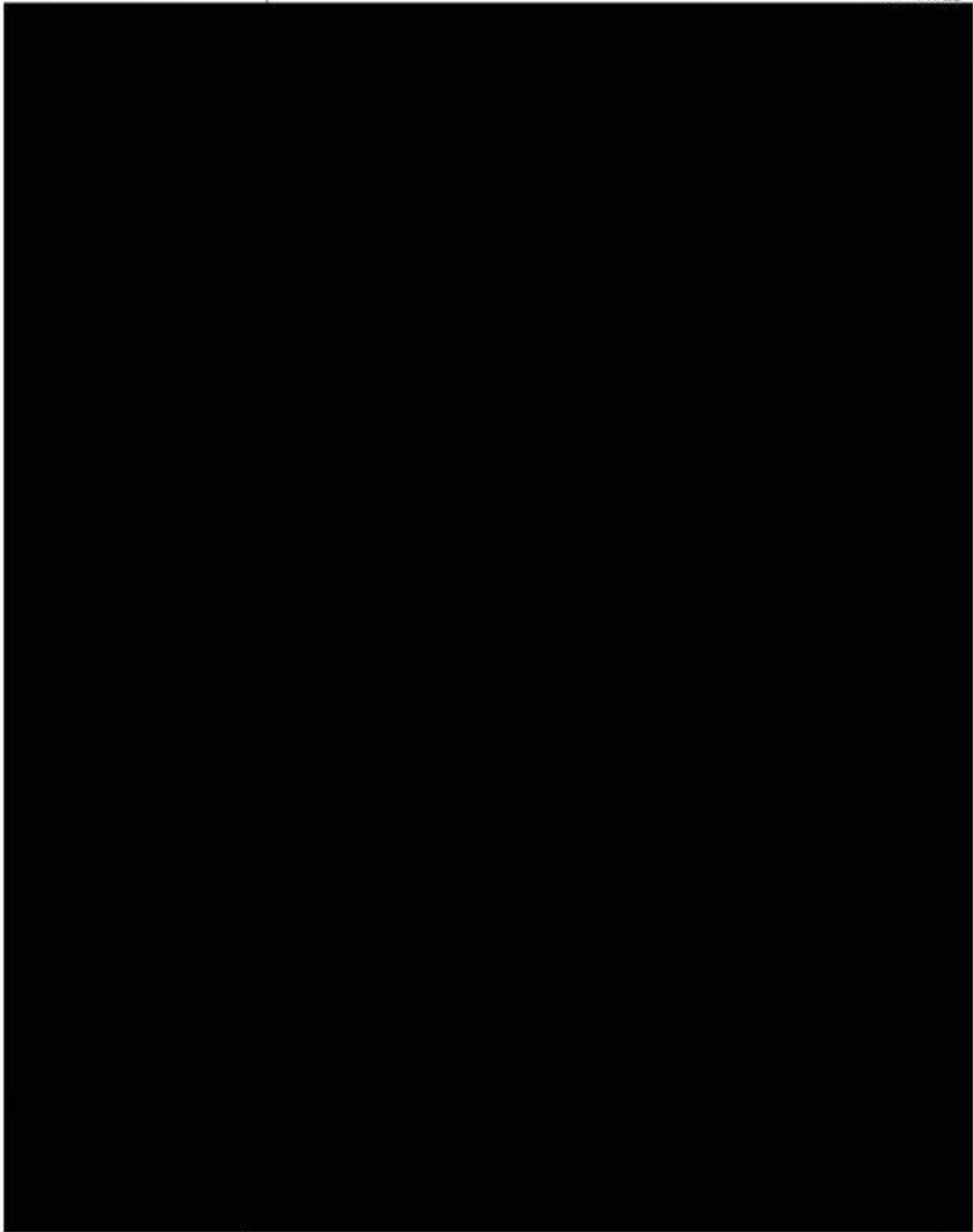

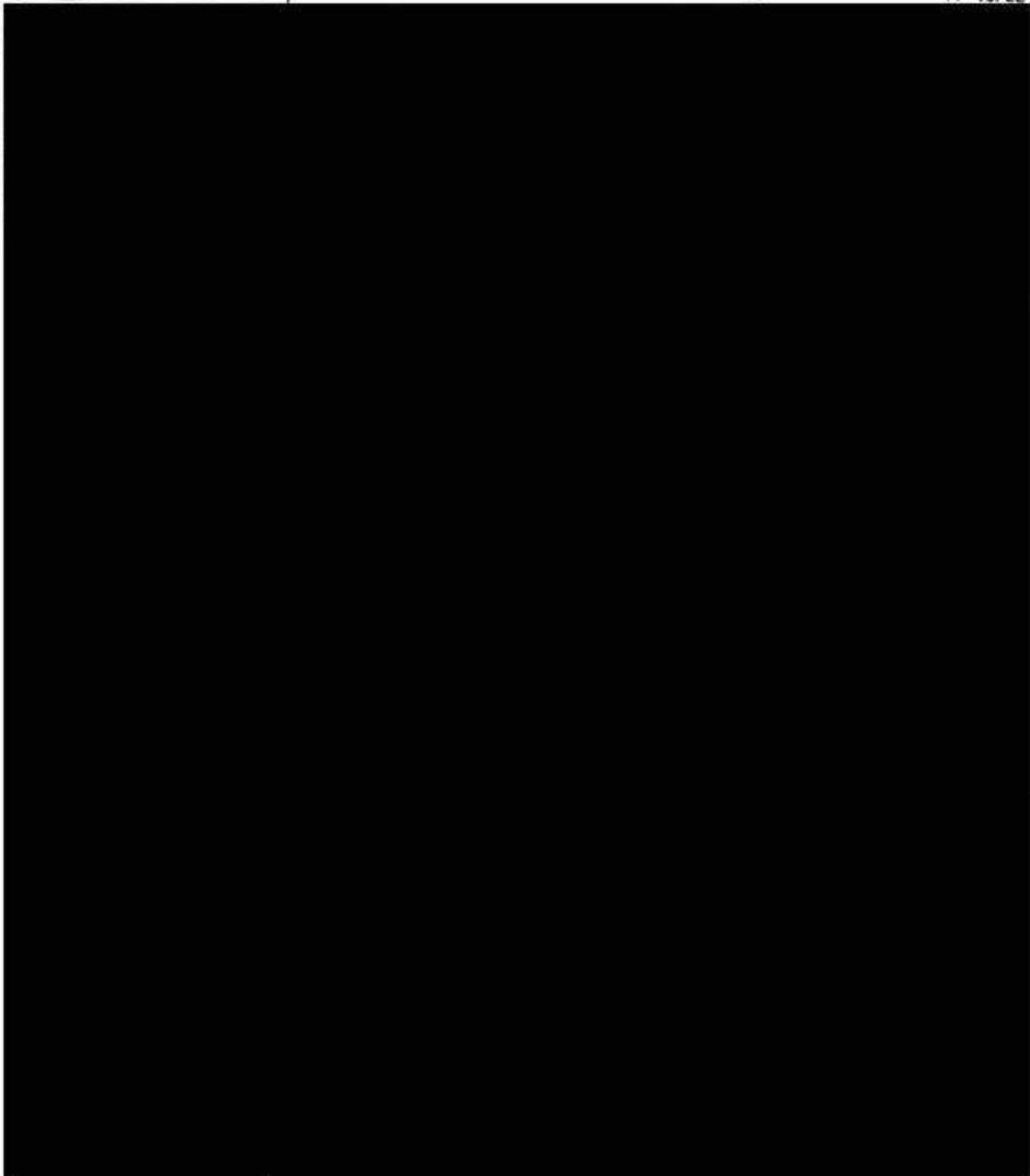

Narrative Date/Time
08/22/06 0115

Officer
HUERTA

Approval
GR. OFC. MADISON

Approval Date
07/09/06

Print Date / Time
11/15/06 5:07:58PM

Booking Number
SJC00643

Page No.
2

SANTA PAULA POLICE DEPARTMENT

214 SOUTH 10TH STREET

Phone (805) 933-4230

Fax (805) 525-0678

Arrestee's Name (Last, First Middle)
CANLEY, ADRIAN, DOYLE

Property Receipt

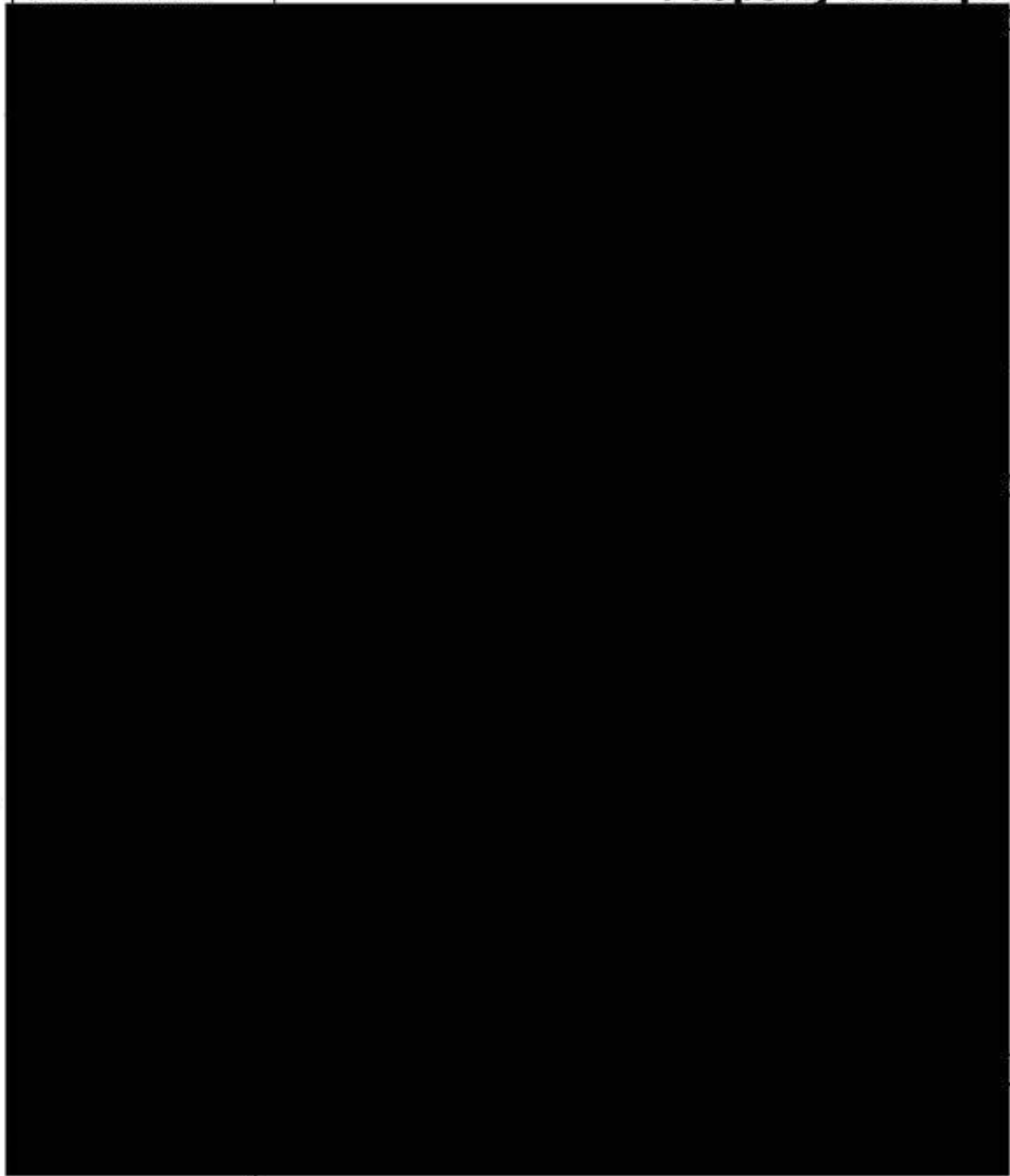

SANTA PAULA POLICE DEPARTMENT

214 South 10th Street
Santa Paula, CA 93060

CA0560600

Phone (805) 933-4230
Fax (805) 525-0678

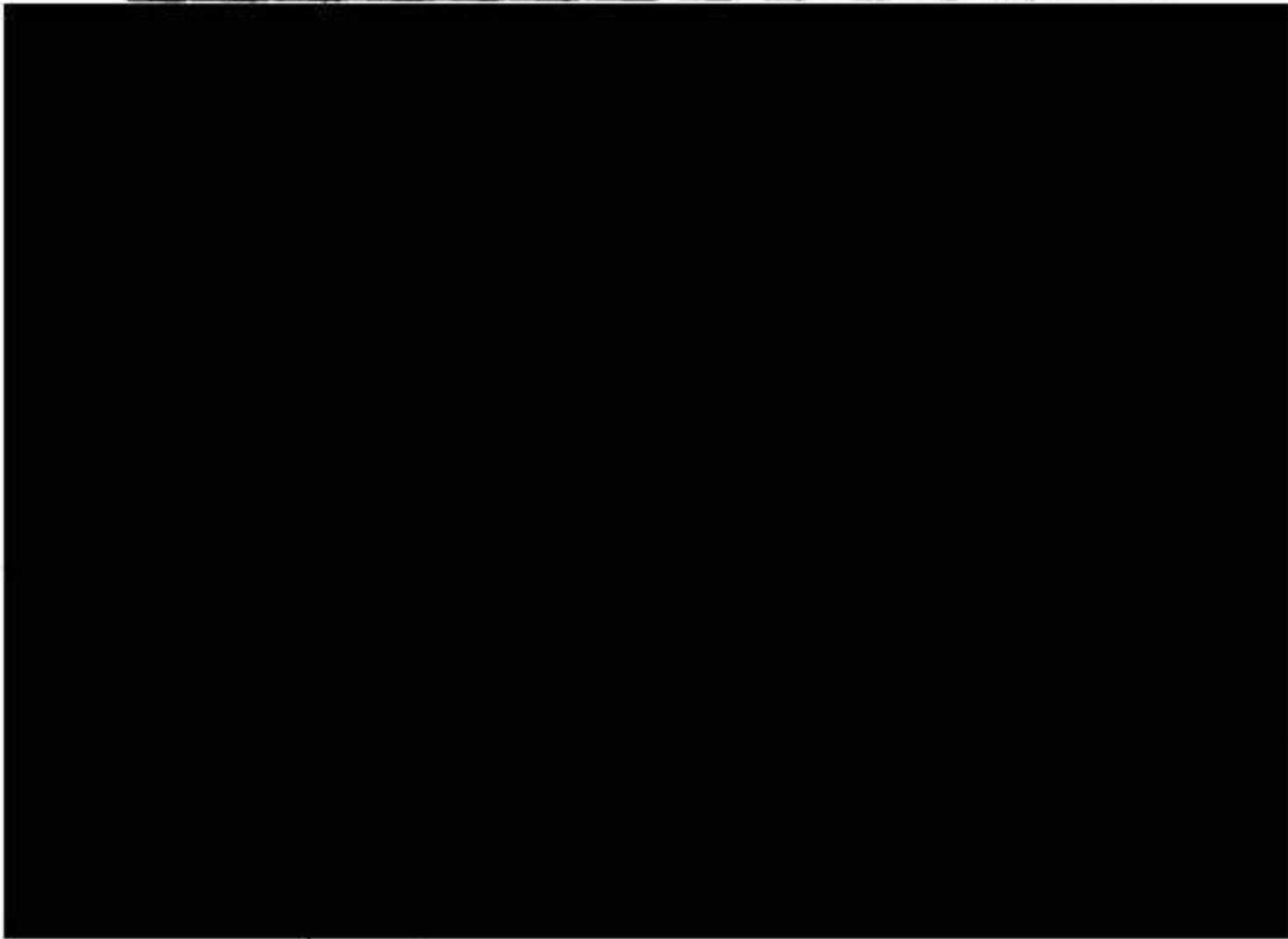

Existing Record for Update

Generic Alpha

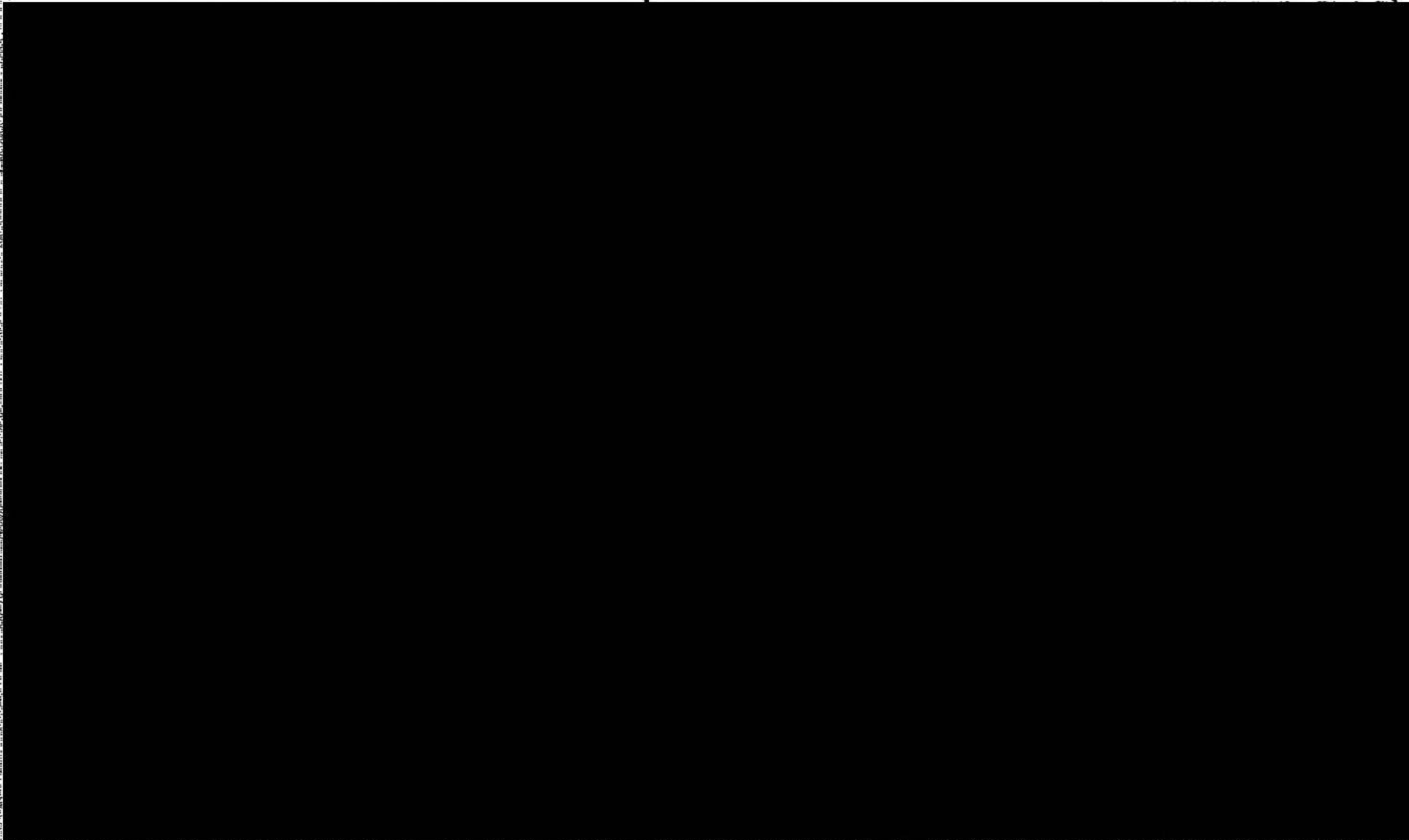

Save

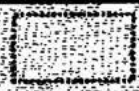

Exit

Restart

Delete

Eees

Images/
Indent

Live Scan



ARREST REPORT

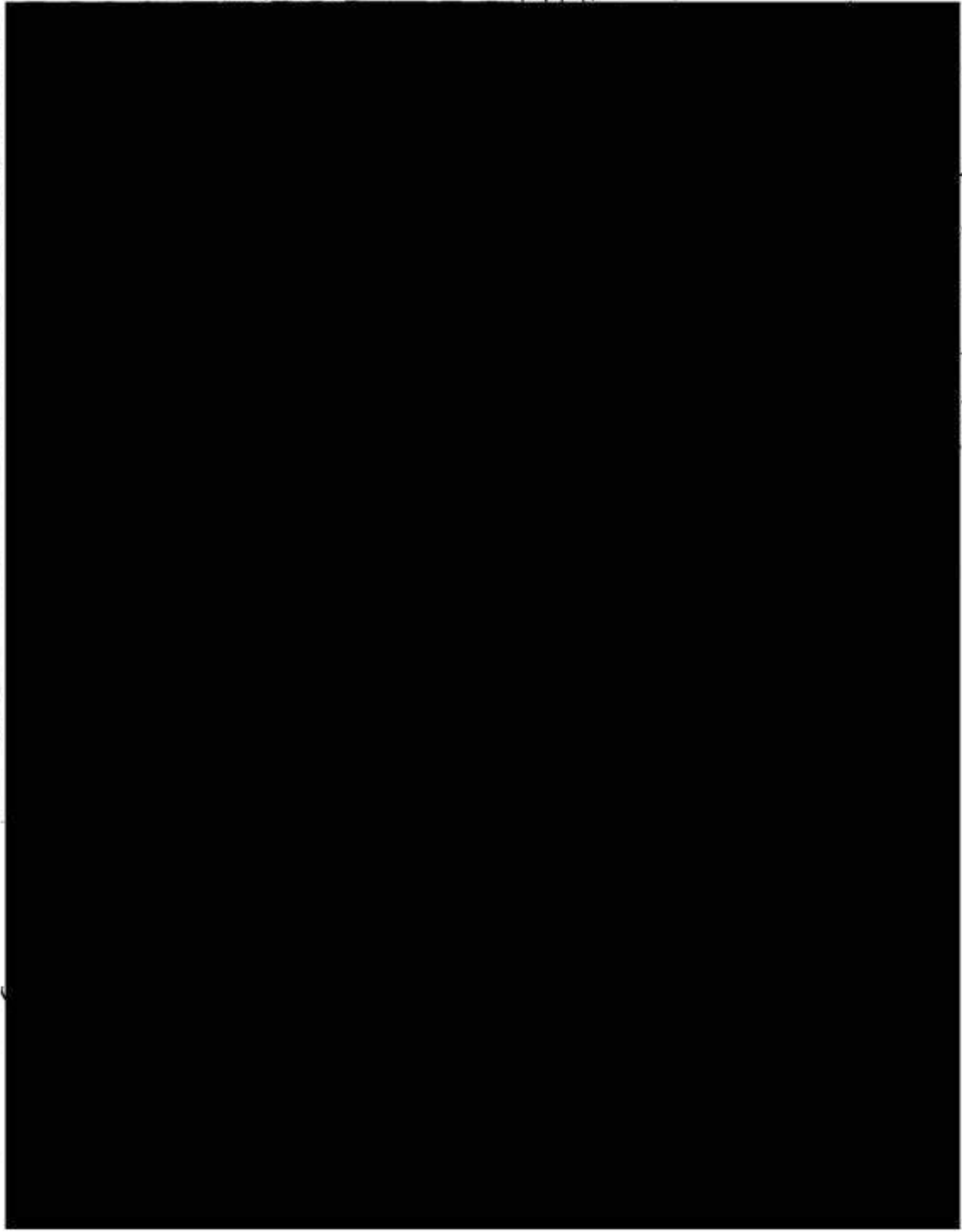

10/10/10 10:10 AM

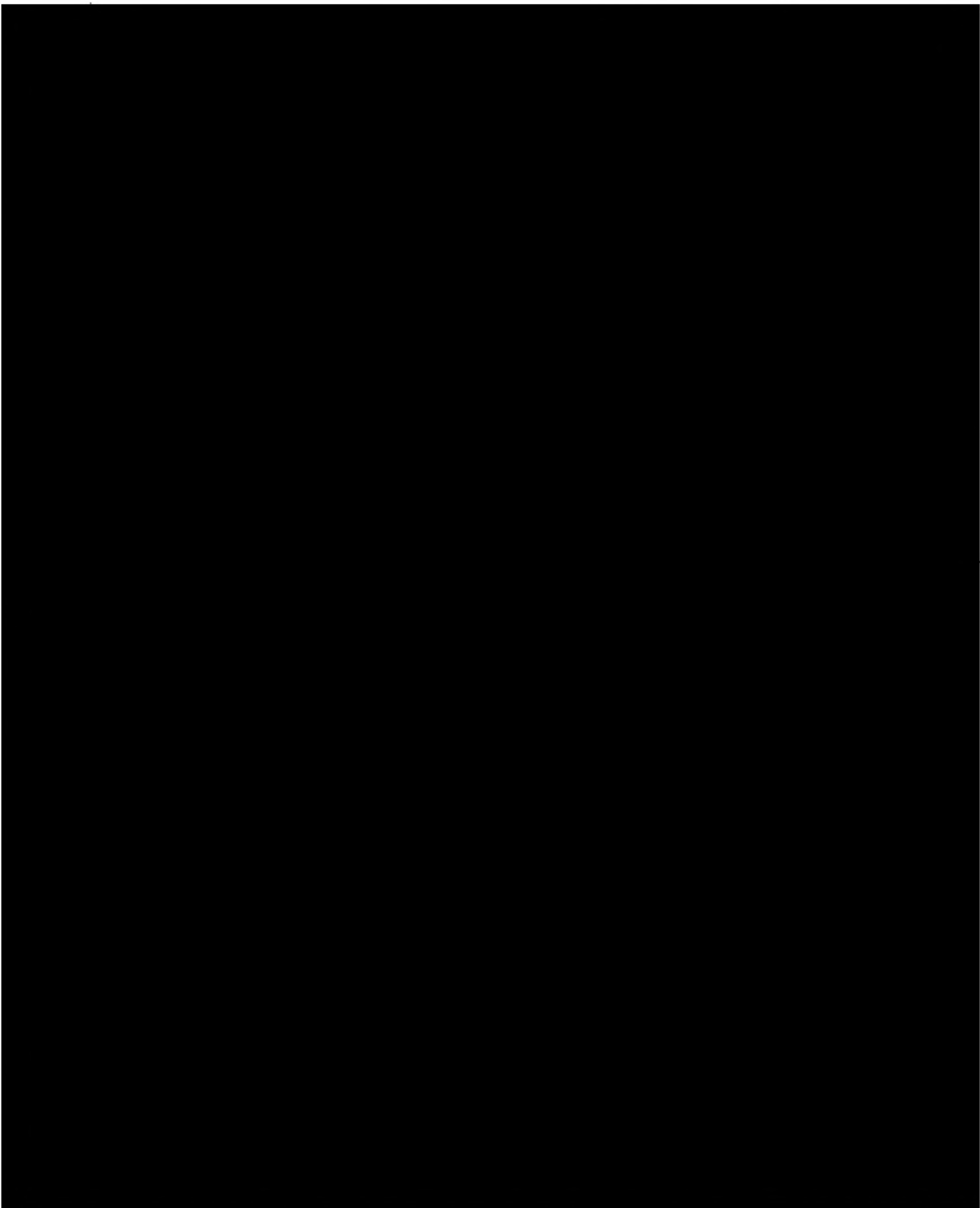

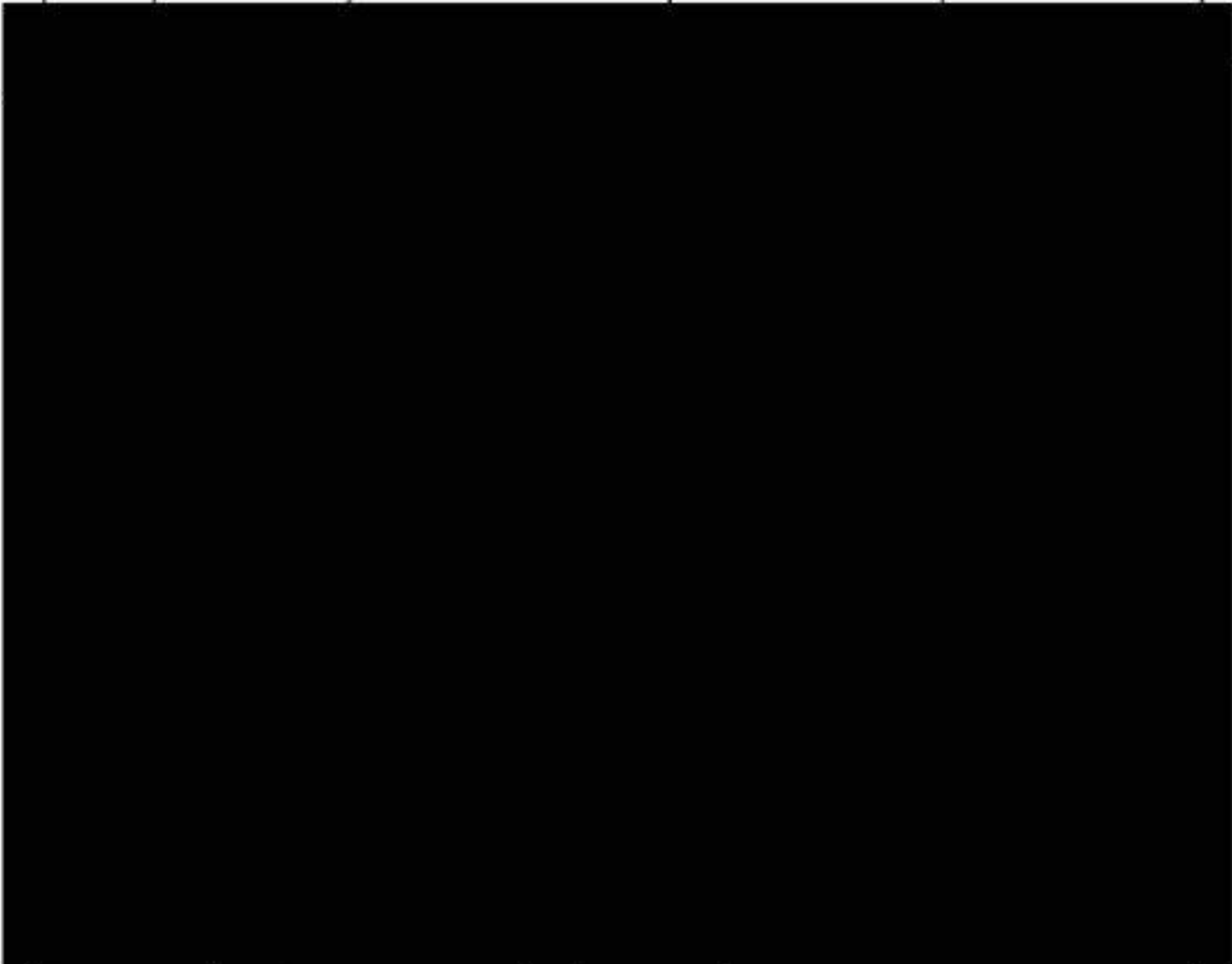

AN EMPLOYEE SEIZING OR TAKING CUSTODY OF PROPERTY SHALL ISSUE A RECEIPT FOR PROPERTY TAKEN INTO CUSTODY, FORM 10.10 (DUPLICATE COPY), TO THE PERSON RELIEVED OF THE PROPERTY (4/645.20, 5/10.10). THE ORIGINAL OF THE FORM 10.10 SHALL BE INCLUDED AS A PAGE OF THE ORIGINAL OF THE PROPERTY REPORT, FORM 10.1; NOTICE TO APPEAR/RELEASE FROM CUSTODY REPORT, FORM 5.2.8; OR ARREST REPORT, FORM 5.2, WHEN EVIDENCE IS LISTED THEREON.

RECEIPT FOR PROPERTY TAKEN INTO CUSTODY

* SAVE THIS RECEIPT *

AN EMPLOYEE SEIZING OR TAKING CUSTODY OF PROPERTY SHALL ISSUE A RECEIPT FOR PROPERTY TAKEN INTO CUSTODY, FORM 10.10 (DUPLICATE COPY), TO THE PERSON RELIEVED OF THE PROPERTY (4/645.20, 5/10.10). THE ORIGINAL OF THE FORM 10.10 SHALL BE INCLUDED AS A PAGE OF THE ORIGINAL OF THE PROPERTY REPORT, FORM 10.1; NOTICE TO APPEAR/RELEASE FROM CUSTODY REPORT, FORM 5.2.8; OR ARREST REPORT, FORM 5.2, WHEN EVIDENCE IS LISTED THEREON.

<input type="checkbox"/> C & R	<input type="checkbox"/> EXONERATED	<input type="checkbox"/> CIV.	<input type="checkbox"/> JUV. TRAP. MISC.	<input type="checkbox"/> OCS	DATE / TIME DISPO. REPROD.	CR. / CLERK
<input type="checkbox"/> ACTION SUSP.	<input type="checkbox"/> REL. INSUR. EVID.	<input type="checkbox"/> PROBATION	<input type="checkbox"/> FIRE DEPT.	<input type="checkbox"/> OTHER		
<input type="checkbox"/> PROVED ADULT	<input type="checkbox"/> COMMUNITY SERVICE	<input type="checkbox"/> OTH. LAW ENF. AGENCY	<input type="checkbox"/> DEPT. MENTAL HEALTH			

ARREST REPORT

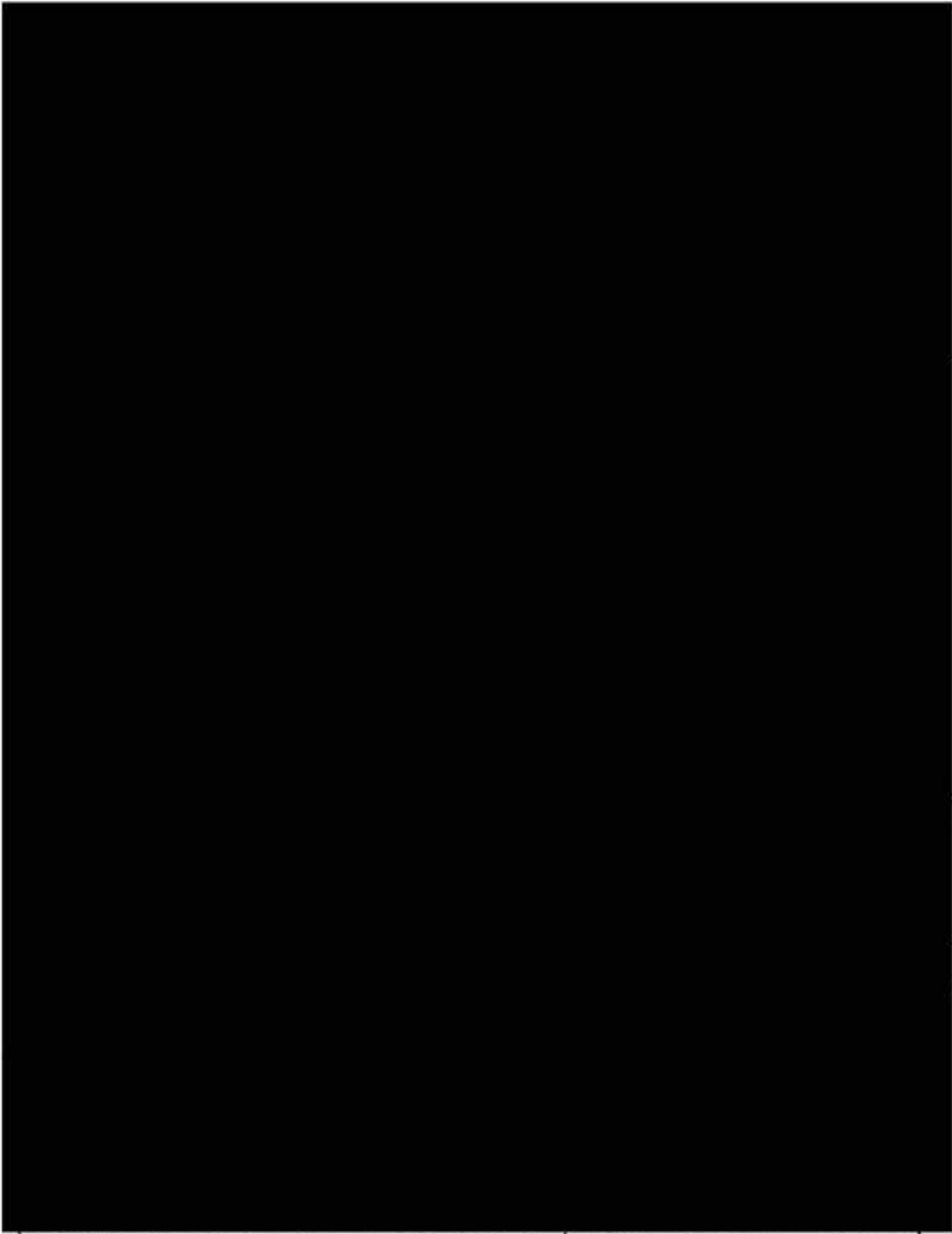

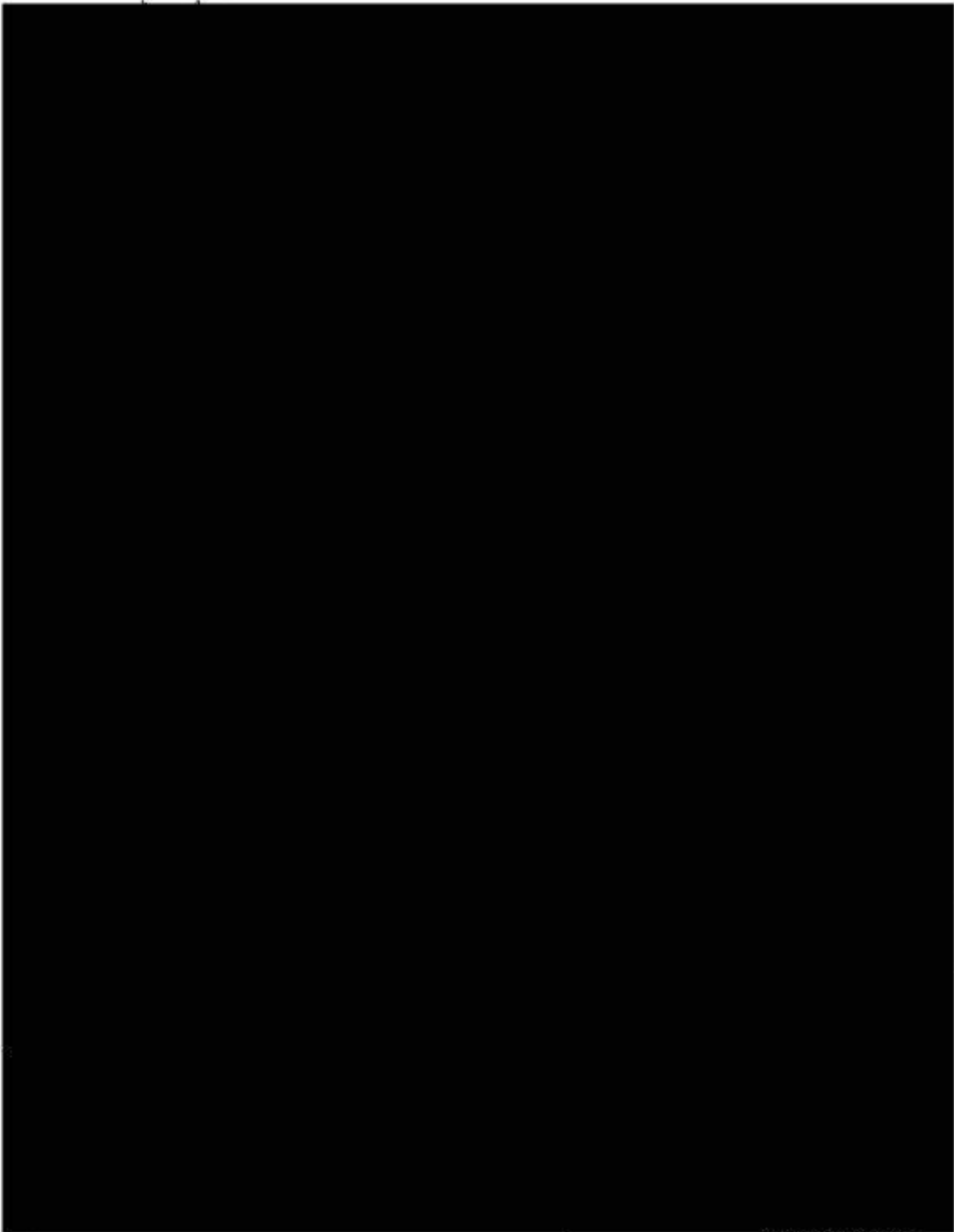

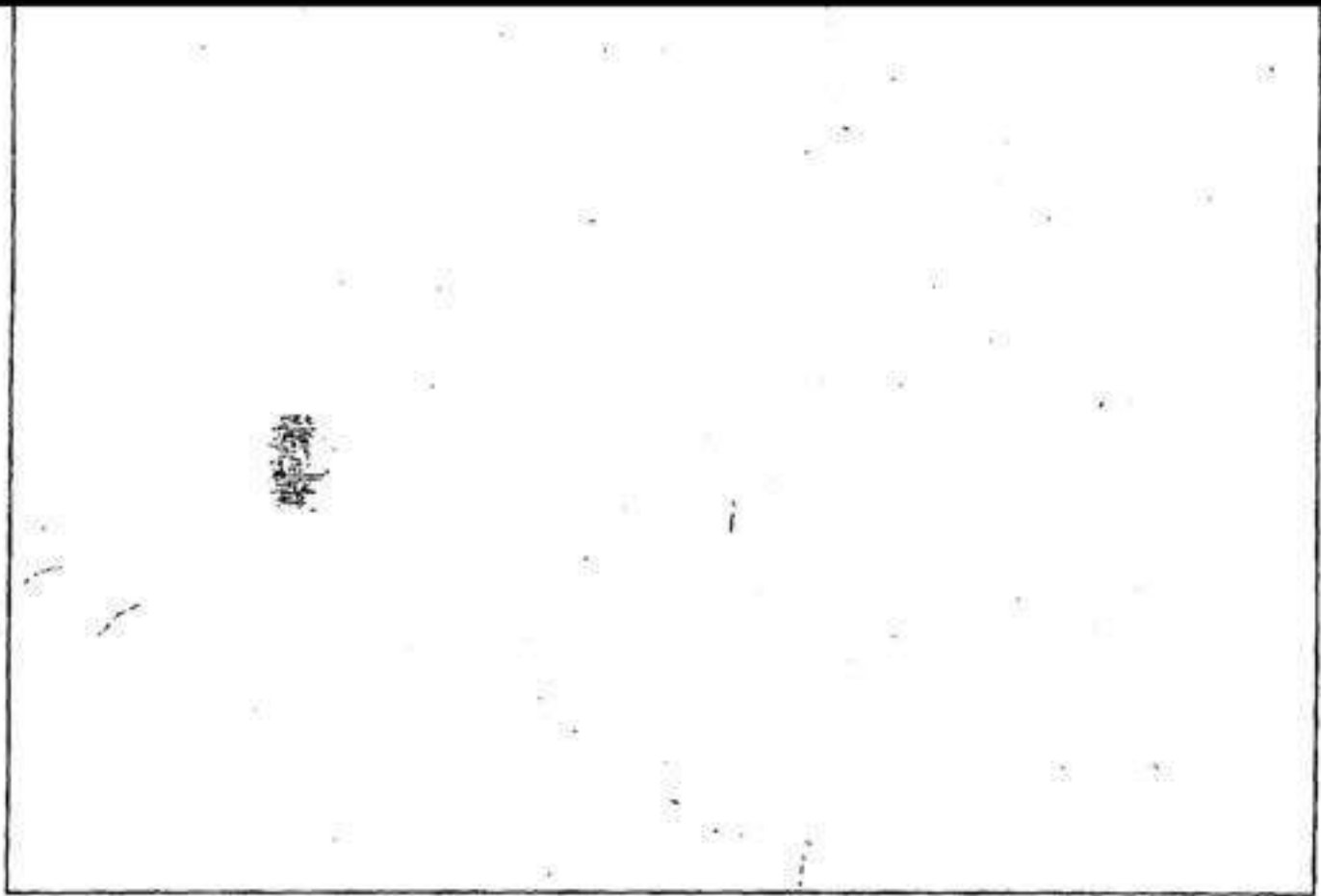
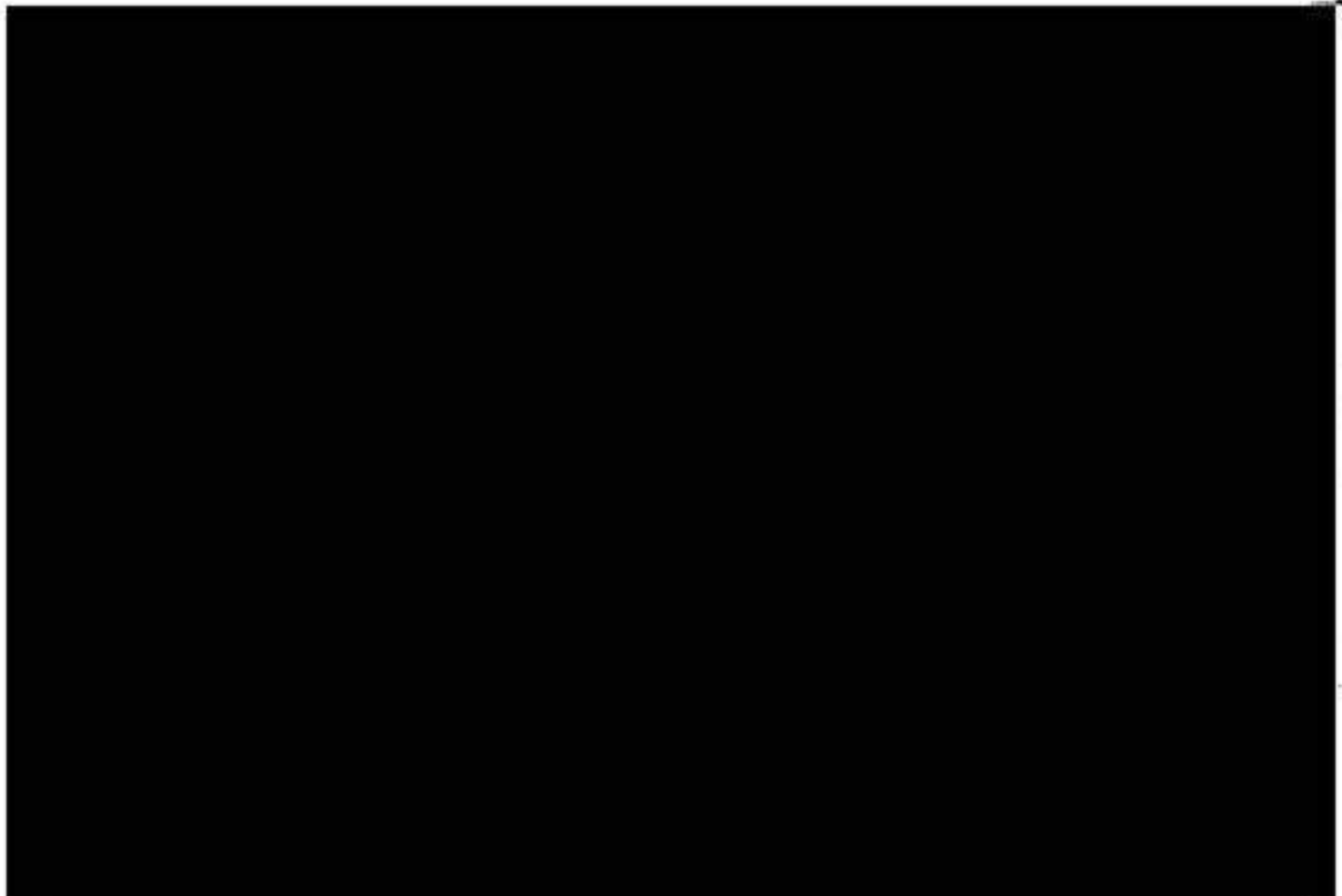



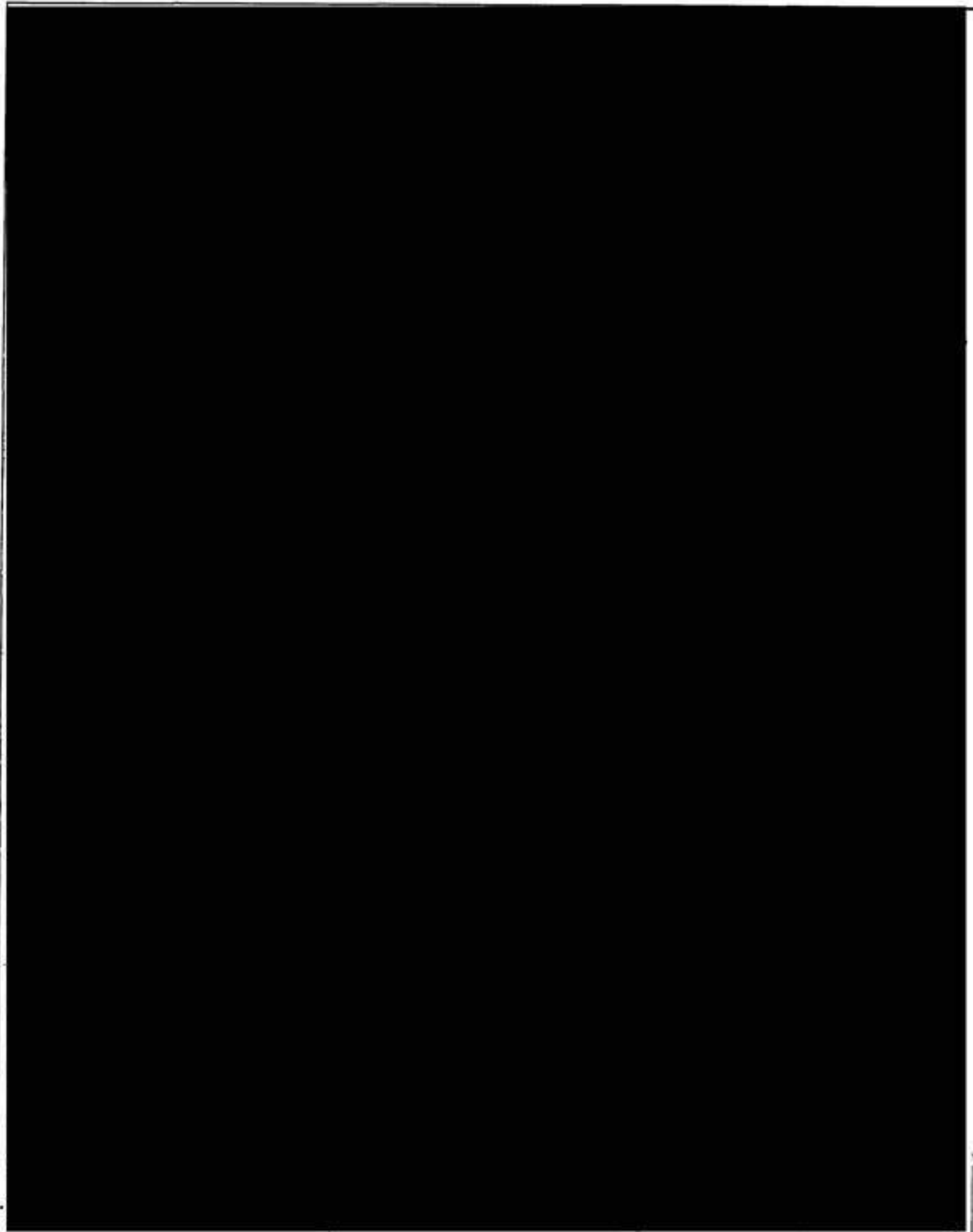

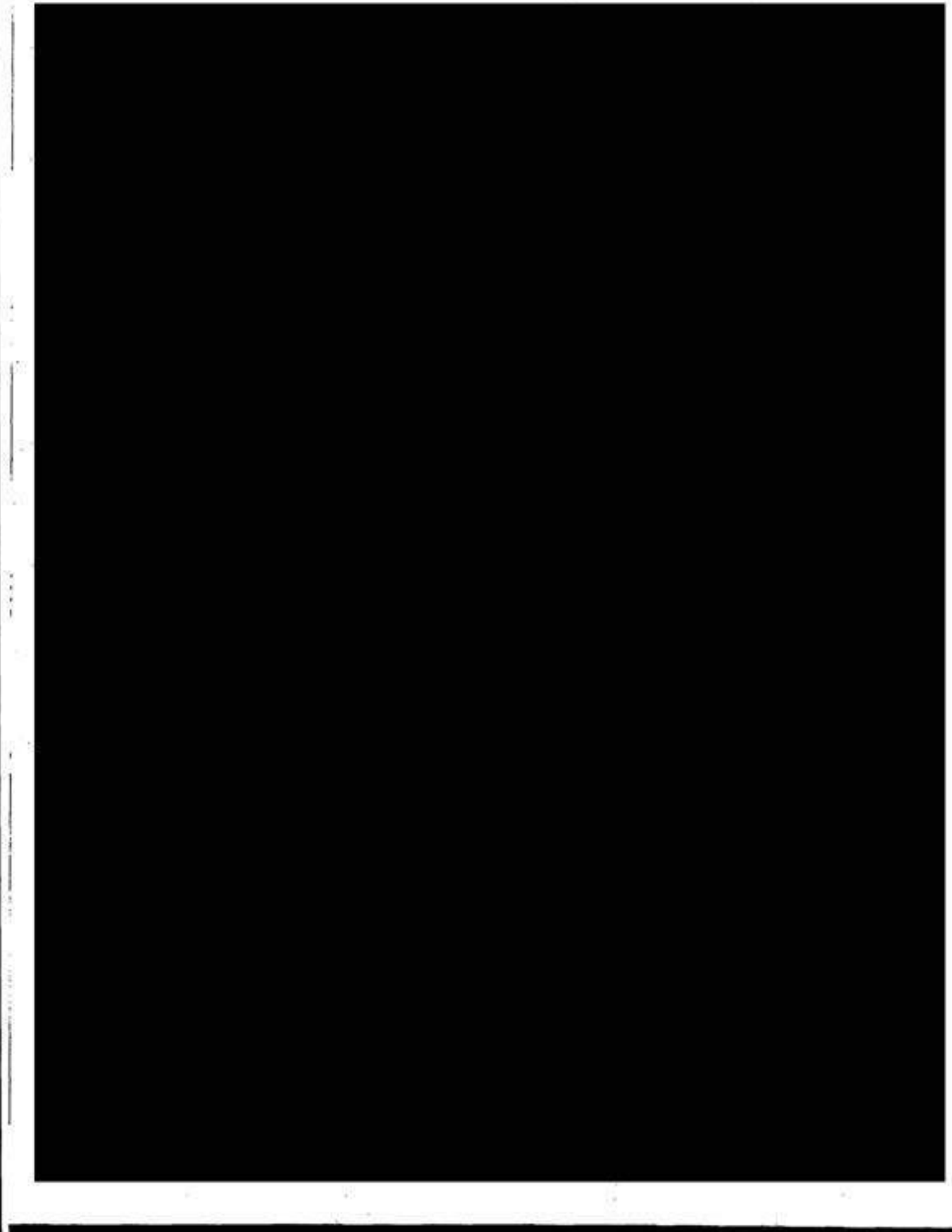

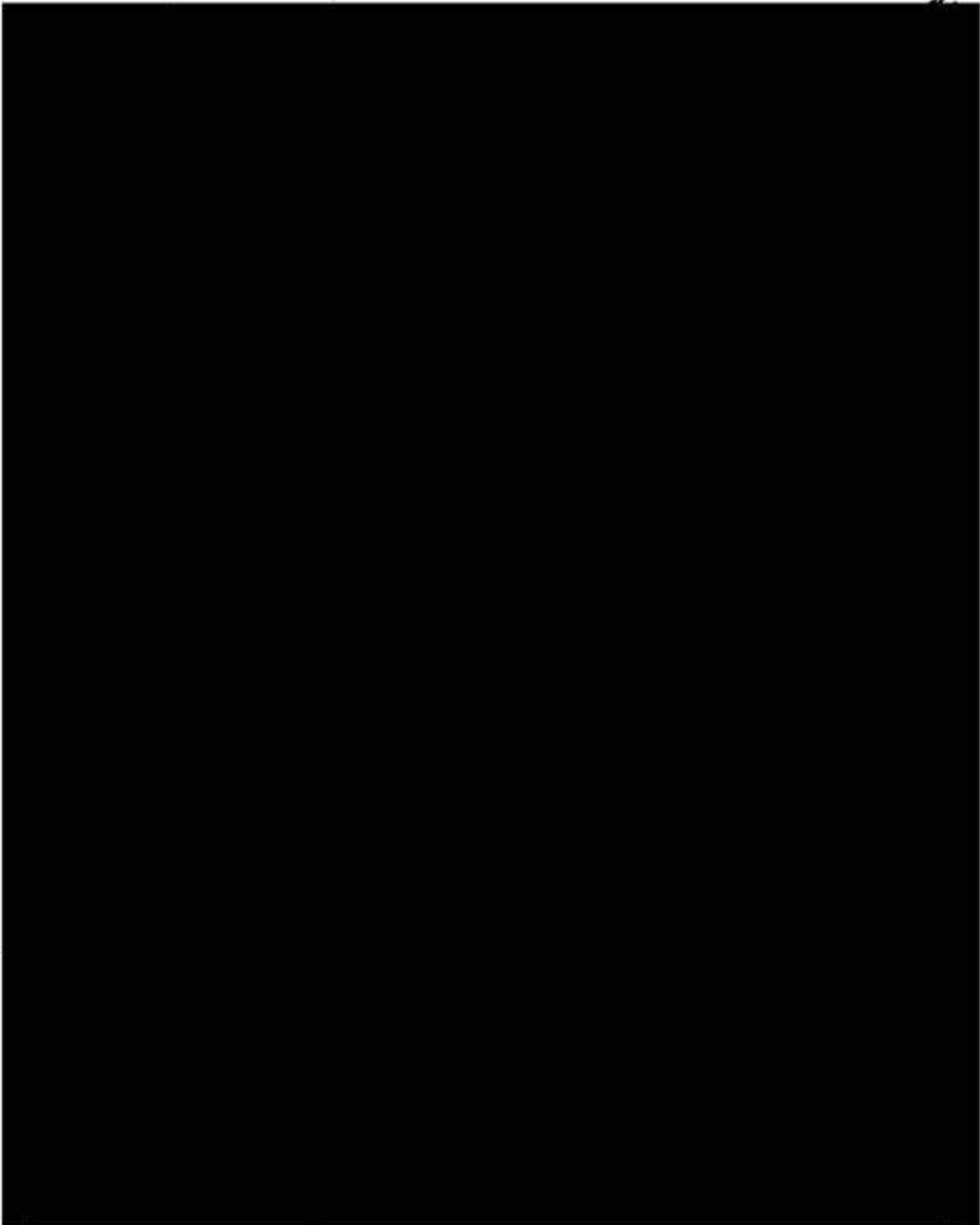

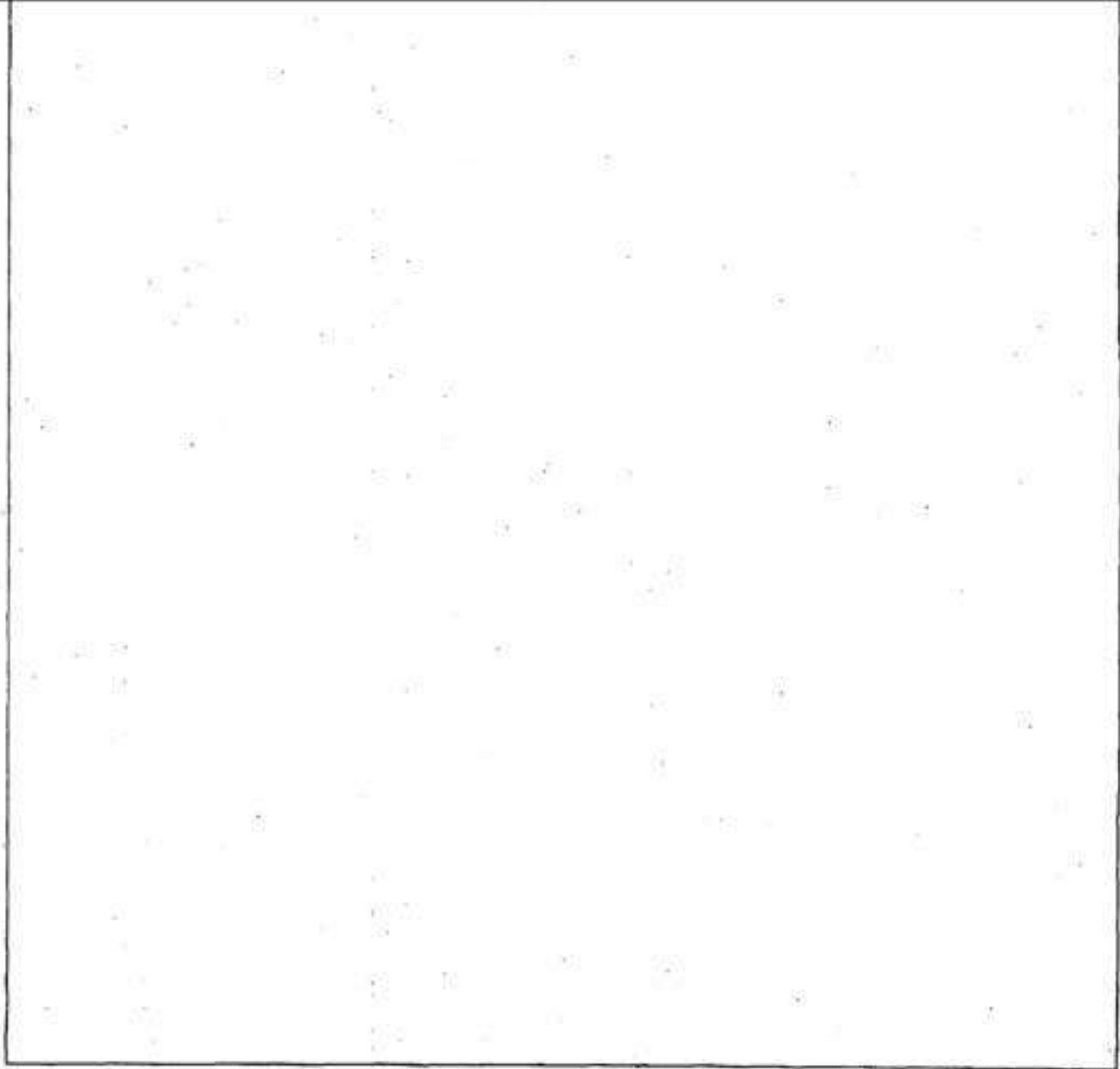

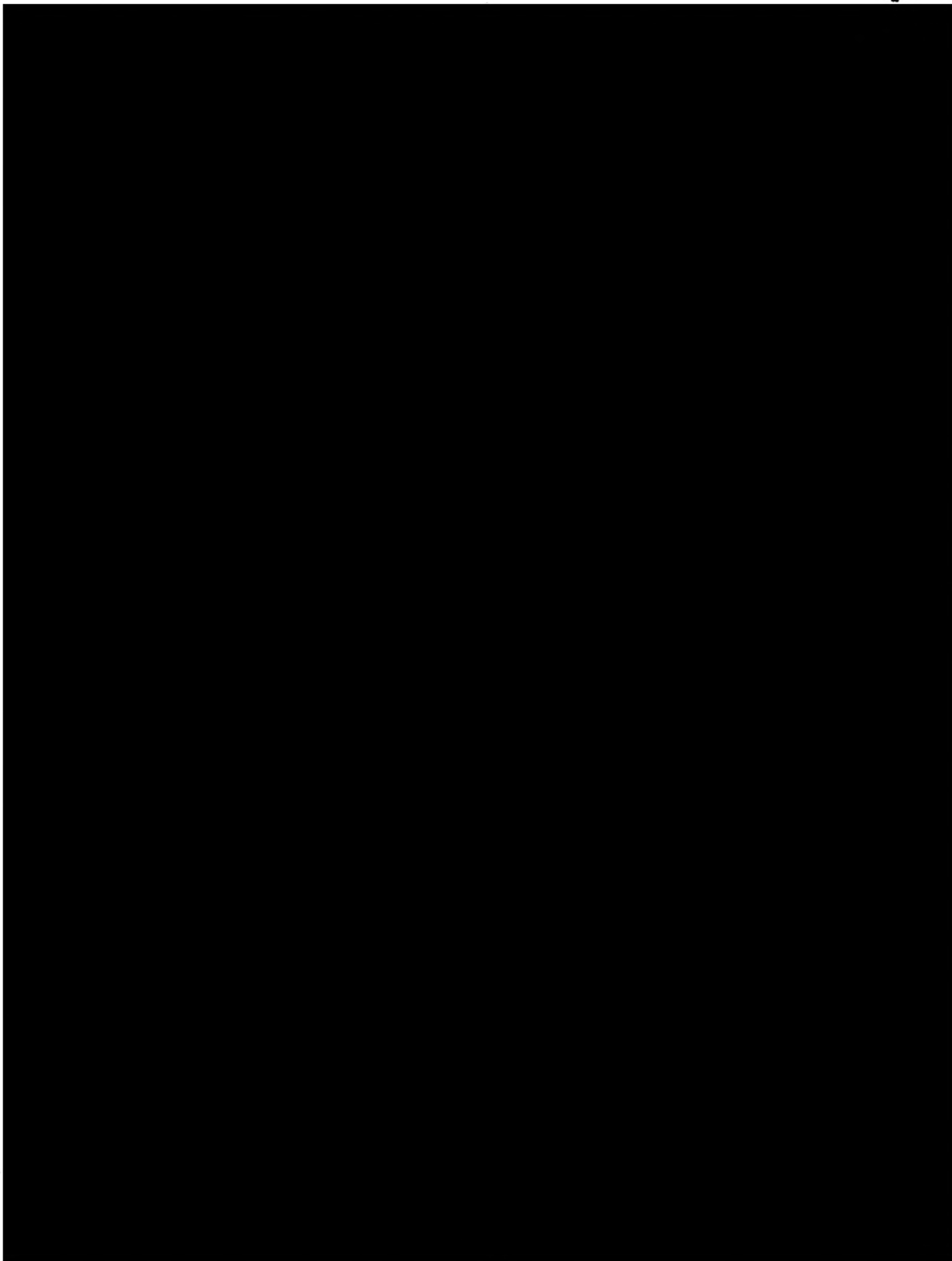

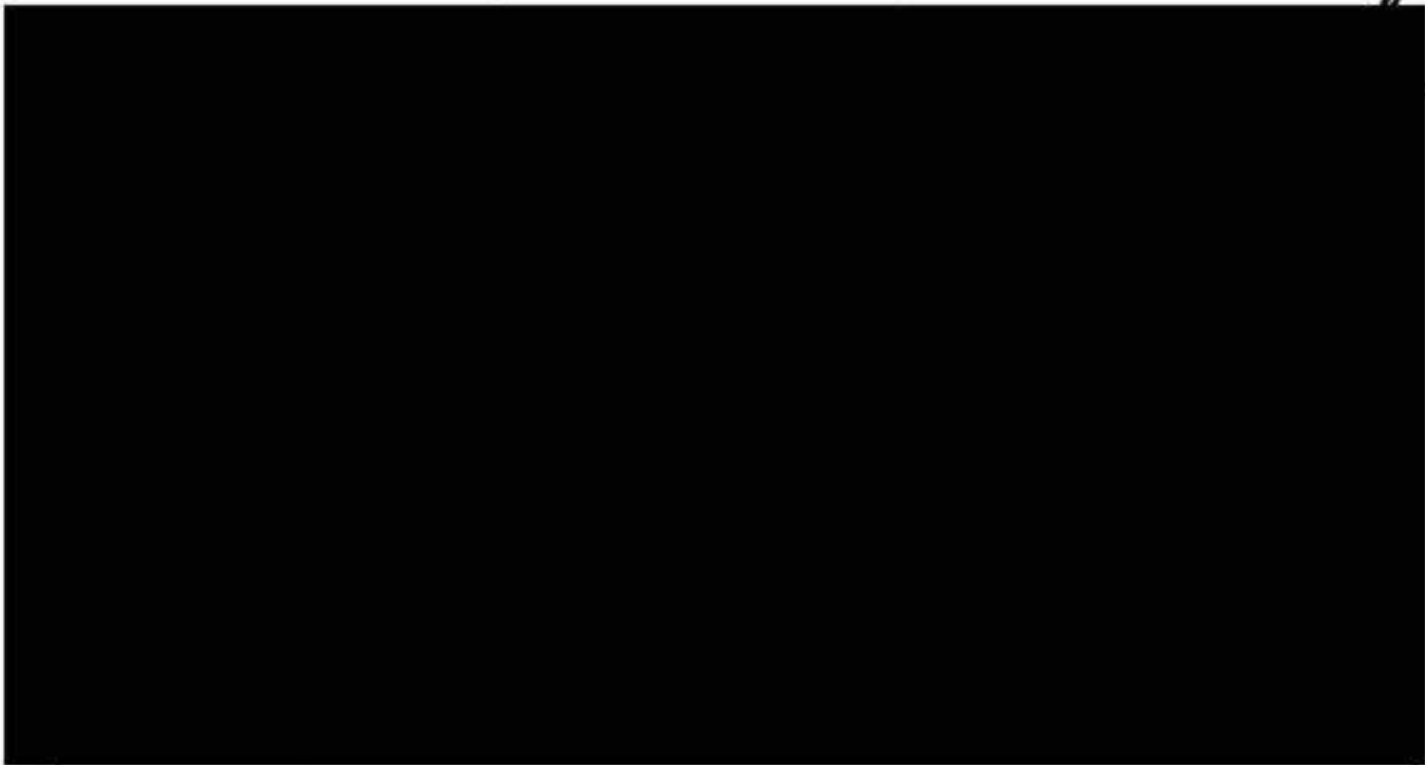

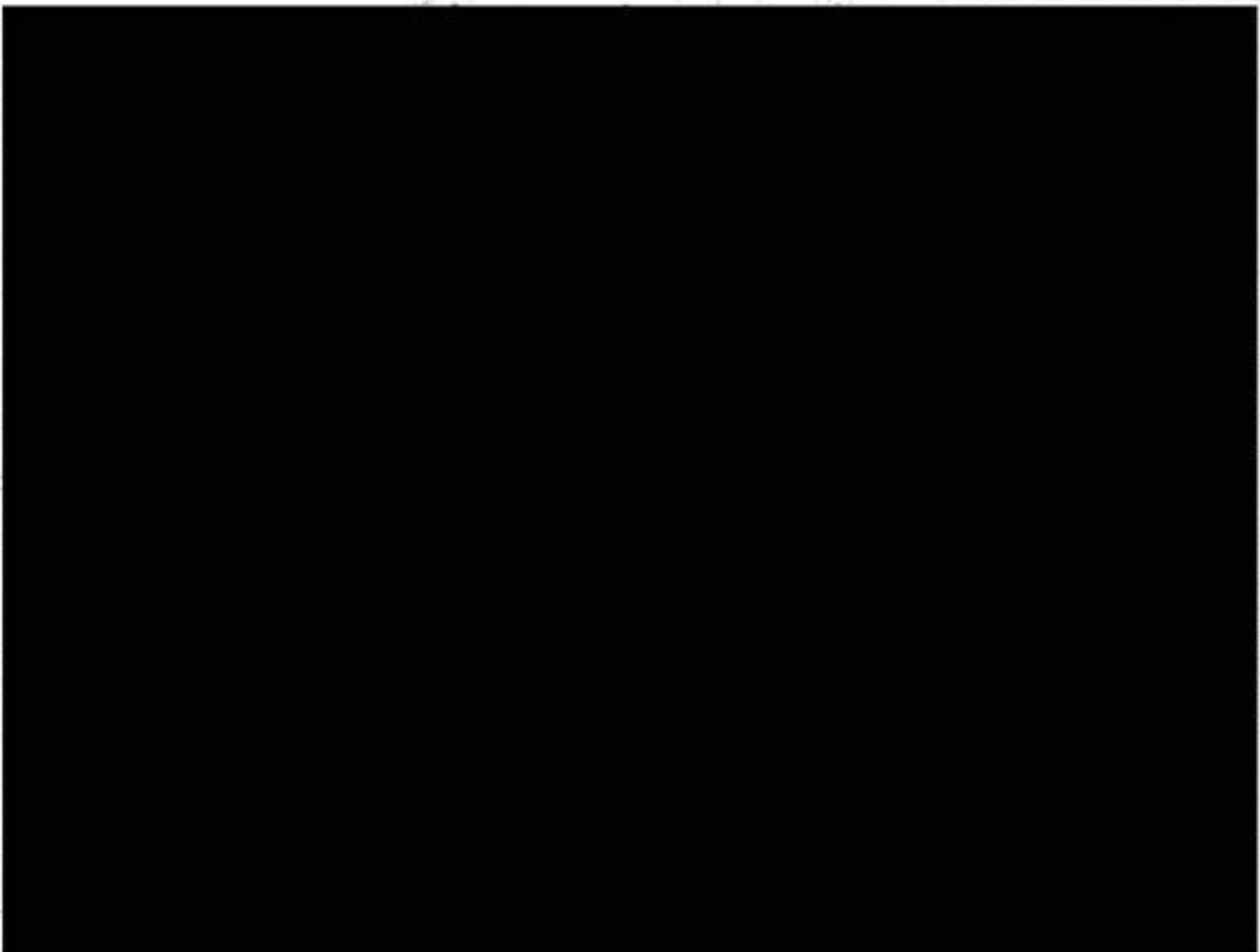

CONTINUE ON REVERSE SIDE

LOCATION OF INTERVIEW	DATE AND TIME OF INTERVIEW	<input type="checkbox"/> ADMITS <input type="checkbox"/> DENIES	ADULT PRESENT AT INTERVIEW	RELATIONSHIP
-----------------------	----------------------------	--	----------------------------	--------------

STATEMENTS OF SUBJECT: NOTE: If subject is under 14, list all facts & statements which indicate subject knew wrongfulness of act(s).

OFFICER TAKING STATEMENT:	SERIAL NO.

CONTINUE ON REVERSE SIDE

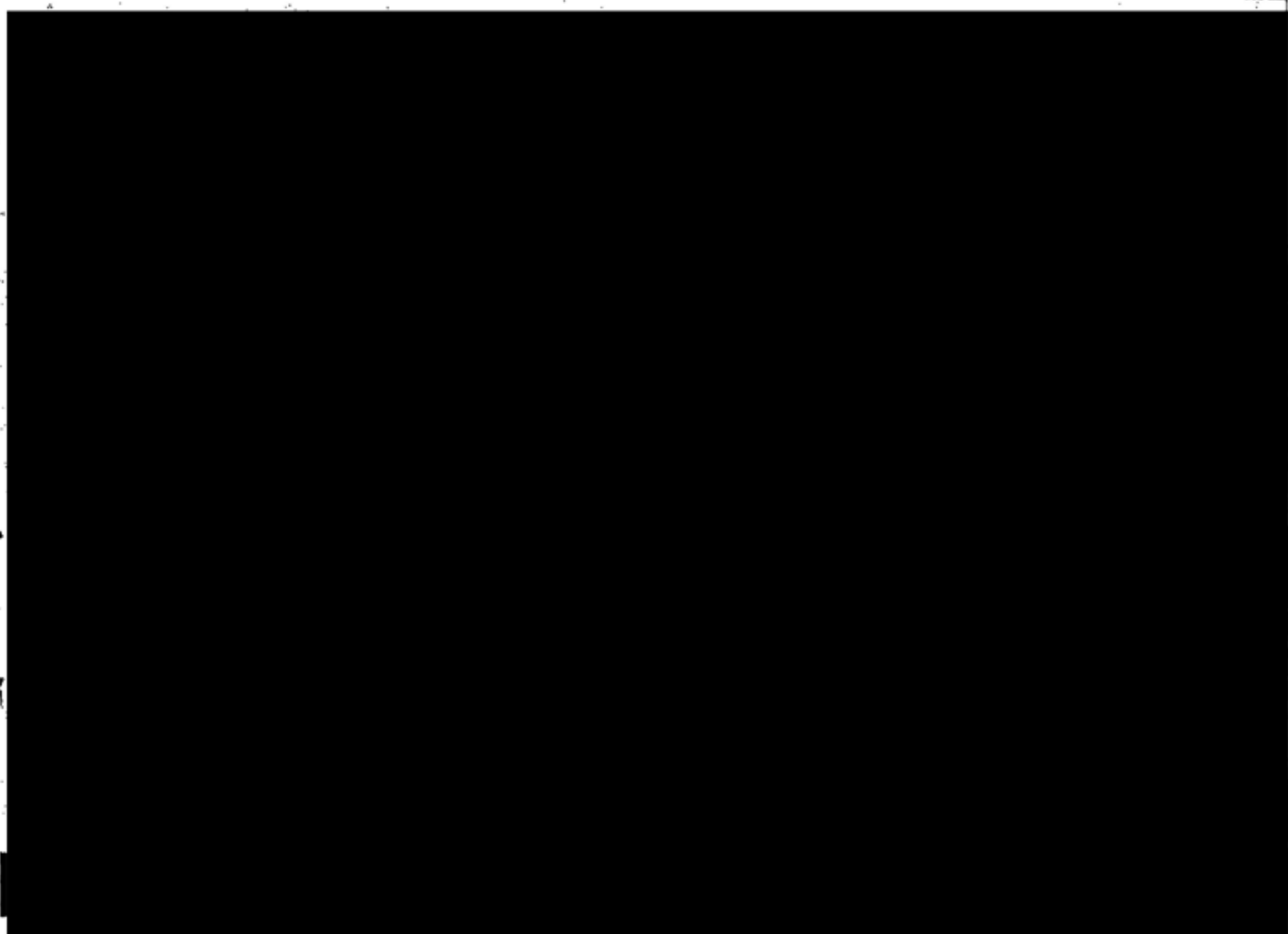

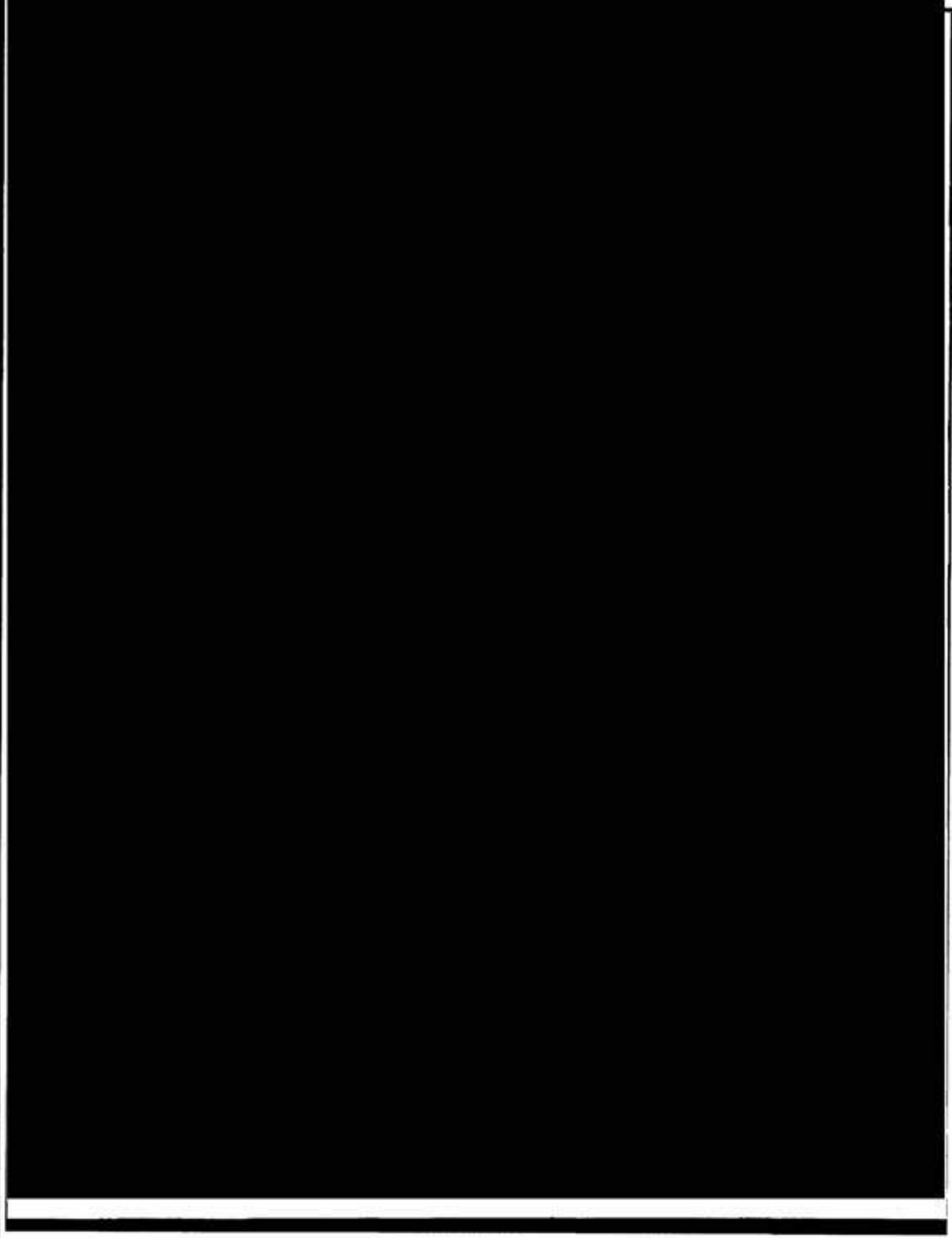

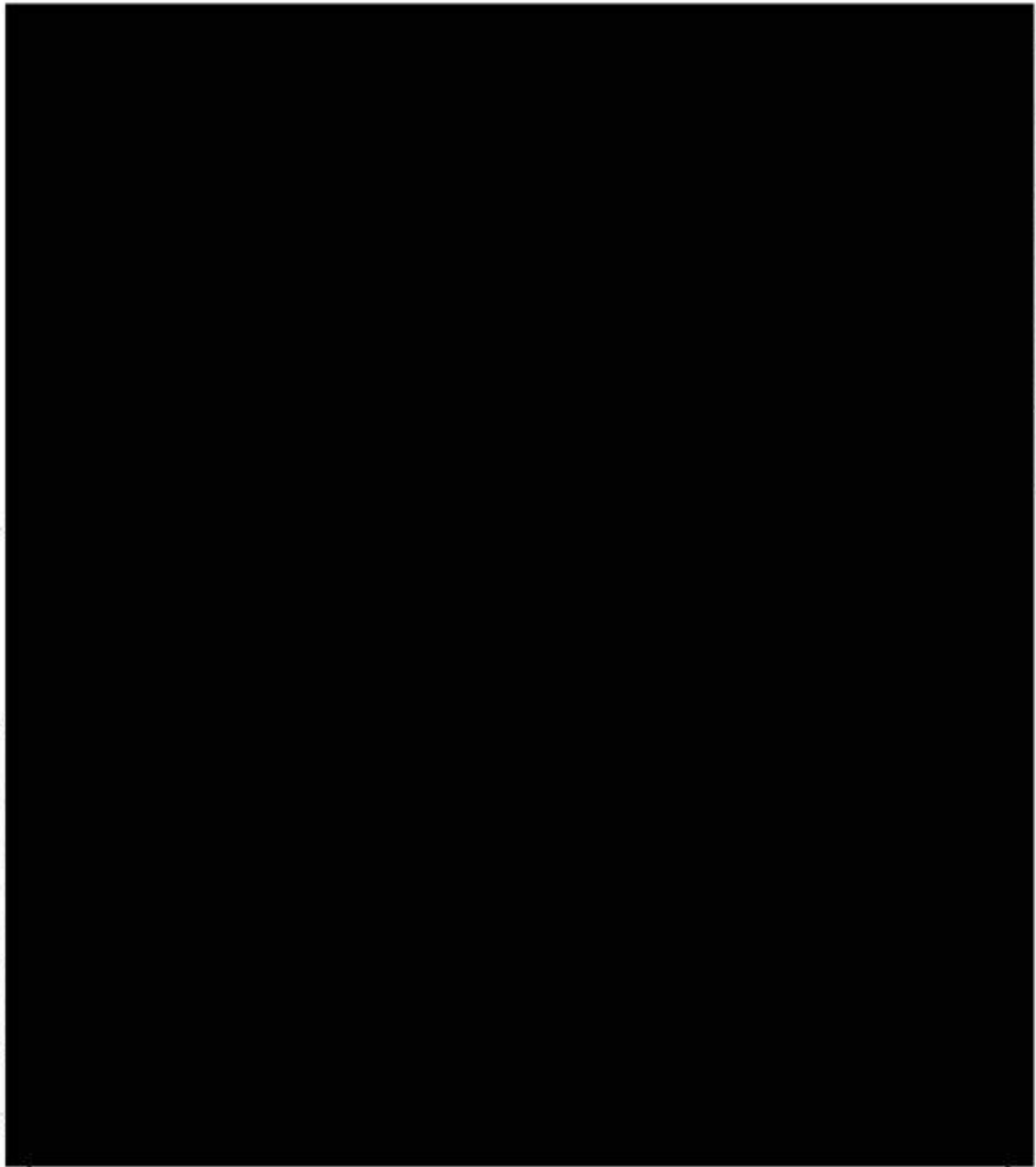

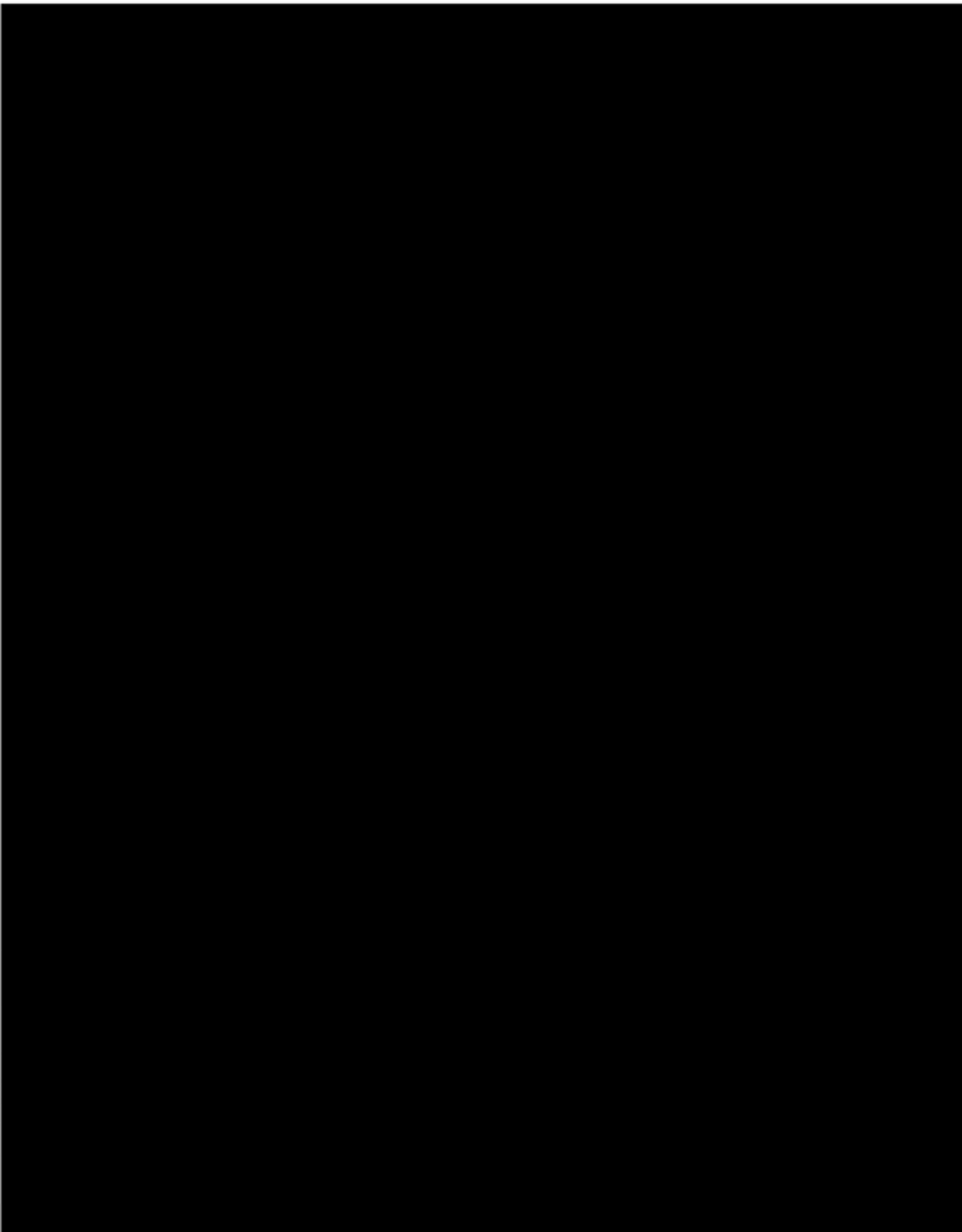

CONTINUATION SHEET

CONTINUATION SHEET

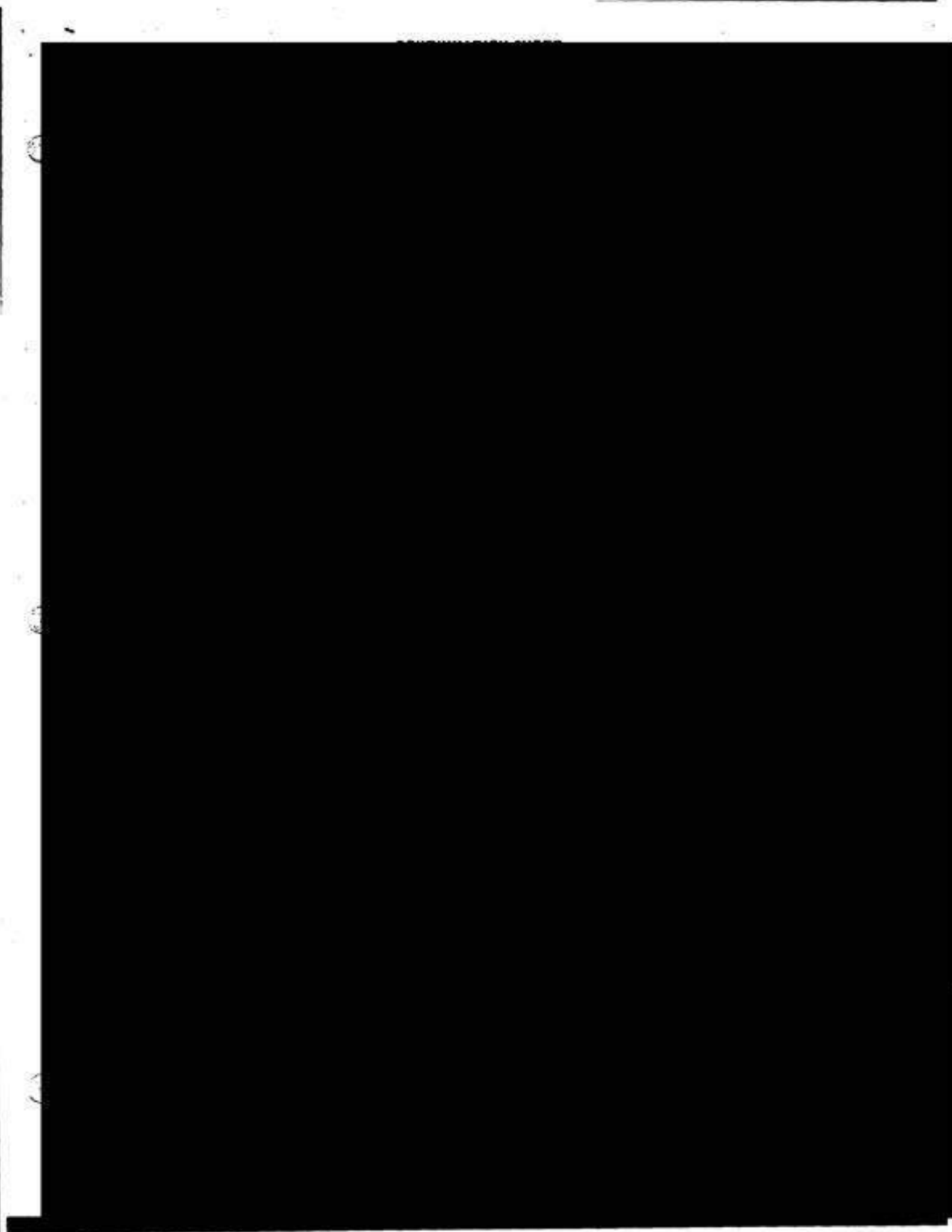

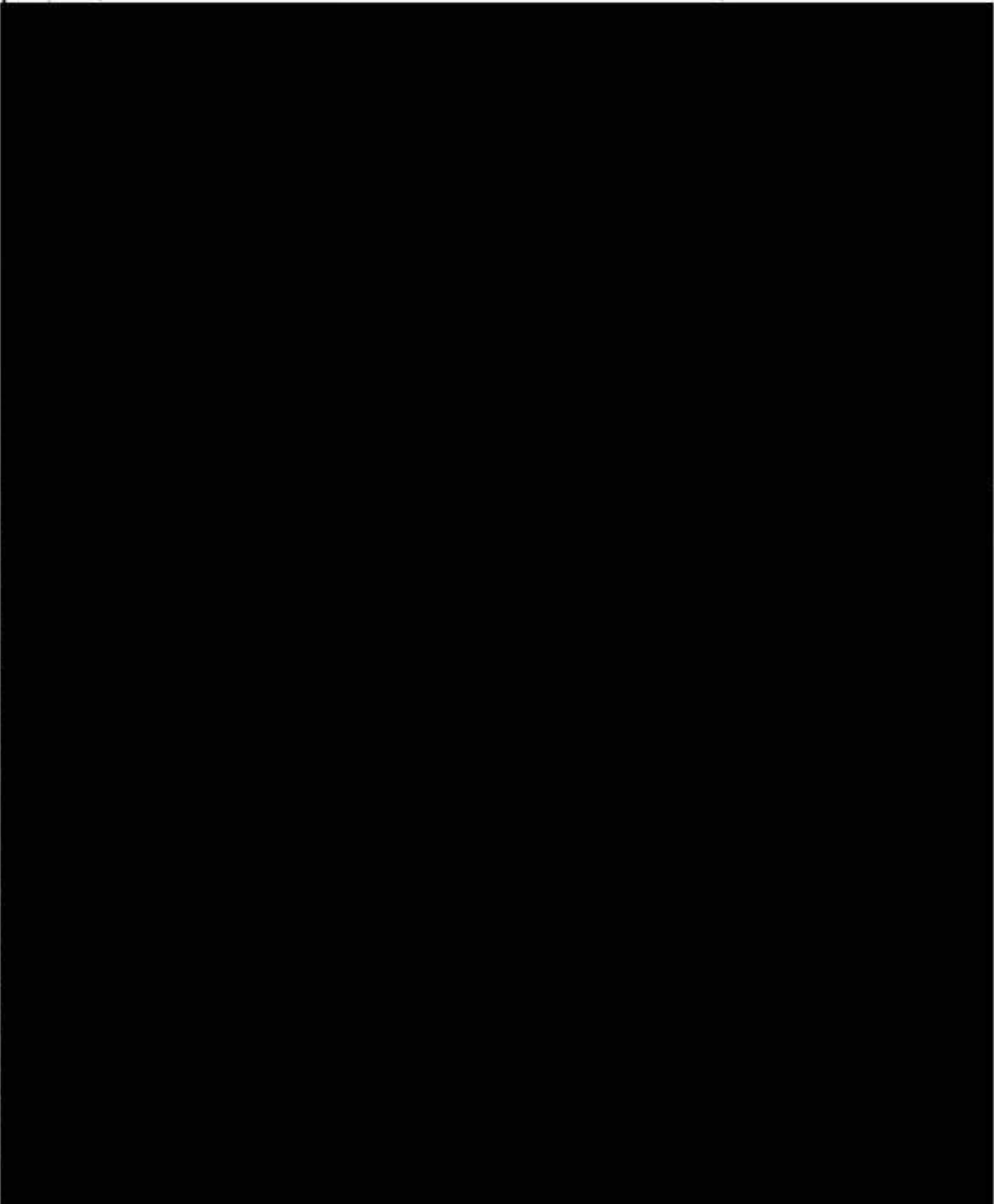

<small>BY DIVISION APPROVED</small> <small>DATE</small>	<small>OFFICE NO.</small> <small>NO.</small>	<small>DATE</small> <small>TIME</small>	<small>BY</small> <small>OFFICER</small> <i>LENT</i>	<small>PERSON REPORTING (PRINT)</small> <i>x</i>
<small>DATE & TIME REPRODUCED</small>	<small>DIVISION</small>	<small>CLERK</small>	<i>RIB</i>	<i>ofc</i>

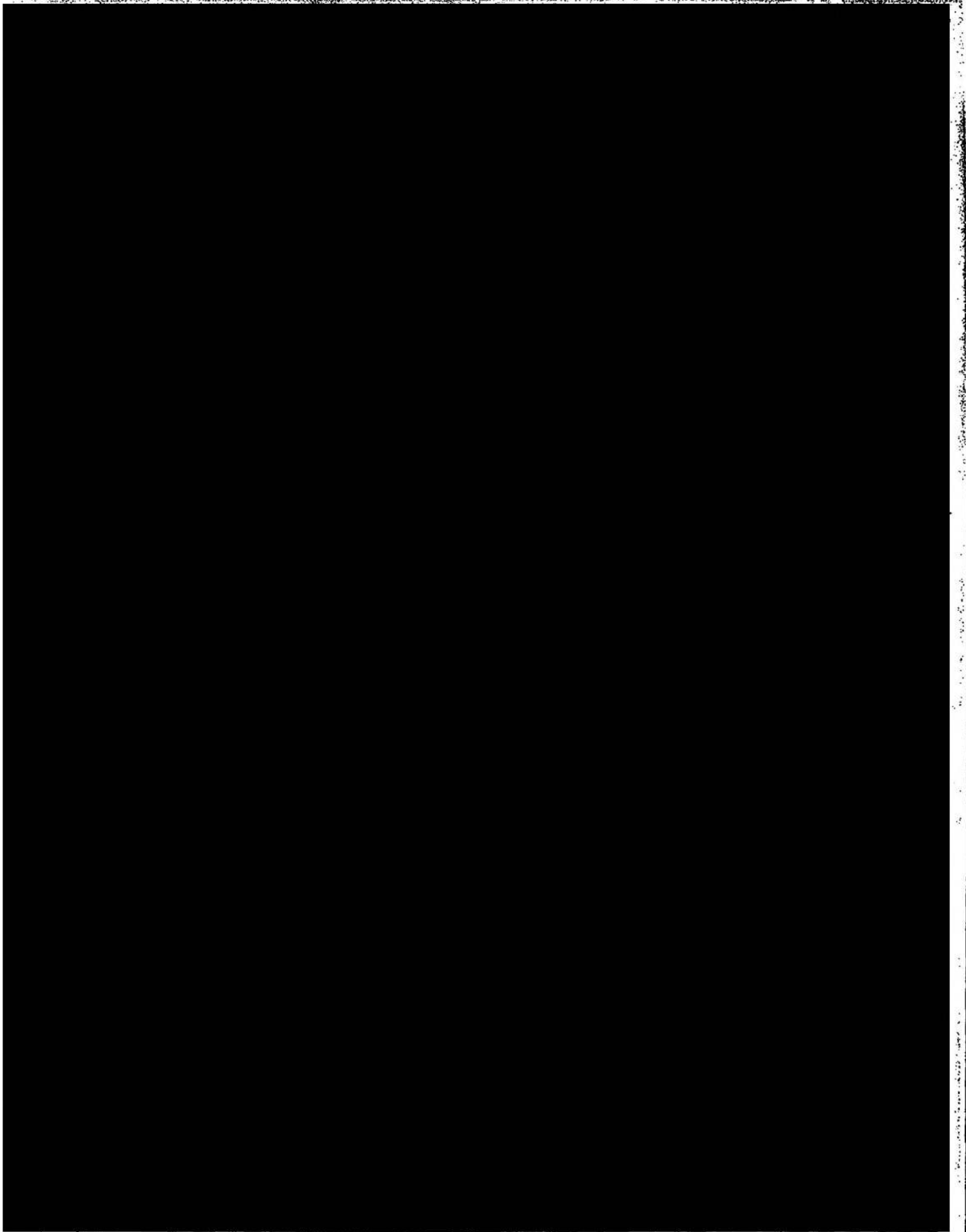

Ventura County Sheriff's Department
Detention Services
PreBook Booking Sheet

10/5
3924

Inmate's File

Canley, Adrian D

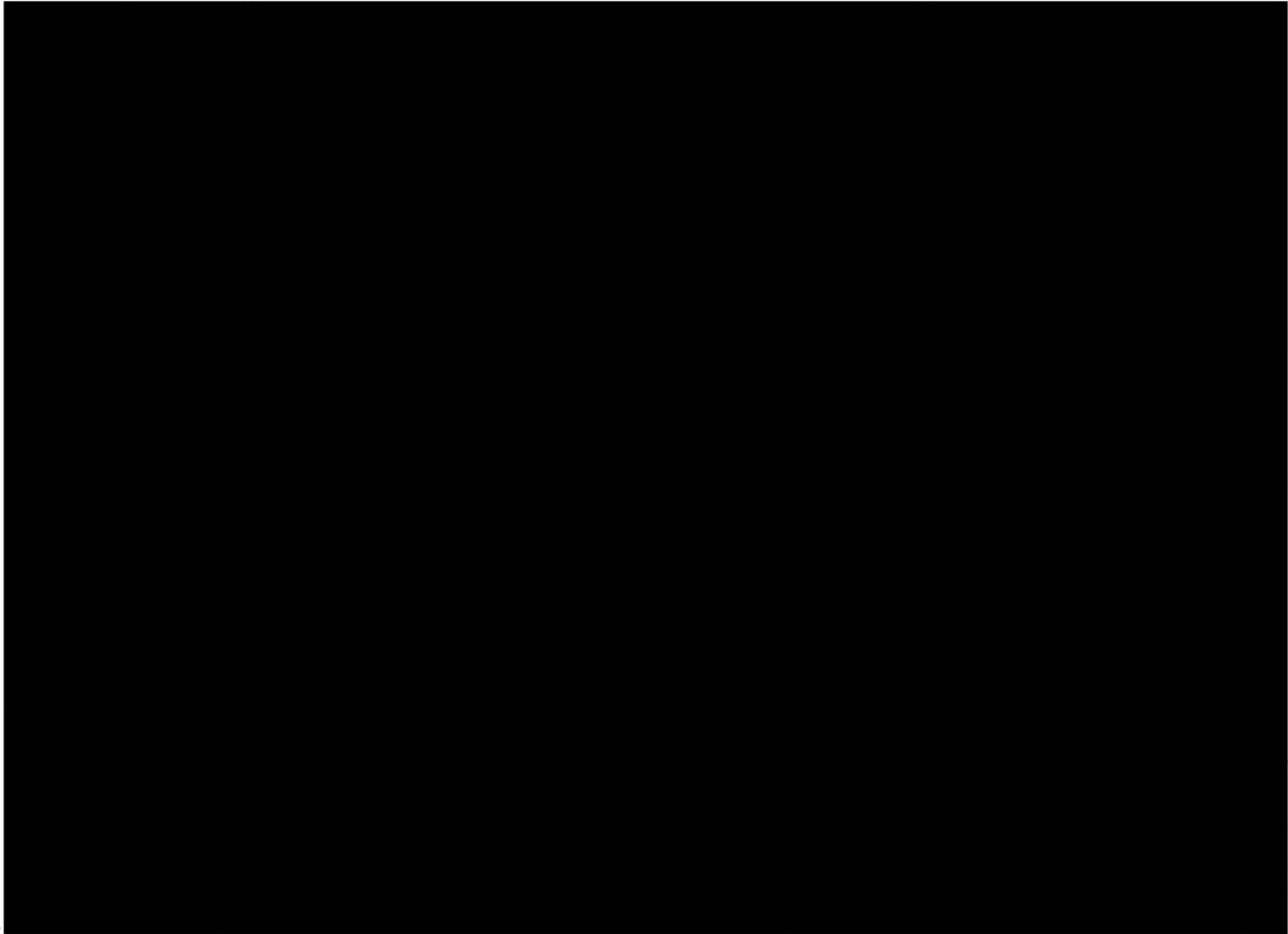

BOOKING APPROVED BY
[Signature]
SUPERVISOR/ID#

Ventura County Sheriff's Department
Detention Services
PreBook Booking Sheet

Inmate's File

Canley, Adrian D

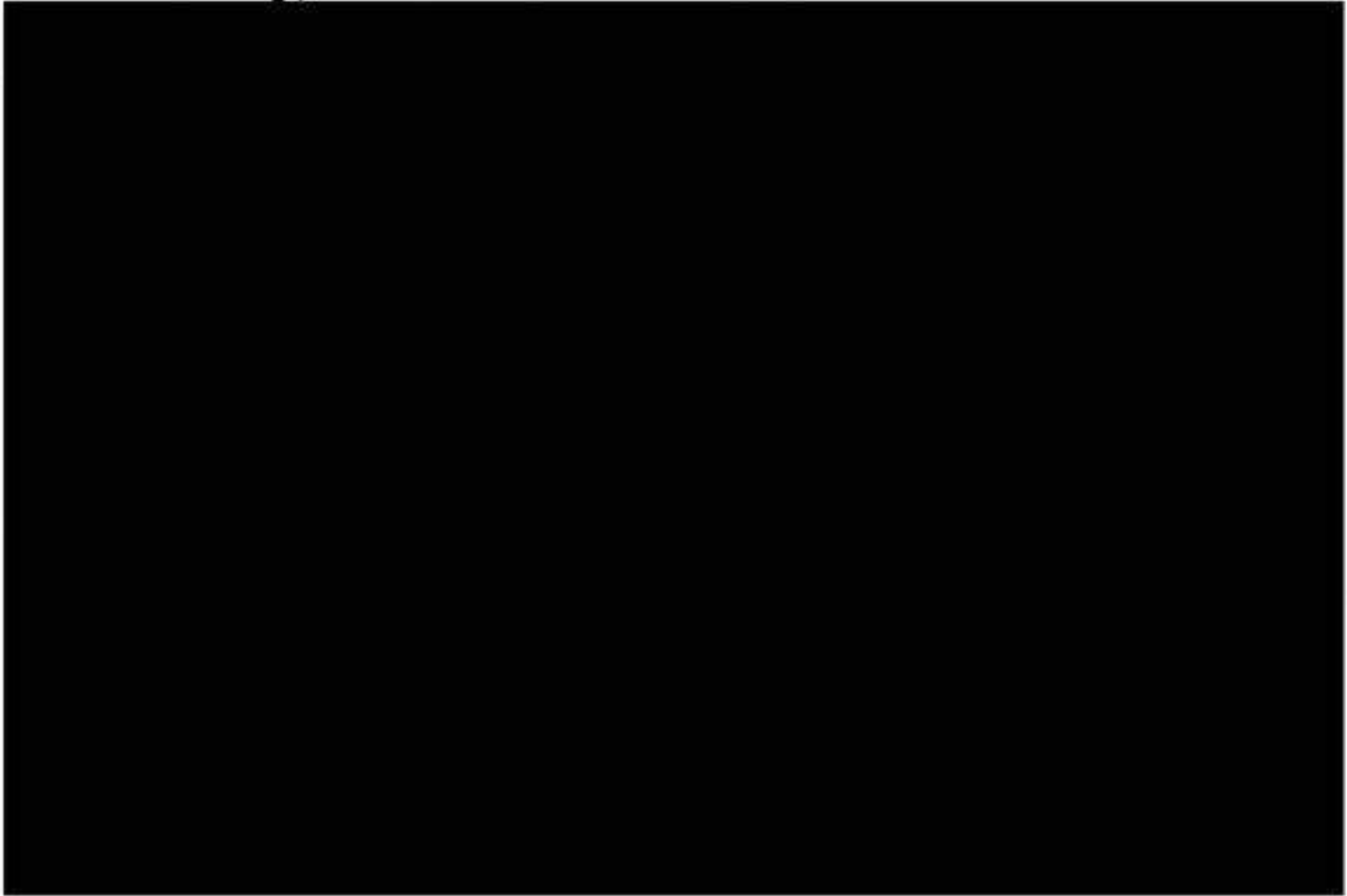

VENTURA COUNTY SHERIFF'S DEPARTMENT * CUSTODY DIVISION
INTAKE HEALTH SCREENING

1/11/12

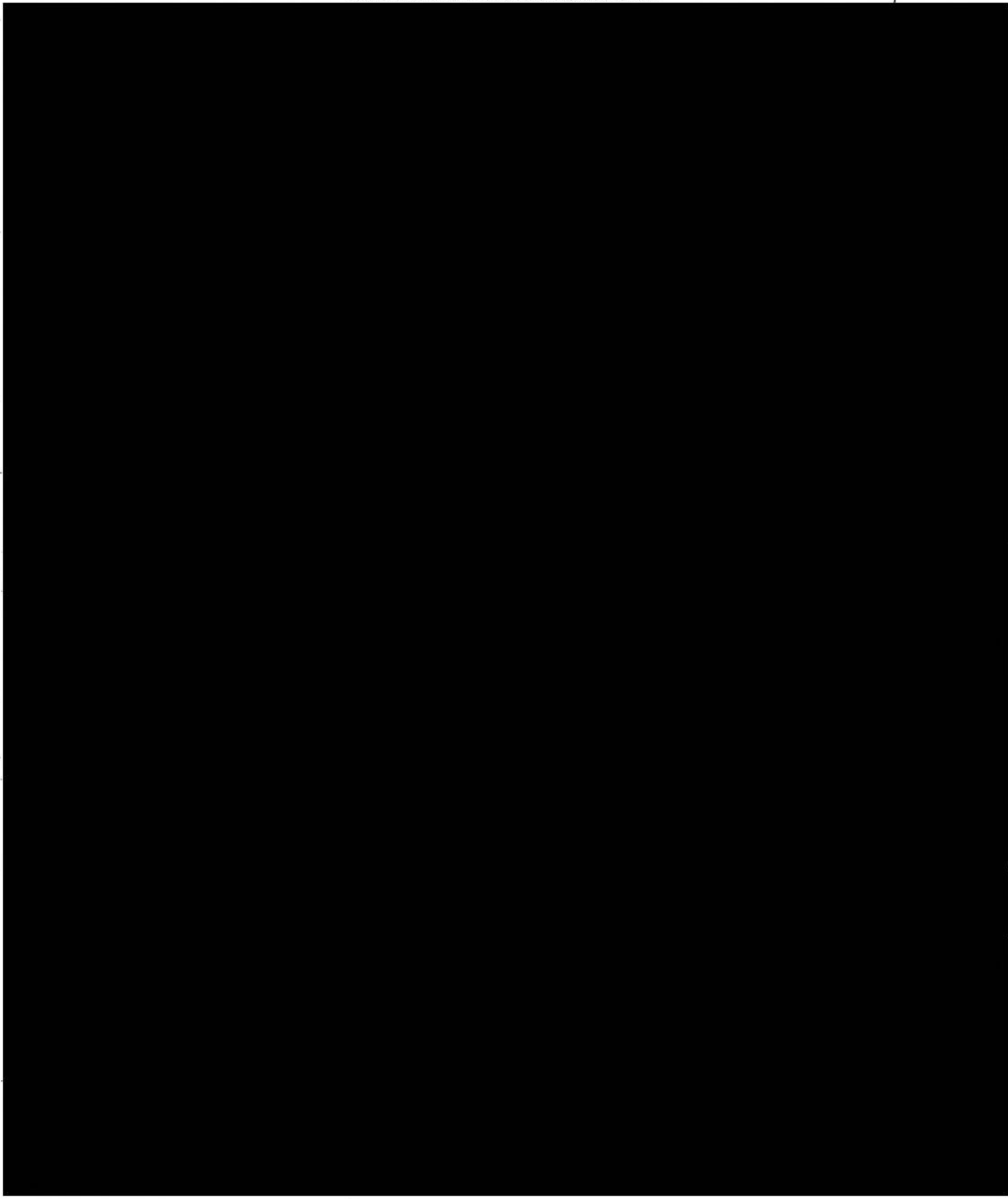

APPLICATION FOR BAIL/OWN RECOGNIZANCE (O.R.) RELEASE

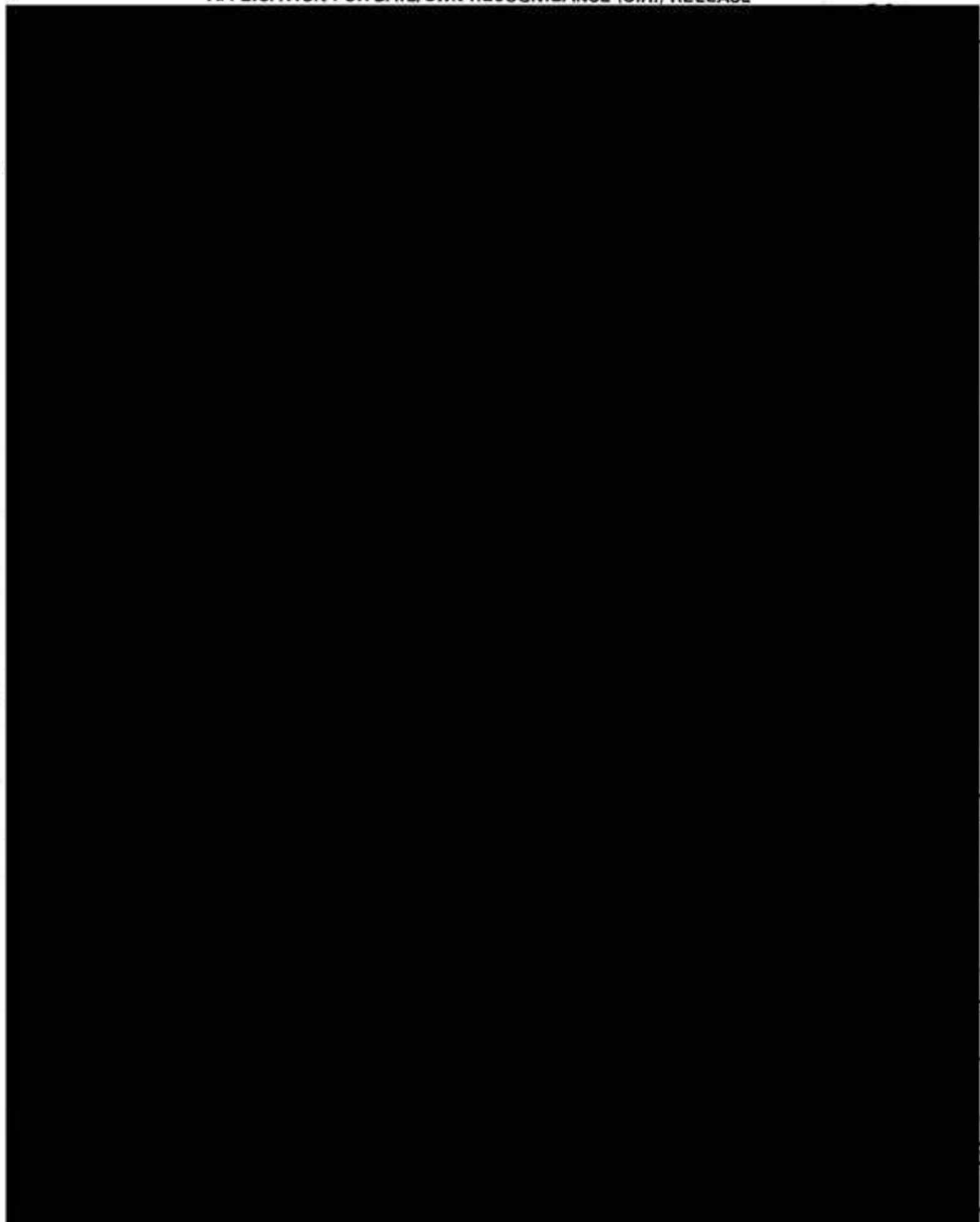

Ventura County Sheriff's Department
Detention Services
Master Booking Sheet



Canley, Adrian D

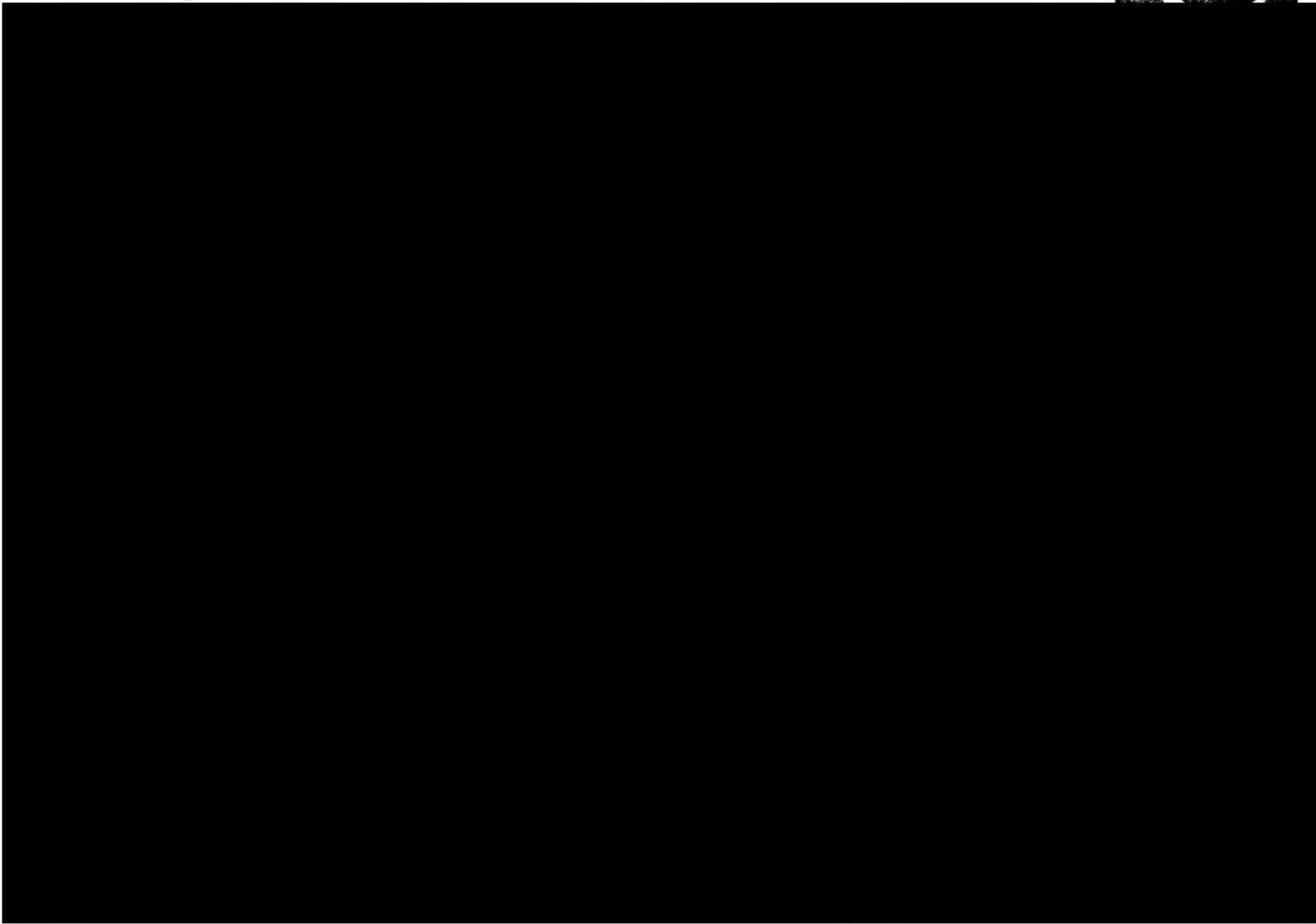

MC - Bill Ayub
CR
11/22/06

[Handwritten signature]
10/3/06/11/21

**Ventura County Sheriff's Department
Detention Services
Master Booking Sheet**

Canley, Adrian D



<u>Final Release</u>	Release Disposition <i>OR</i>		Bail Bond/BFR Number	
To Appear At <i>11</i>	Court Date <i>11-6-06</i>		Court Time <i>0900</i>	
Release To	Department		Release Approval <i>[Signature]</i>	
Release Wrt. Check <i>3979</i>	Prepared By <i>3979</i>	Released By <i>4349</i>	Date <i>10-5-06</i>	Time <i>1849</i>

COMMITMENT ORDER

Case Number 2006037553

People Vs Canley, Adrian

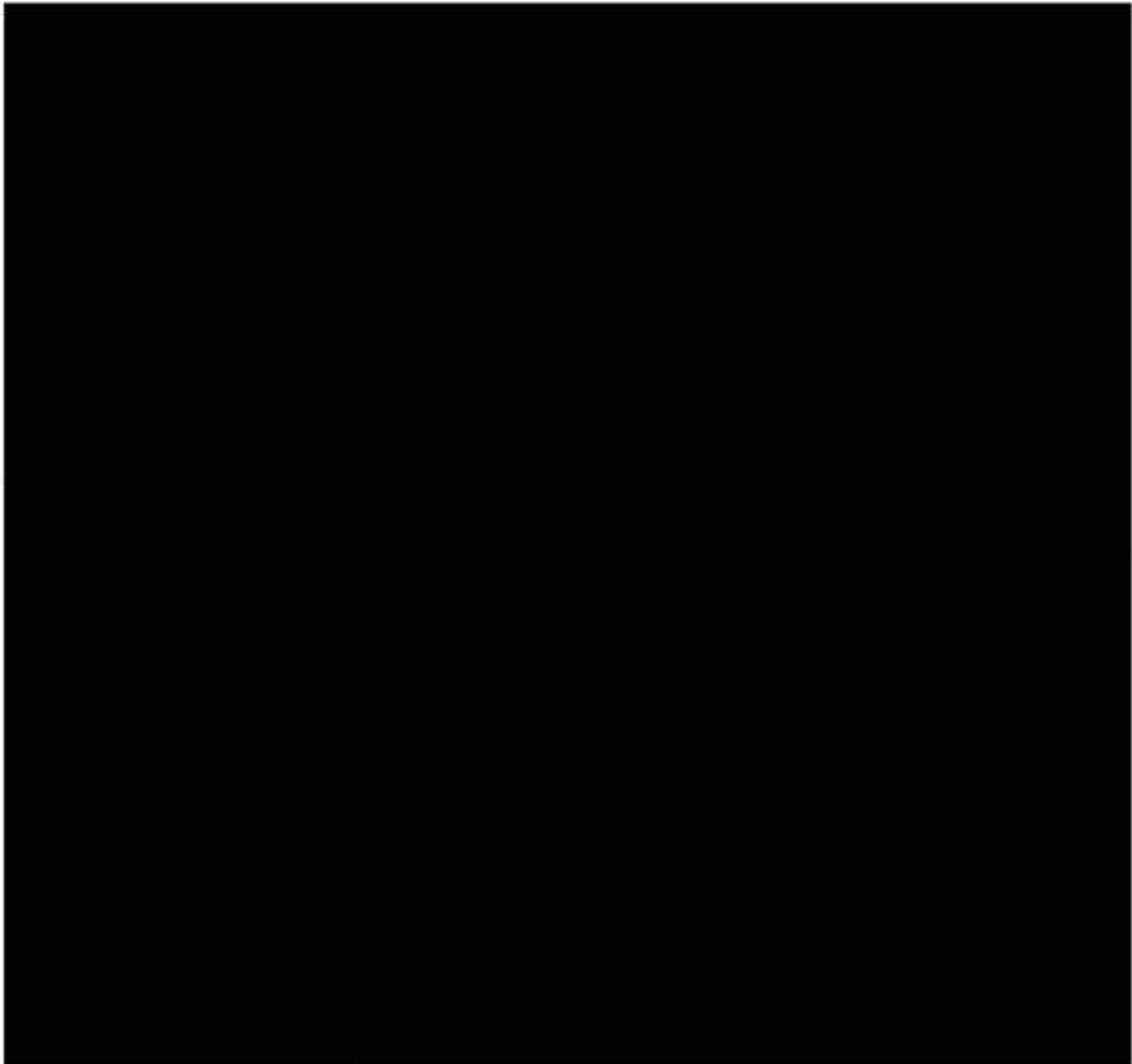

Ventura County Sheriff's Department
Detention Services
Master Booking Sheet

Canley, Adrian D

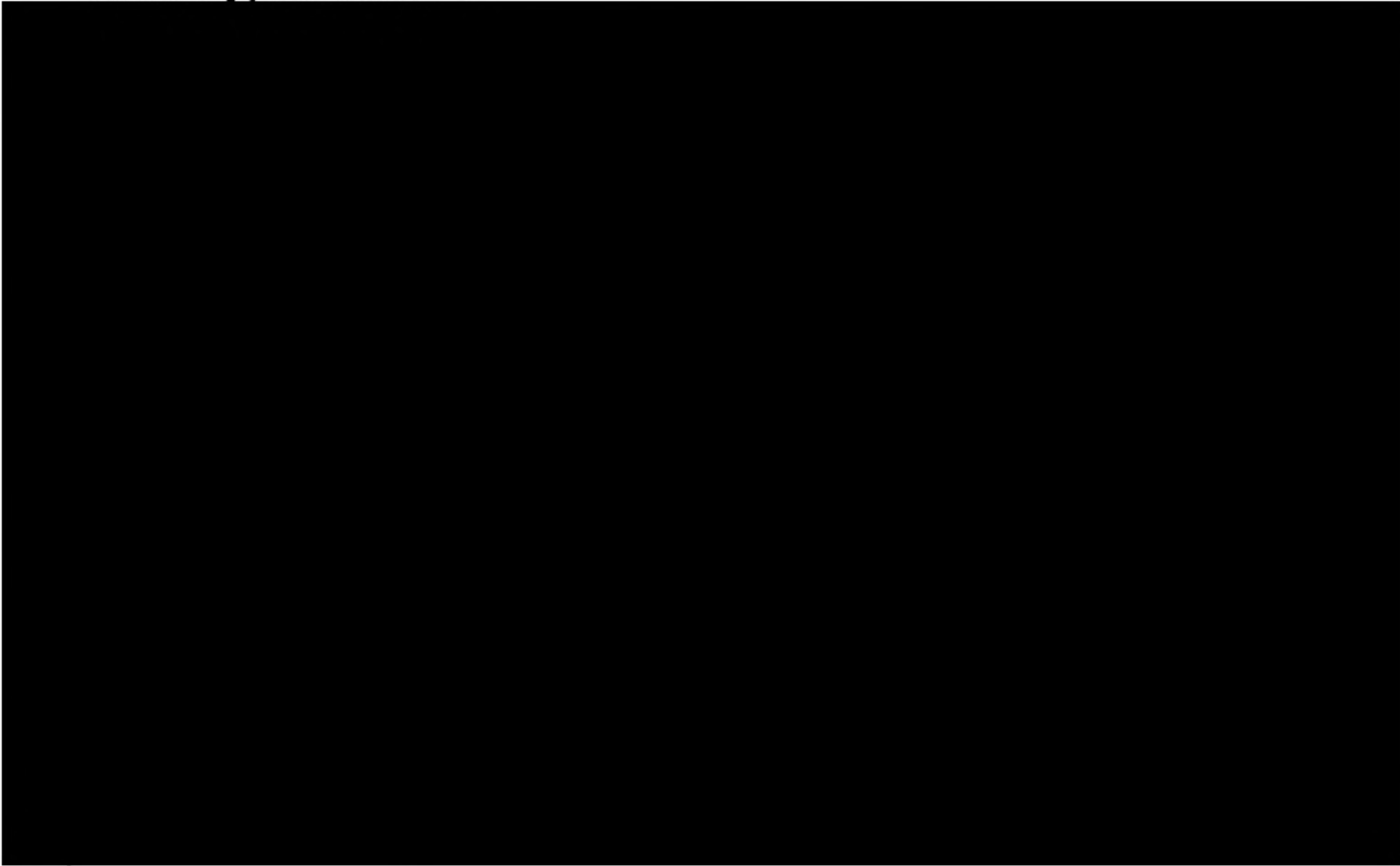

I understand my signature acknowledges the correctness of the information furnished by me.

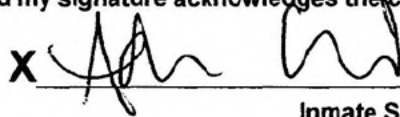
X  _____
Inmate Signature

Ventura County Sheriff's Department
Detention Services

Property Returned to Inmate at Release

Canley, Adrian D

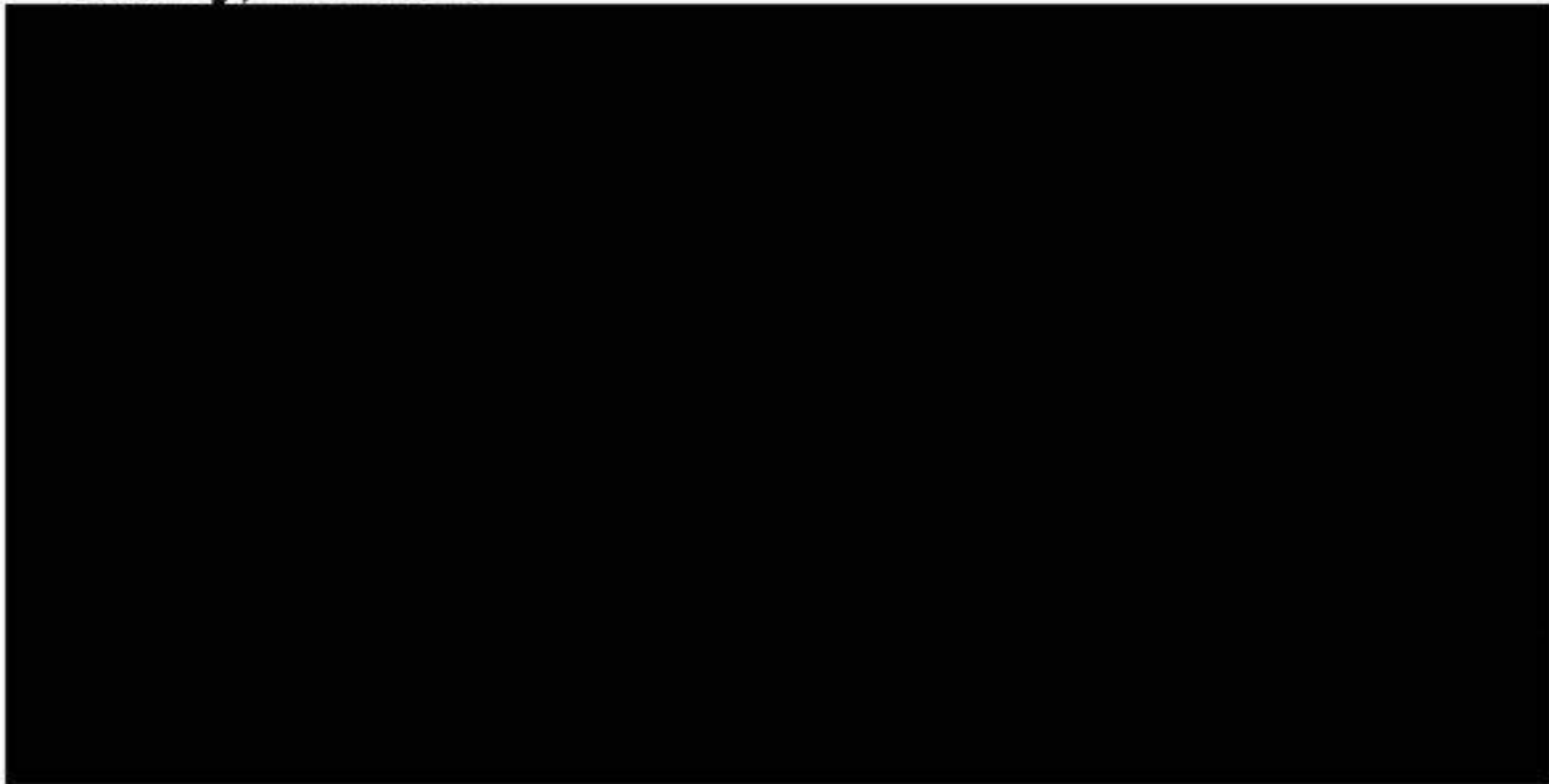

<u>Release Cash</u>	<u>Tracer Number</u>
\$0.00	

I hereby certify that I have received all money and property held in trust for me by Ventura County Jail.

X [Signature] _____
Inmate Signature Date

X GARWILL 4349 _____
Signature and ID of officer releasing property Date

Fingerprint Card

Live Scan ID: H11 Mens Booking

Inmate Name: CANLEY, ADRIAN D

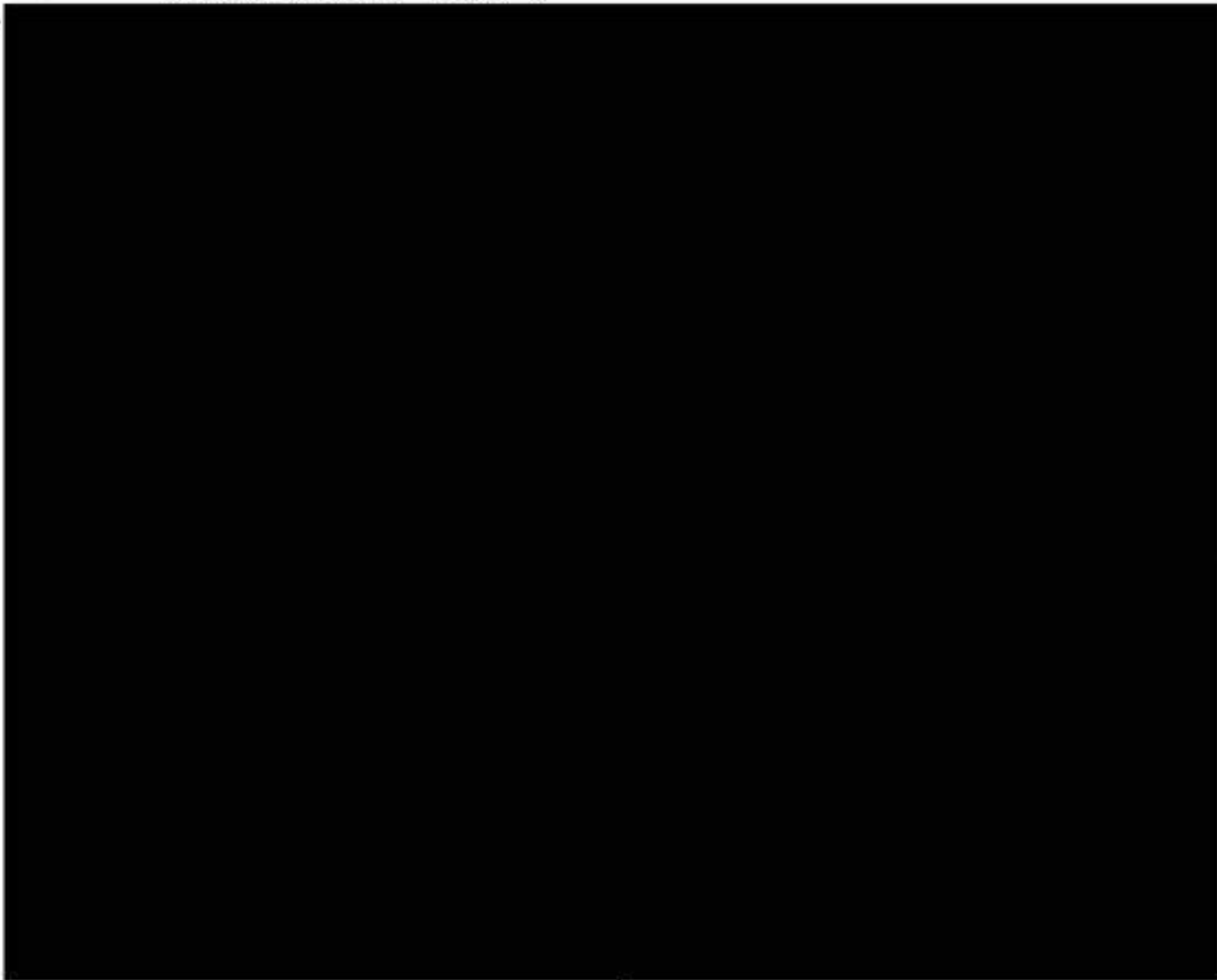

Flat Fingerprints

Right Hand at RELEASE

Flat Fingerprints

Right Hand at BOOKING

*Instructions: Place the full length of all four fingers on the right hand in the right box if they are being booked.
Use the left box if they are being released.*

Ventura County Sheriff's Department
Detention Services

9/26

PreBook Booking Sheet

Inmate's File

Canley, Adrian Doyle



Arrest Date/Time: 09/22/2006 11:00
Reception Date/Time:
Master Date/Time:
Booking Cash: \$0.00

Booking No: 1270.1 P.O. 8
Sheriff's BI Nbrs:

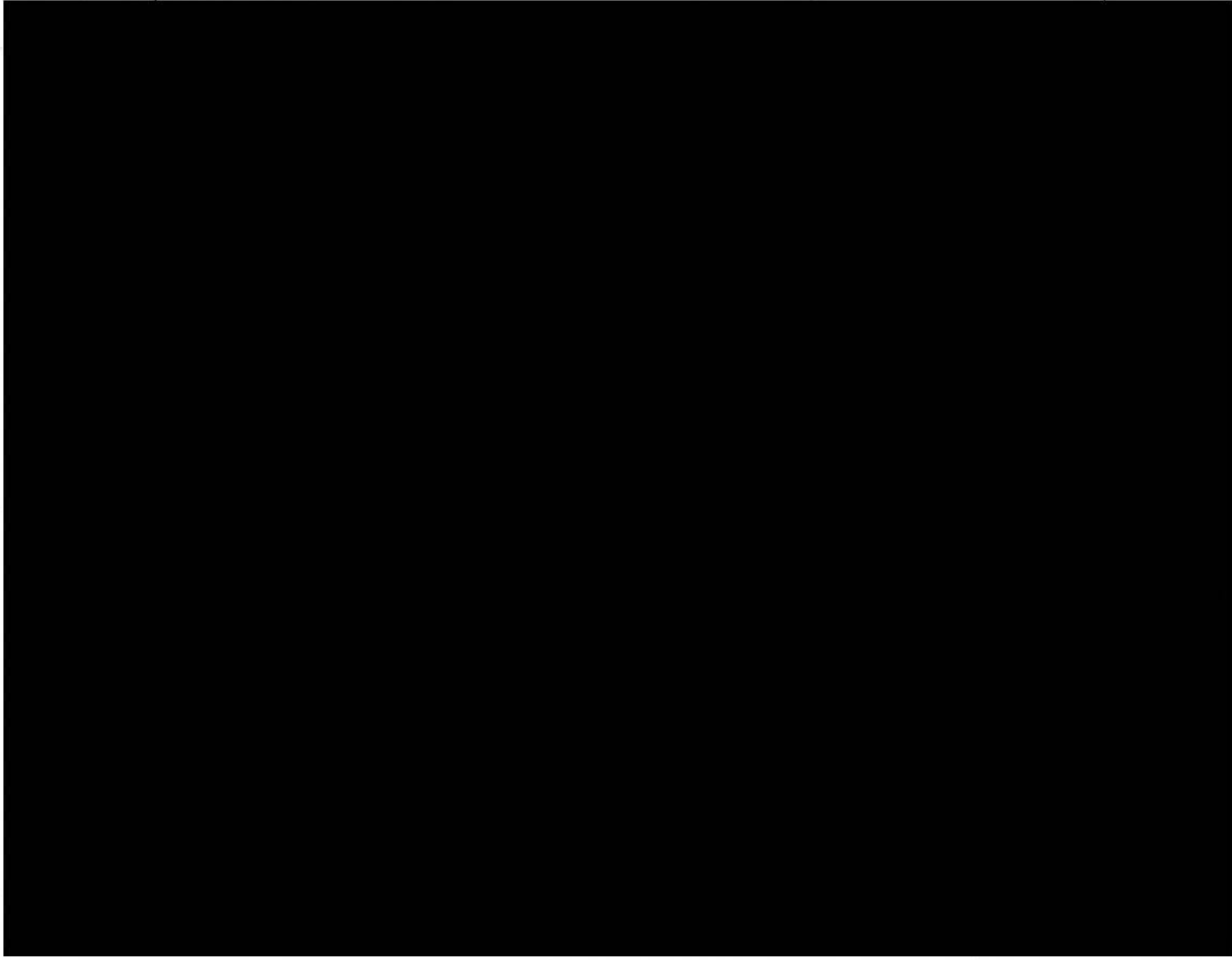

BOOKING APPROVED BY
M. Coiro 2733 SR.
SUPERVISOR/ID#

Ventura County Sheriff's Department
Detention Services
PreBook Booking Sheet

Inmate's File

Canley, Adrian Doyle



Arrest Date/Time:	09/22/2006 11:00	Booking Nbr:	
Reception Date/Time:		Sheriff's BI Nbrs:	
Master Date/Time:			
Booking Cash:	\$0.00		

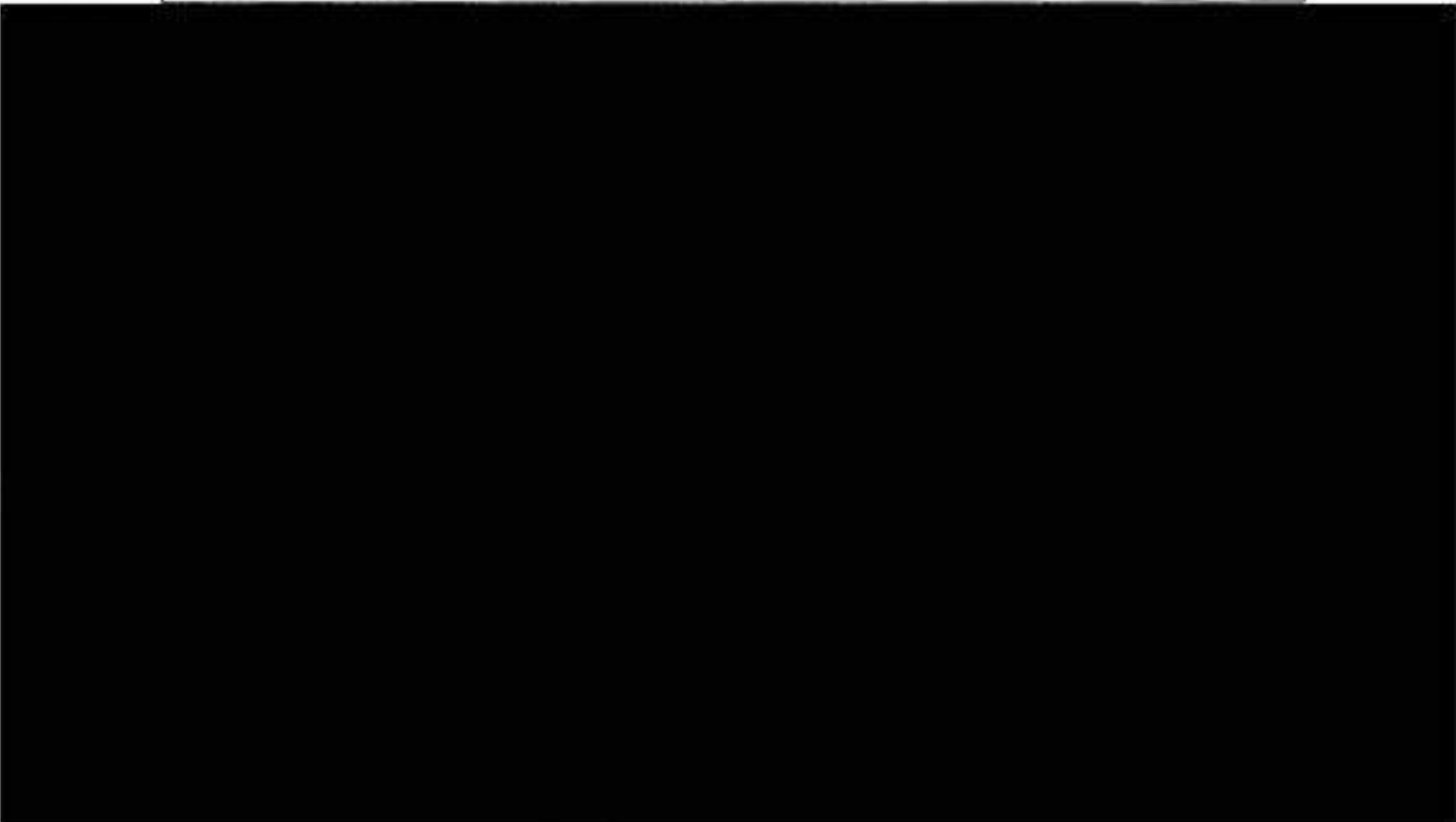

VENTURA COUNTY SHERIFF'S DEPARTMENT * CUSTODY DIVISION
INTAKE HEALTH SCREENING

2733
SP

Inmate Name CANLEY, ADRIAN

DOB _____

Booking Number _____



MALE
 FEMALE

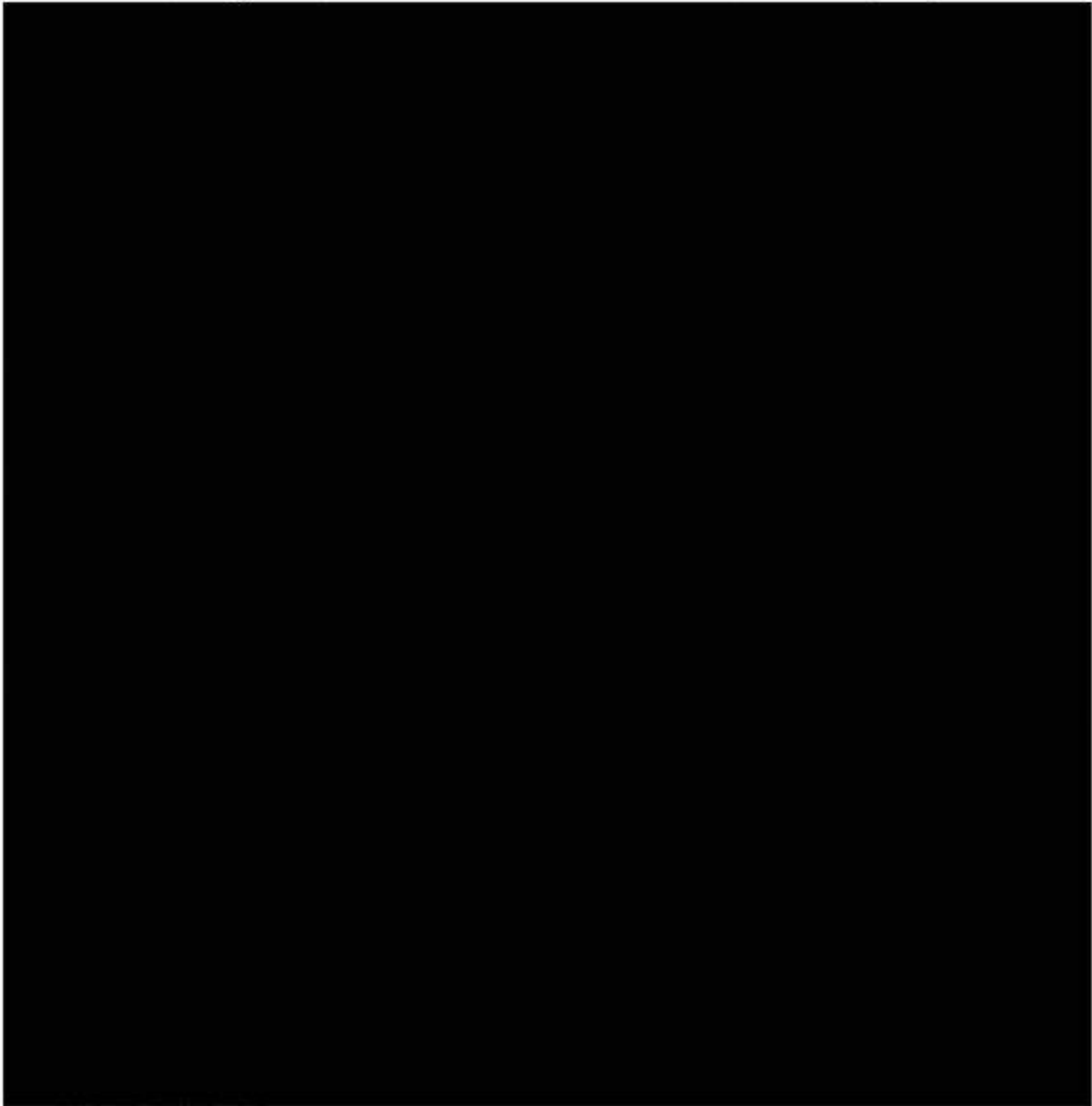

Medical Staff / Officer's Comments _____

Medical Staff's Signature / Date & Time

APPLICATION FOR BAIL/OWN RECOGNIZANCE (O.R.) RELEASE

ALL INFORMATION CONTAINED HEREIN IS UNCLASSIFIED

DATE 08-14-2011 BY 60322 UCBAW/STP

VENTURA COUNTY
SHERIFF'S DEPARTMENT



Reception Housing Clearance

Reception Housing Bypass

Name: CANLEY, ADRIAN

9/26

Booking: [REDACTED]

Class: L2

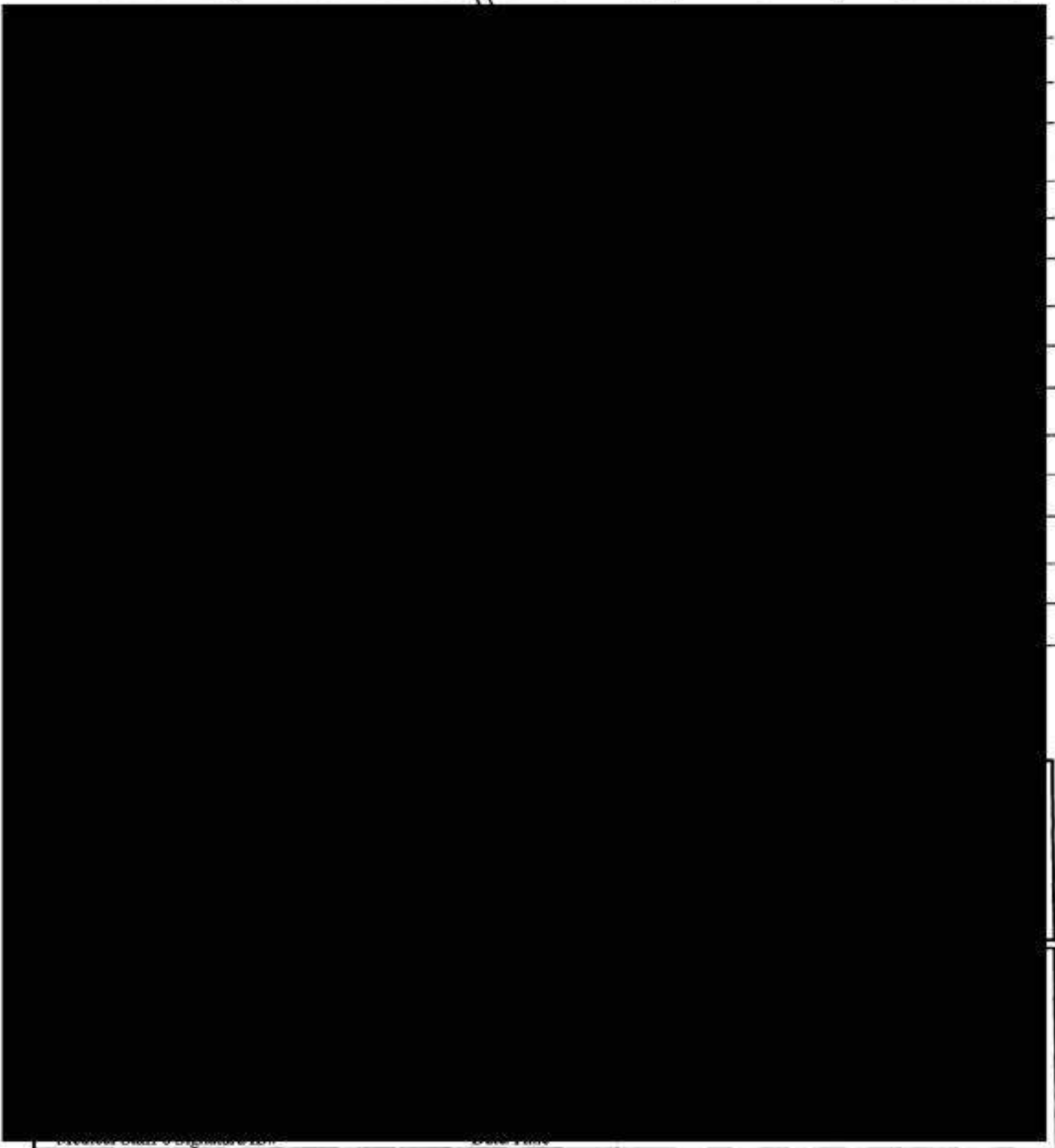

Ventura County Sheriff's Department
Detention Services
Master Booking Sheet



Canley, Adrian Doyle

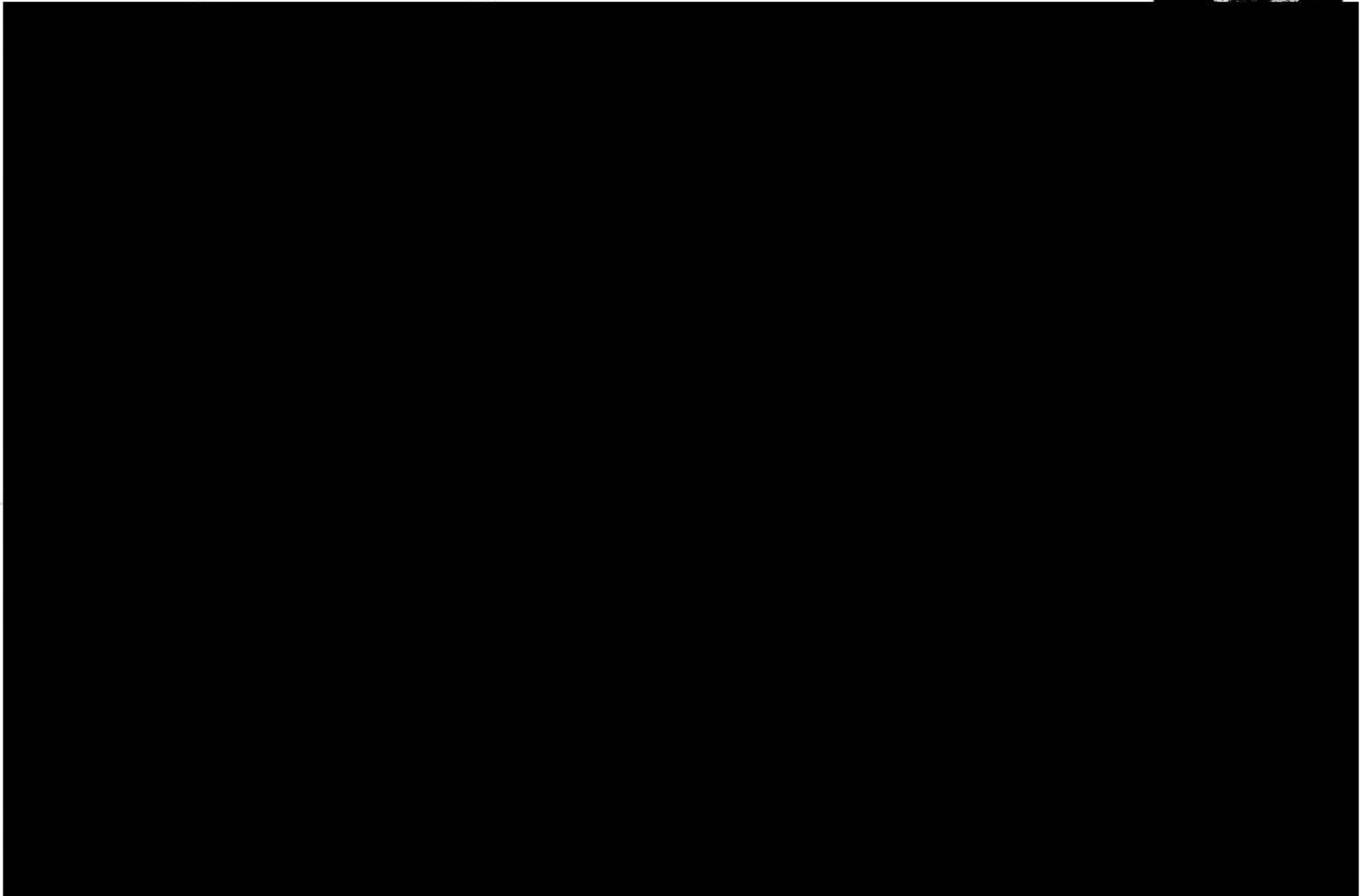

VENTURA COUNTY SHERIFF'S DEPARTMENT
DETENTION SERVICES
MC - Bill Ayub
DATE: 11/22/04

76/237
9-26-06/1812

**Ventura County Sheriff's Department
Detention Services
Master Booking Sheet**

Canley, Adrian Doyle

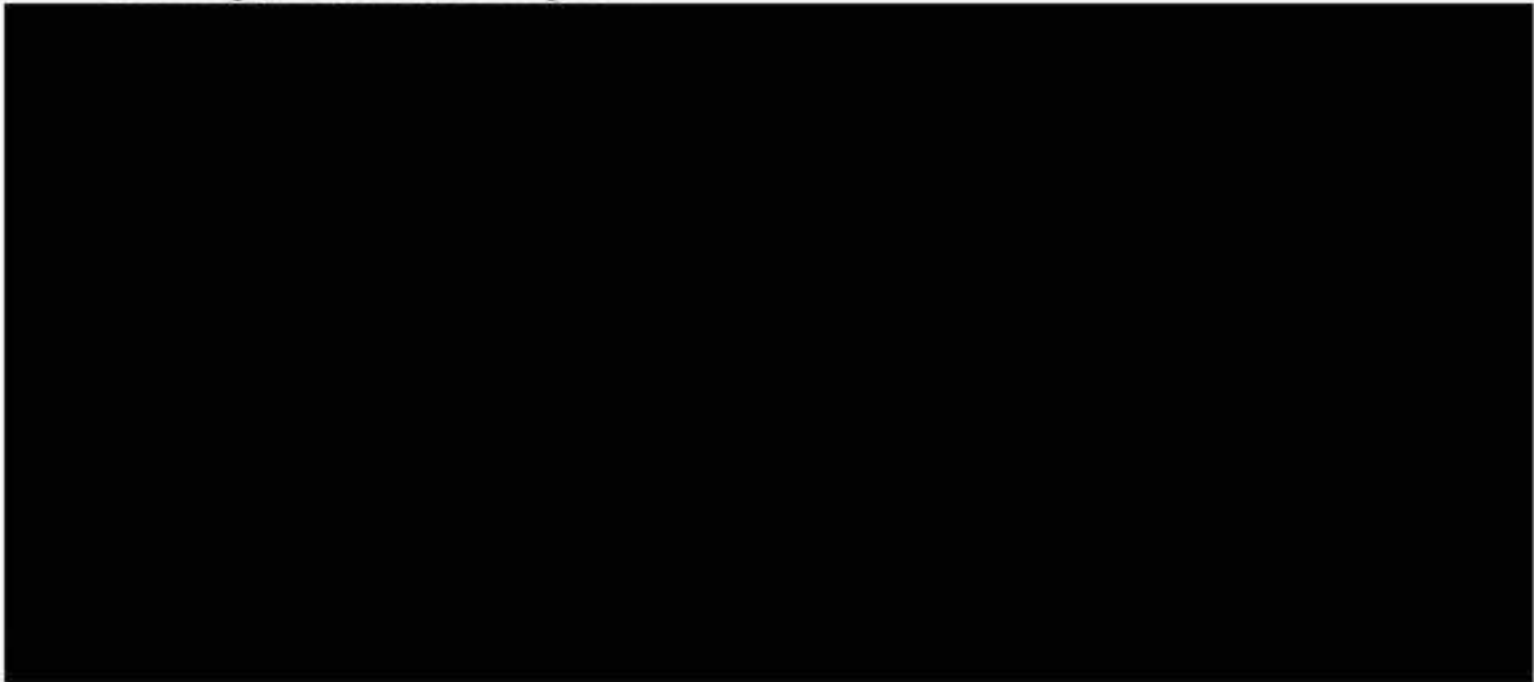

<u>Final Release</u>	Release Disposition <i>OK</i>		Bail Bond/BFR Number	
To Appear At	Court Date		Court Time	
Release To	Department		Release Approval <i>4/2m</i>	
Release Wrt. Check <i>4193</i>	Prepared By <i>4193</i>	Released By <i>4349</i>	Date <i>09-26-06</i>	Time <i>1947</i>

COMMITMENT ORDER

①

Case Number 2006036265

People Vs Canley, Adrian



Ventura County Sheriff's Department
Detention Services
Master Booking Sheet

Canley, Adrian Doyle

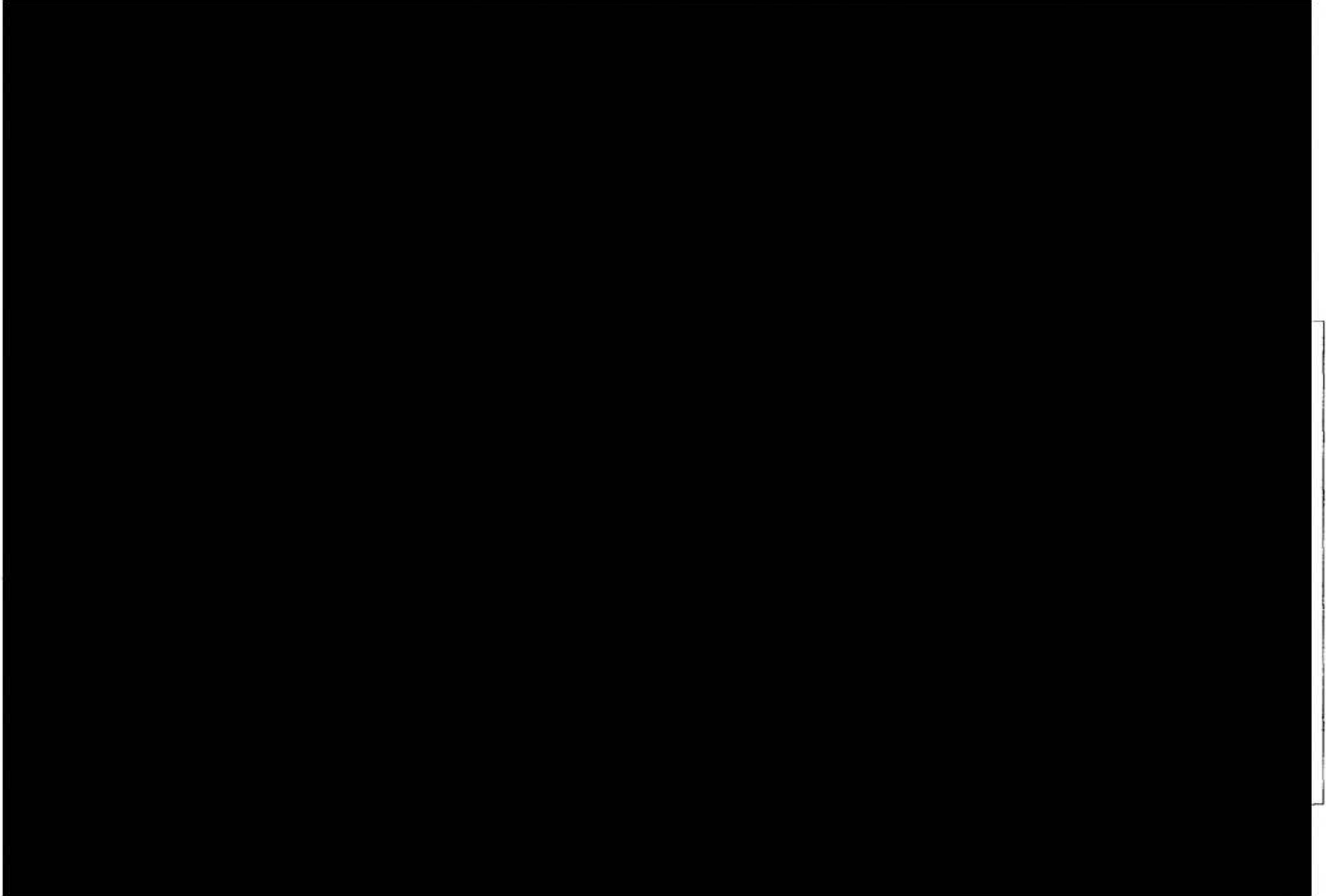

I understand my signature acknowledges the correctness of the information furnished by me.

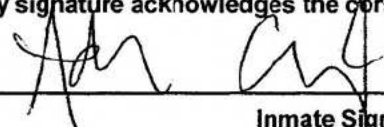
X  _____
Inmate Signature

**Ventura County Sheriff's Department
Detention Services**

Property Returned to Inmate at Release

Canley, Adrian Doyle

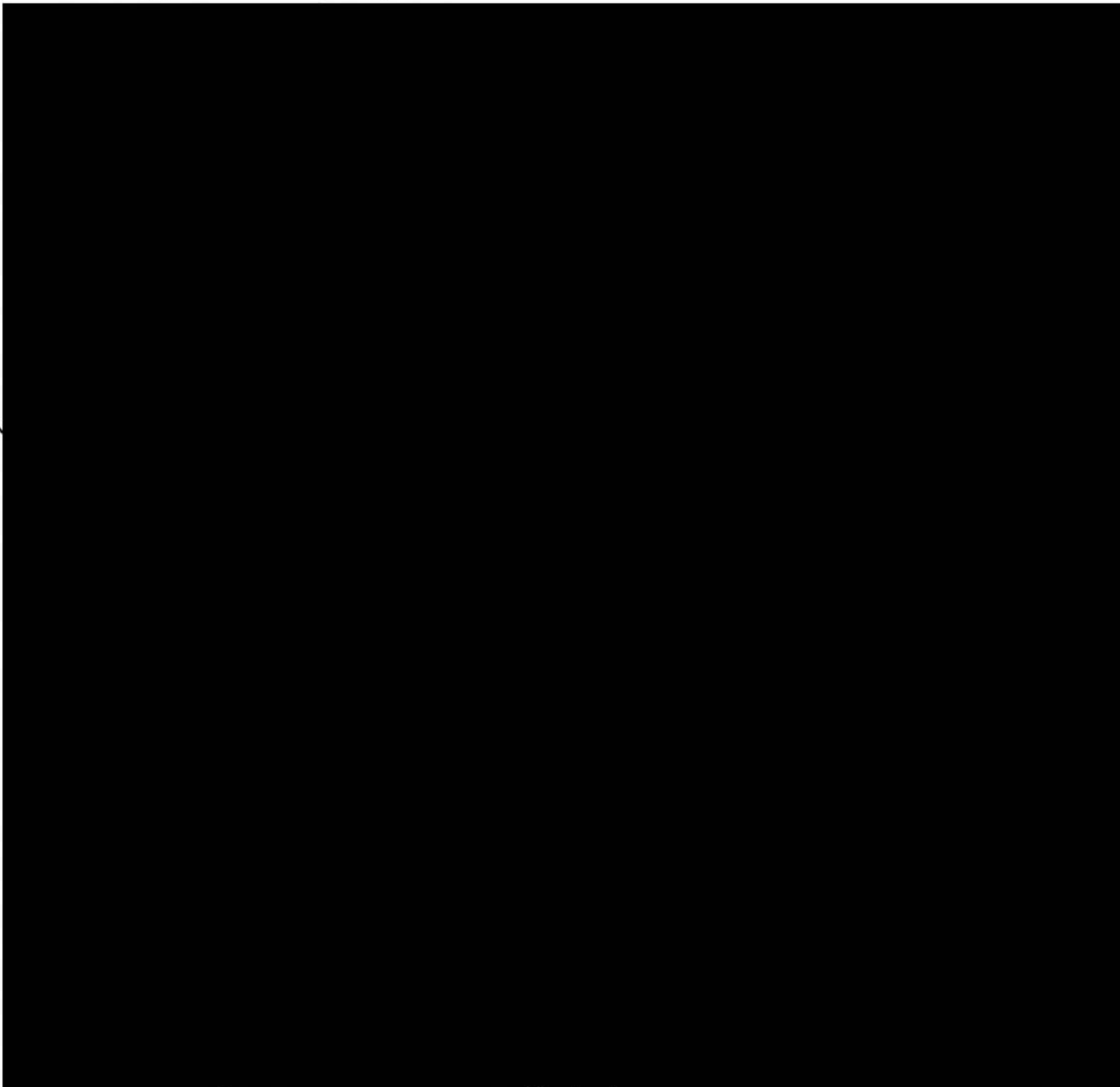

Fingerprint Card

Live Scan ID: H11 Mens Booking

Inmate Name: CANLEY, ADRIAN DOYLE

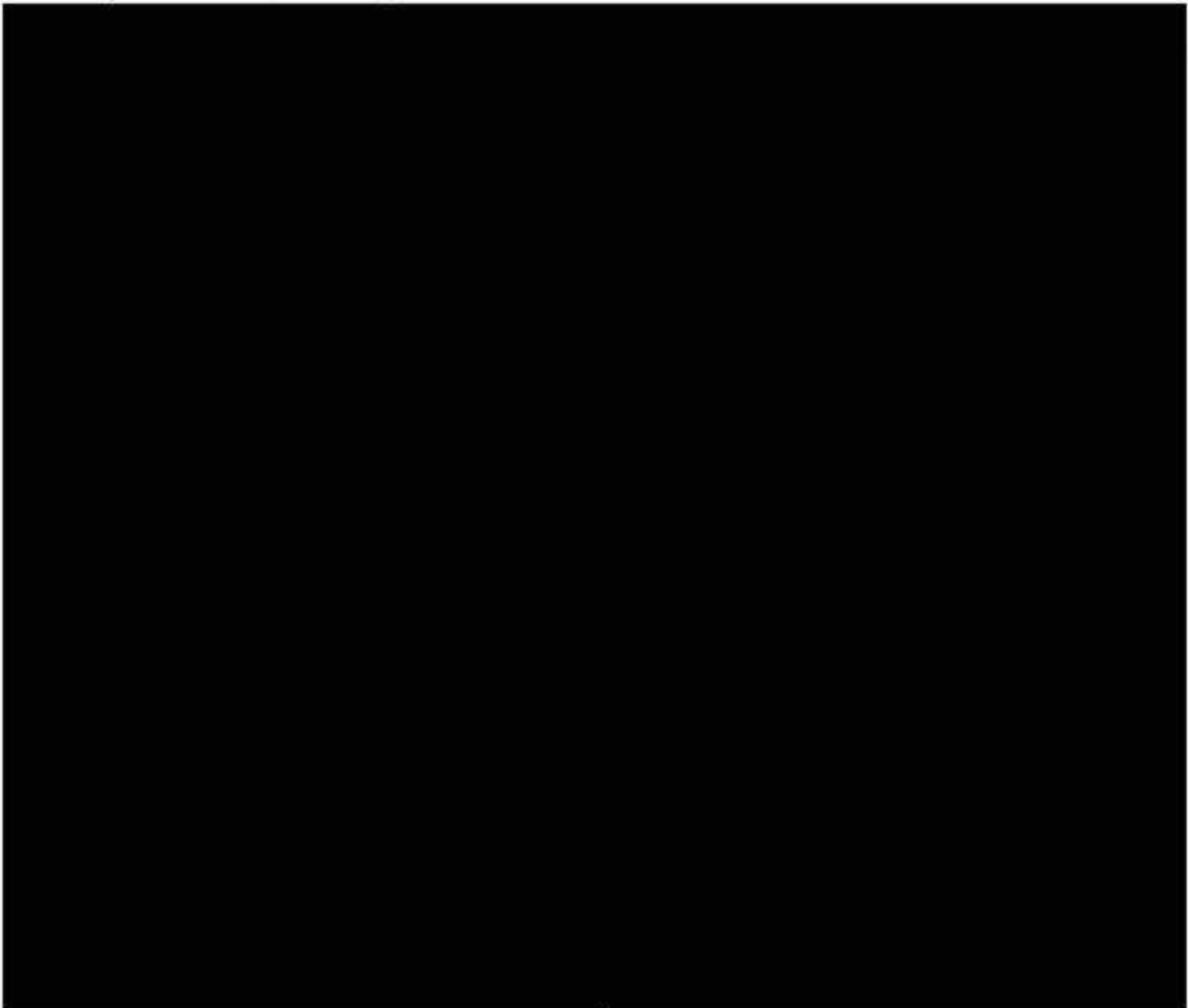

Flat Fingerprints

Right Hand at RELEASE

Flat Fingerprints

Right Hand at BOOKING

*Instructions: Place the full length of all four fingers on the right hand in the right box if they are being booked.
Use the left box if they are being released.*

Ventura County Sheriff's Department
Detention Services
PreBook Booking Sheet

4196

Inmate's File

Canley, Adrian Doyle

8-3-06



Ventura County Sheriff's Department
Detention Services
PreBook Booking Sheet

Inmate's File

Canley, Adrian Doyle

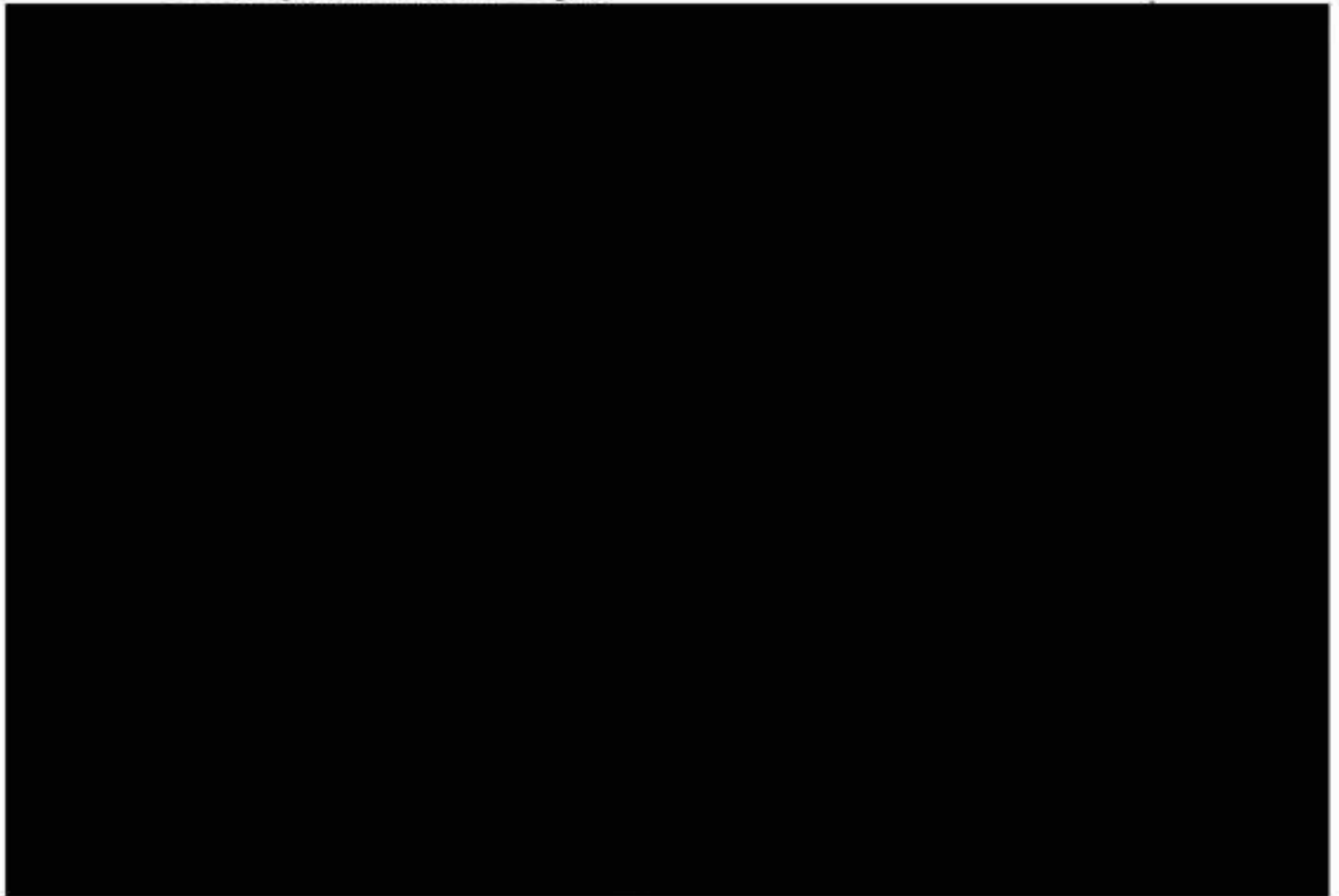

VENTURA COUNTY SHERIFF'S DEPARTMENT * CUSTODY DIVISION
INTAKE HEALTH SCREENING

MALE

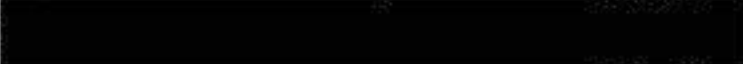
Inmate Name CANCEY, ADRIAN DOB 

OBSERVATIONS (Check Box)  YES NO

Medical Staff's Signature / Date & Time

APPLICATION FOR BAIL/OWN RECOGNIZANCE (O.R.) RELEASE

Please Print

P.D. 0172 E.V. M.J.

Booking No. [REDACTED]

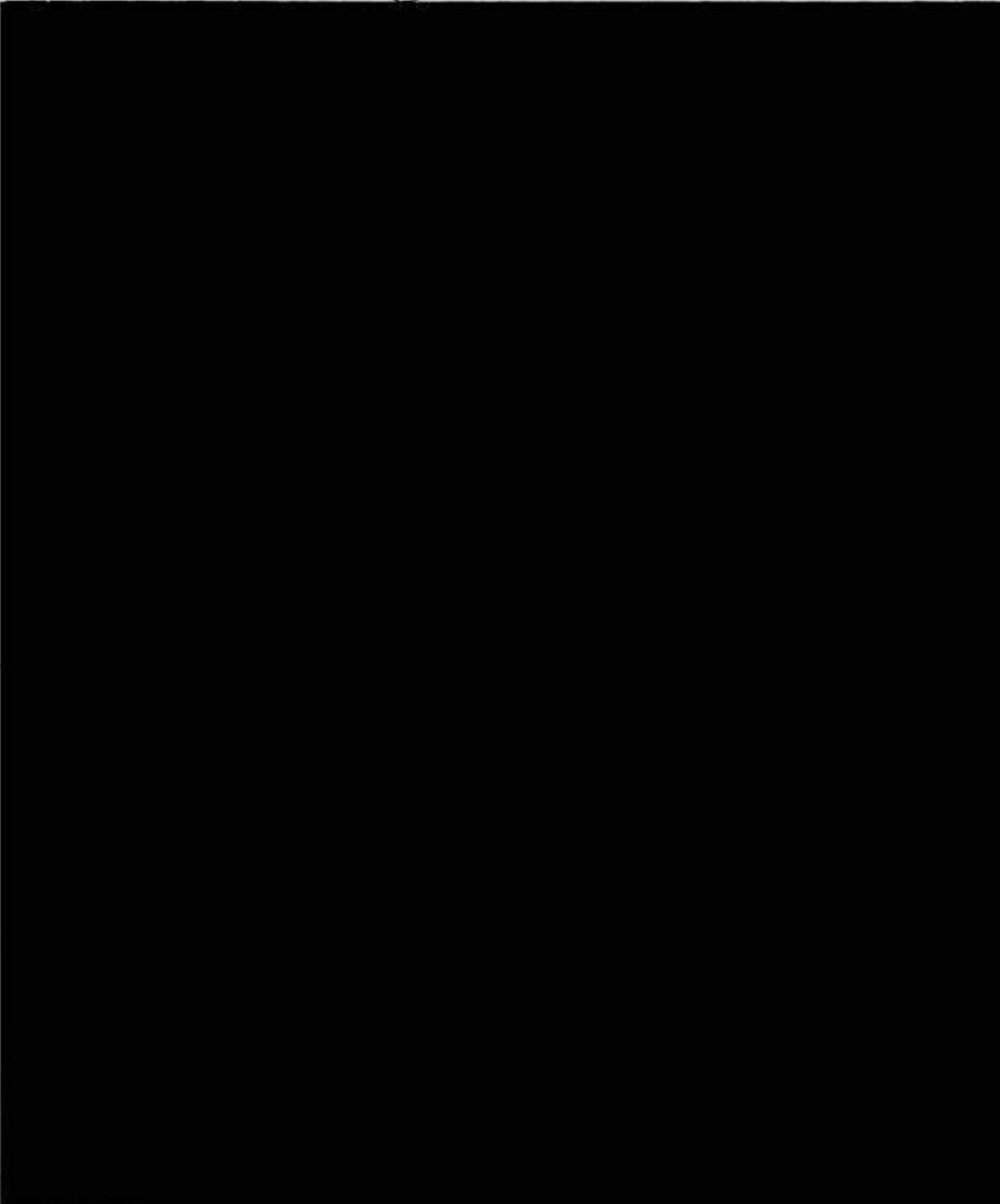

Ventura County Sheriff's Department
Detention Services
Master Booking Sheet

Canley, Adrian Doyle

VENTURA COUNTY SHERIFF
VENTURA BUREAU COPY.
RECORD BUREAU COPY.
NOT TO BE DUPLICATED
TO: MC-BILL AXUD
BY: CR
DATE: 11/27/06

0150
2510
2877

**Ventura County Sheriff's Department
Detention Services
Master Booking Sheet**

Canley, Adrian Doyle

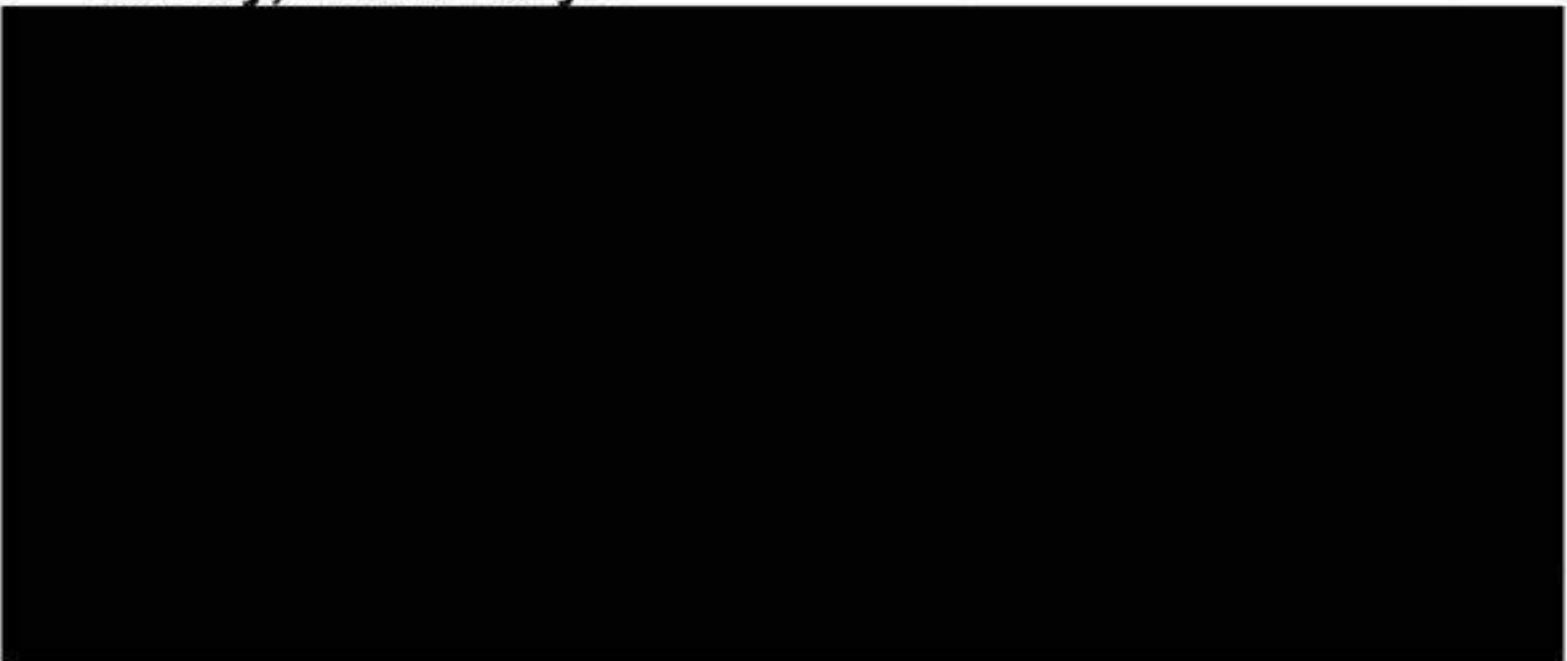

<u>Final Release</u>	Release Disposition <i>CR</i>		Bail Bond/BFR Number	
To Appear At <i>RM118</i>	Court Date <i>9-6-06</i>		Court Time <i>0815</i>	
Release To <i>SELF</i>	Department		Release Approval <i>[Signature]</i>	
Release Wrt. Check <i>[Signature]</i>	Prepared By <i>[Signature]</i>	Released By <i>[Signature]</i>	Date <i>8-3-06</i>	Time

Ventura County Sheriff's Department
Detention Services
Master Booking Sheet

Canley, Adrian Doyle

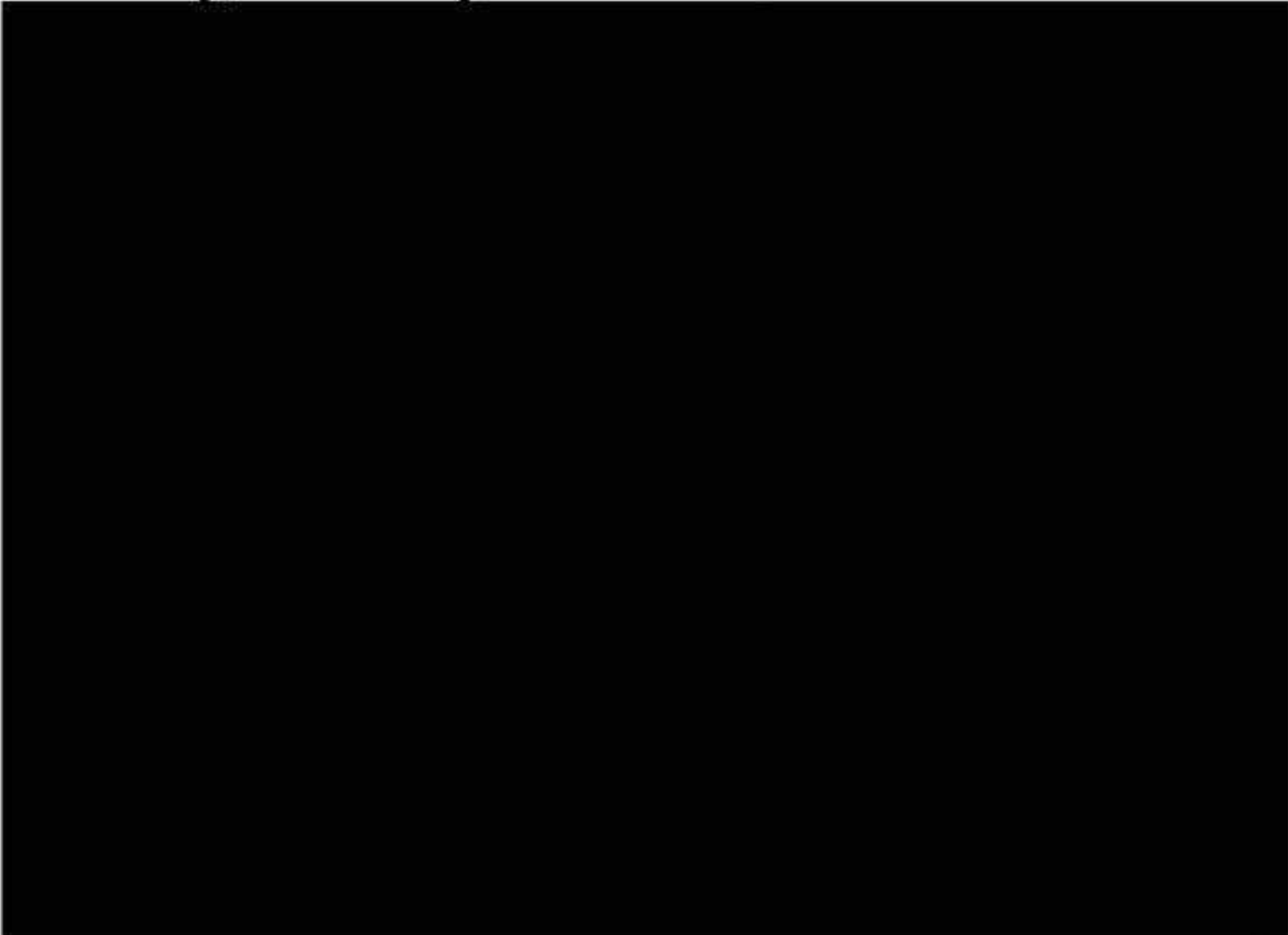

I understand my signature acknowledges the correctness of the information furnished by me.

X Adrian Doyle
Inmate Signature

Ventura County Sheriff's Department Detention Services

Property Returned to Inmate at Release

Canley, Adrian Doyle

Inmate Names			
Name (Last, First, Middle)	Name Type	DOB	Booking Number
Canley, Adrian Doyle	Primary Booking Name	[REDACTED]	[REDACTED]

Property Items

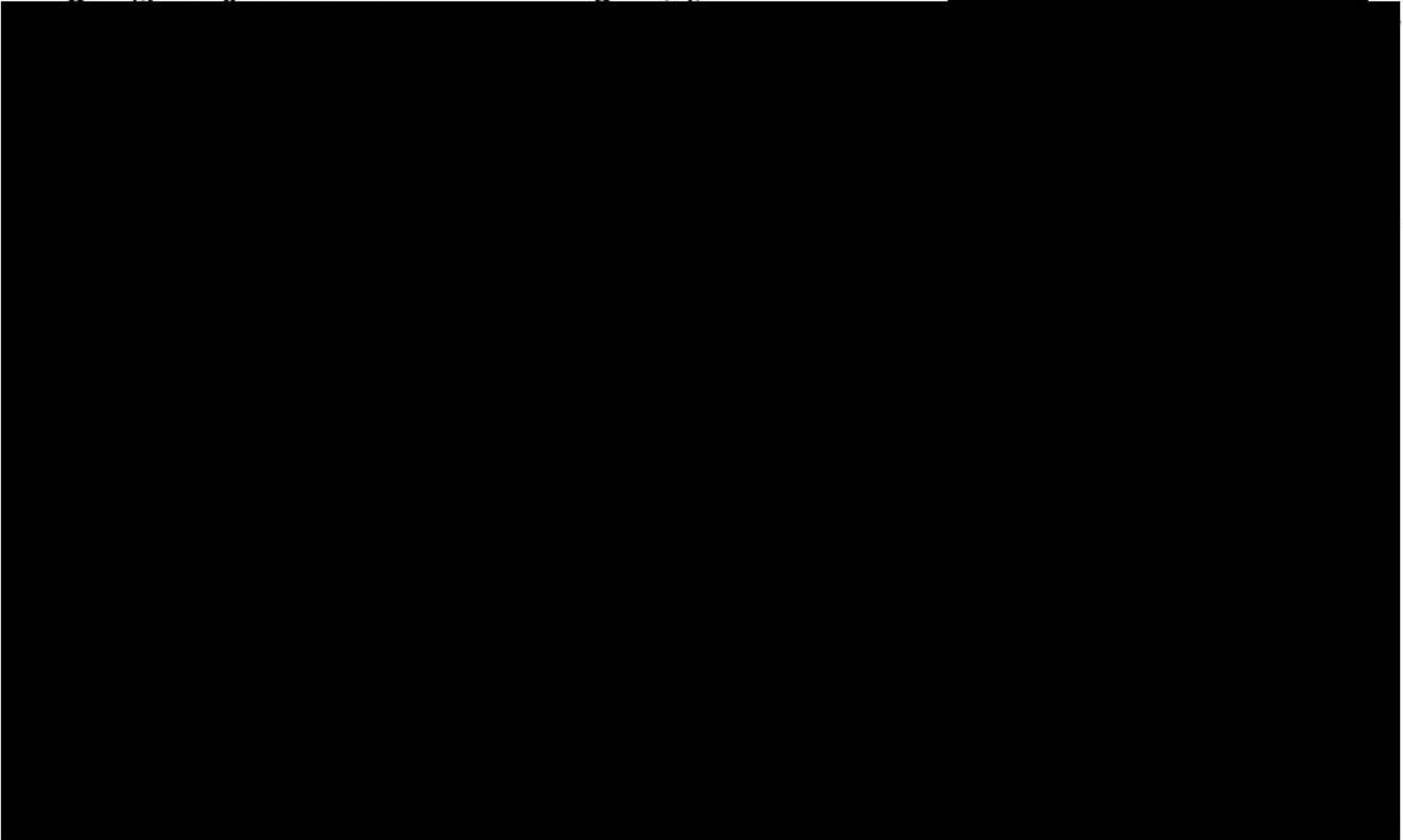

X 

Inmate Signature

08/03/2006

Date

X 

Signature and ID of officer releasing property

08/03/2006

Date

Employee 4028 - Rapske, K

Fingerprint Card

Live Scan ID: H11 Mens Booking

Inmate Name: CANLEY, ADEIAN DOYLE



Flat Fingerprints

Right Hand at RELEASE

Flat Fingerprints

Right Hand at BOOKING

*Instructions: Place the full length of all four fingers on the right hand in the right box if they are being booked.
Use the left box if they are being released.*

Ventura County Sheriff's Department
Detention Services
PreBook Booking Sheet

3029
C/CC

Inmate's File

Canley, Adrian Doyle



Booking App. by
J. Mitchell
Supervisor #

Ventura County Sheriff's Department
Detention Services
PreBook Booking Sheet

Inmate's File

Canley, Adrian Doyle



6
VENTURA COUNTY SHERIFF'S DEPARTMENT * CUSTODY DIVISION
INTAKE HEALTH SCREENING

Inmate Name Conley, Adrian J. Doyle DOB [REDACTED]

OBSERVATIONS (Check Box)

YES NO

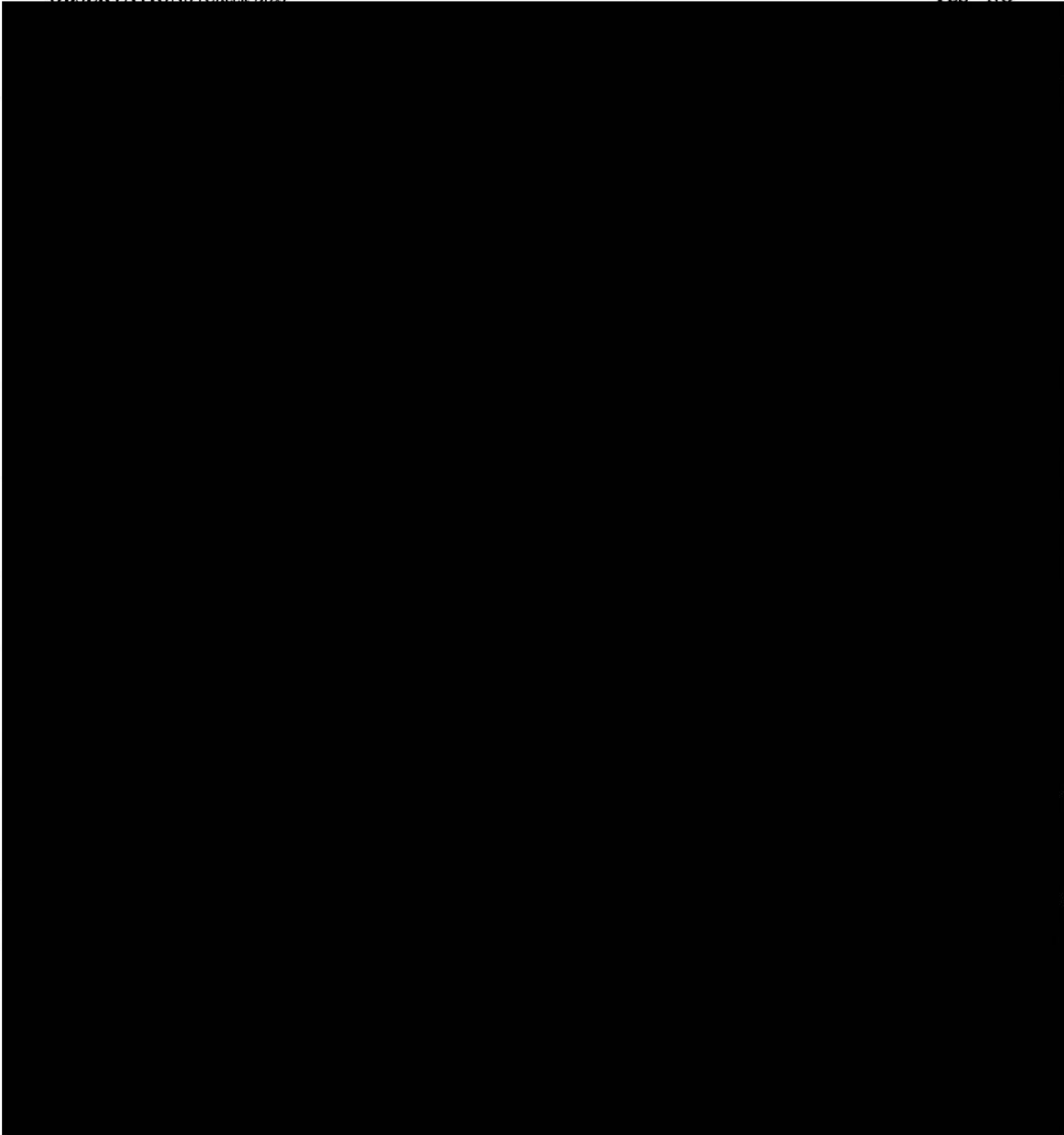

APPLICATION FOR BAIL/OWN RECOGNIZANCE (O.R.) RELEASE

Please Print

P.D. _____ E.V. M.J.

Booking No.

10945-25

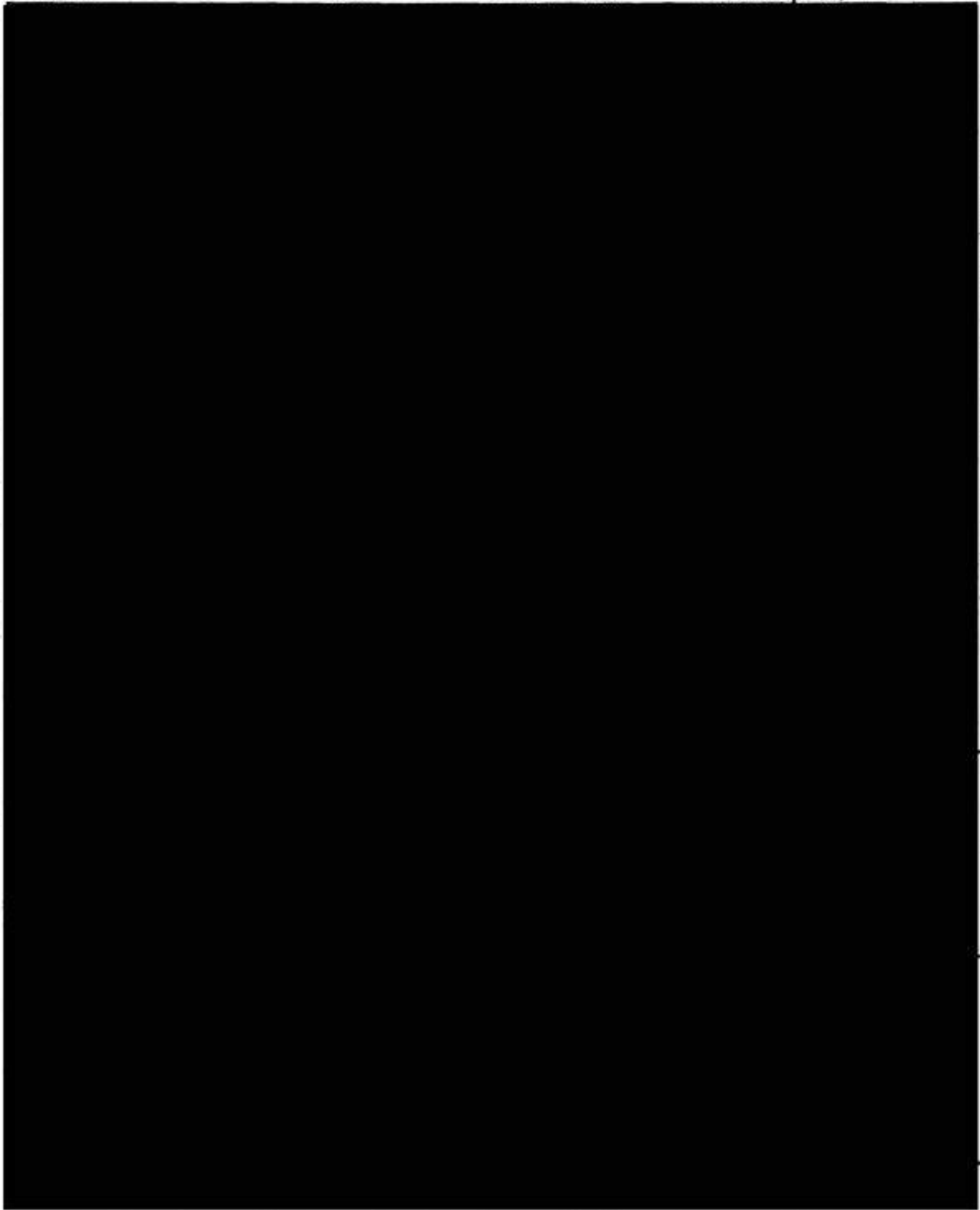

Ventura County Sheriff's Department
Detention Services
Master Booking Sheet



Canley, Adrian Doyle

VENTURA COUNTY SHERIFF
RECORD BUREAU COPY;
NOT TO BE DUPLICATED
FOR MC- BILL AYUB.
BY: CR
DATE: 11/22/06.

SGT
1507

**Ventura County Sheriff's Department
Detention Services
Master Booking Sheet**

Canley, Adrian Doyle

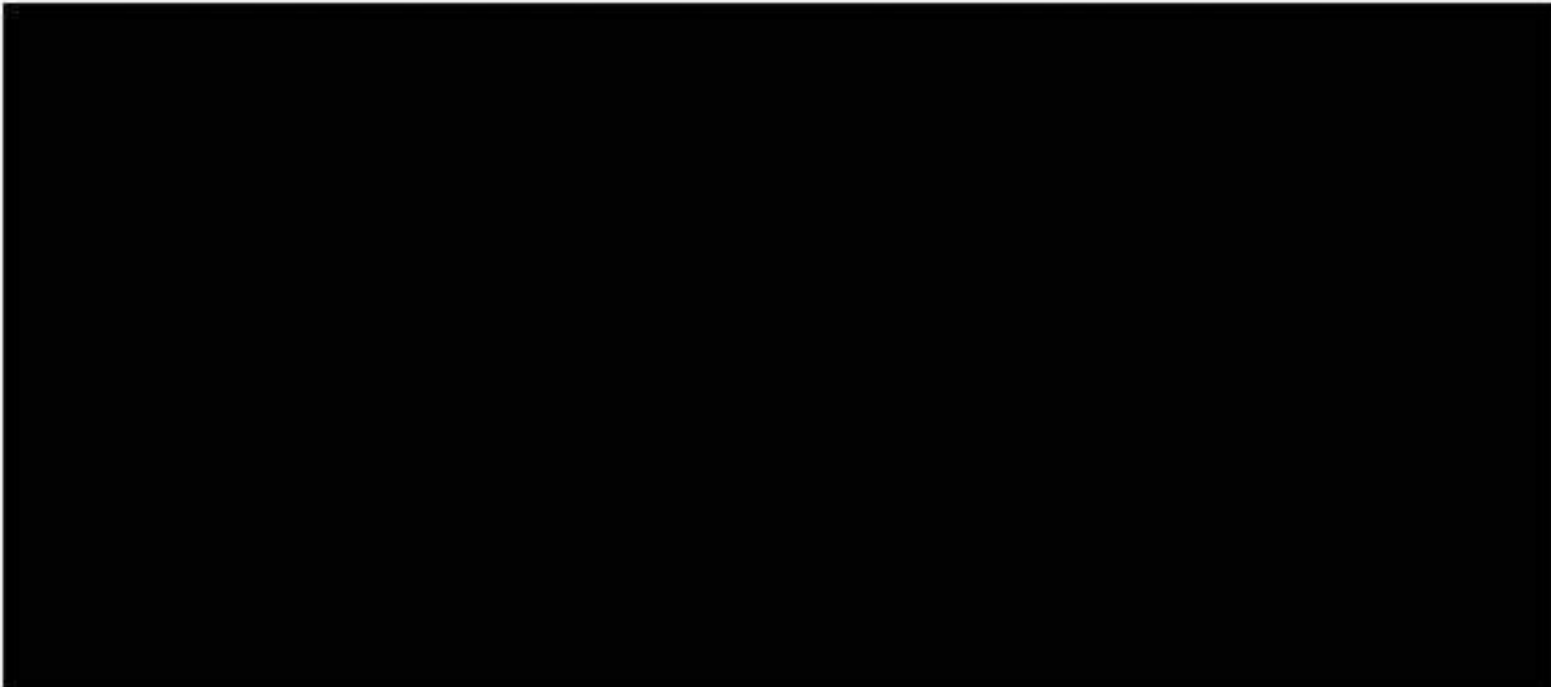

<u>Final Release</u>		Release Disposition CR		Bail Bond/BFR Number	
To Appear At RM-118		Court Date 07.24.06		Court Time 0815	
Release To		Department		Release Approval 289	
Release Wrt. Check 4096	Prepared By 4096	Released By 3852	Date 06.22.06	Time 1555	

Ventura County Sheriff's Department
Detention Services
Master Booking Sheet

Canley, Adrian Doyle

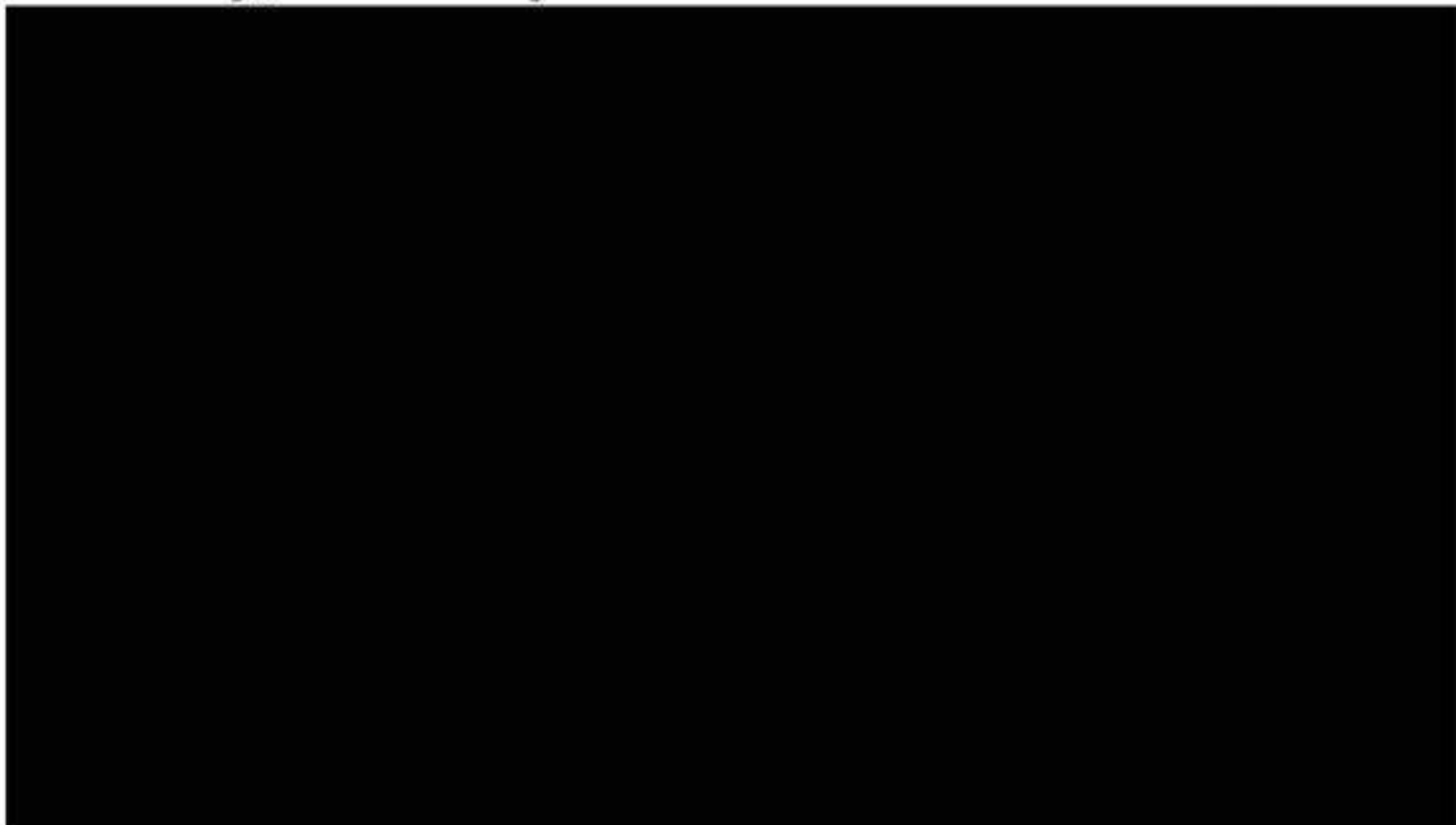

I understand my signature acknowledges the correctness of the information furnished by me.

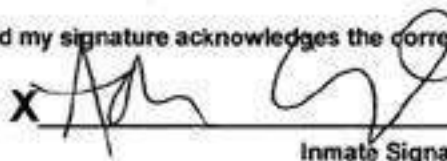
X  _____
Inmate Signature

**Ventura County Sheriff's Department
Detention Services**

Property Returned to Inmate at Release

Canley, Adrian Doyle

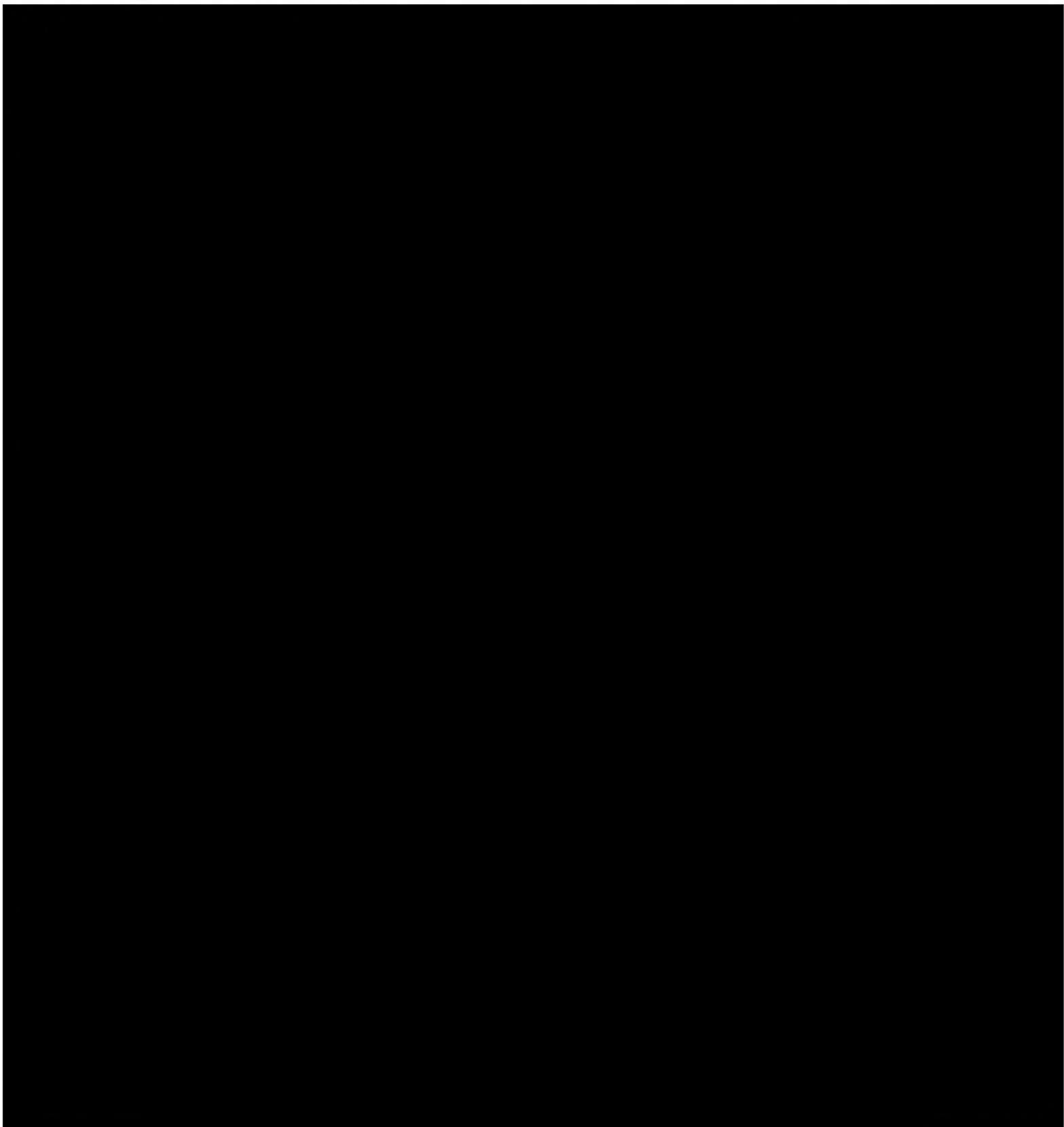

Fingerprint Card

Live Scan ID: H11 Mens Booking

Inmate Name: CANLEY, ADRIAN DOYLE

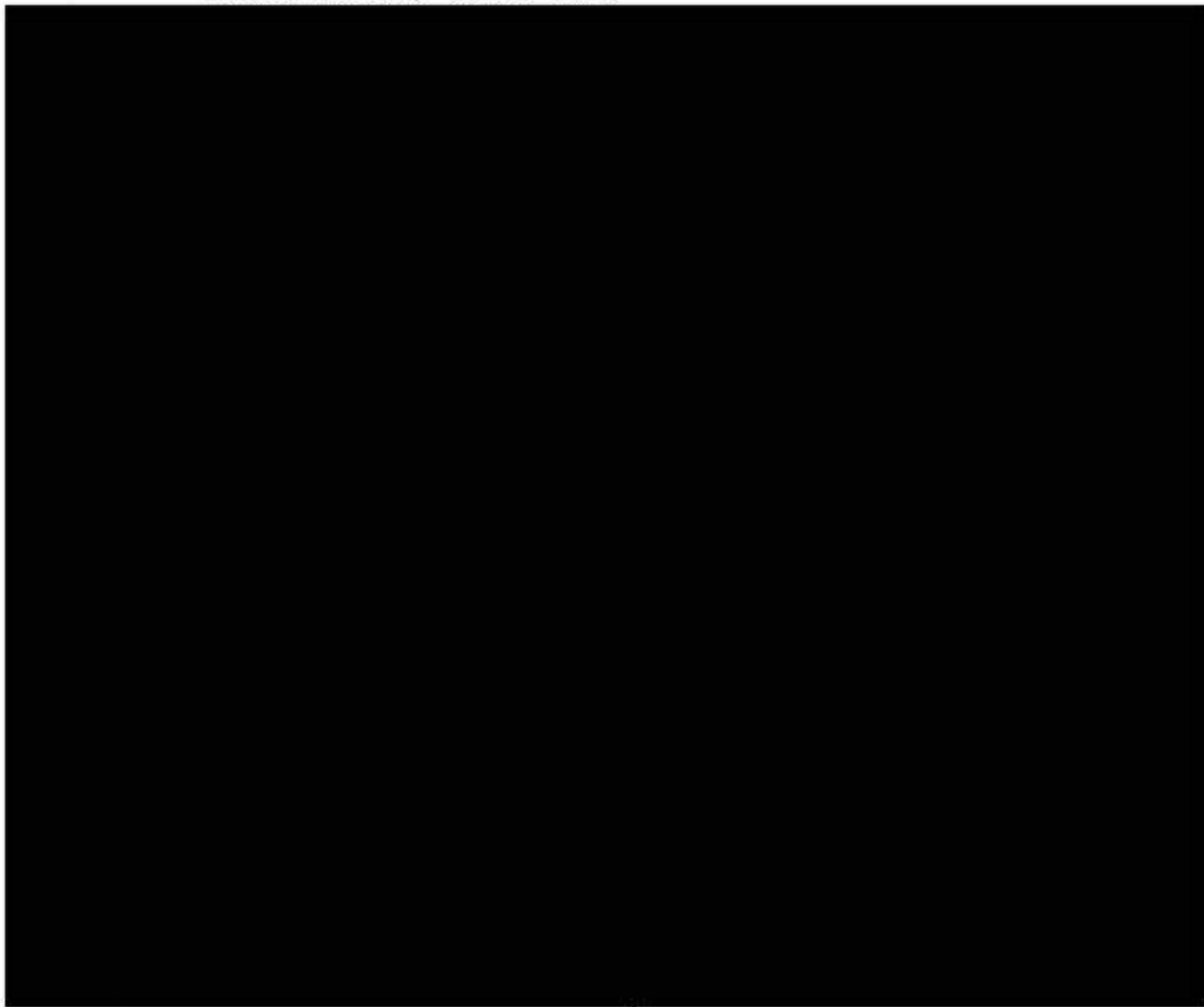

Flat Fingerprints

Right Hand at RELEASE

Flat Fingerprints

Right Hand at BOOKING

*Instructions: Place the full length of all four fingers on the right hand in the right box if they are being booked.
Use the left box if they are being released.*

**VENTURA COUNTY SHERIFF'S DEPARTMENT
BUREAU OF IDENTIFICATION**

R.D. 9072	BEAT 9601	SERVICE REQUEST	RB NUMBER 06-30492
OFFENSE / INCIDENT 245(C)(1) PC / AUN ON OFCR.		DATE / TIME OF INCIDENT 11/14/06 1820	LOCATION OF INCIDENT (STREET ADDRESS & CITY) [REDACTED]

PROCESS THE FOLLOWING ITEMS OF EVIDENCE FOR LATENTS (Include Item No. and Description):
CHECK HIGH POINT .45 CAL. PISTOL FOR PRINTS - IF ANY LATENTS ARE FOUND - COMPARE TO CANLEY. (CHECK MAGAZINE FOR LATENTS ALSO)

OFFICER: W. AYUS / 3318 AGENCY: V.C.S.D. PHONE: 477-7019

SUSPECT NAME (S)	D.O.B.	IN CUSTODY	* SHERIFF'S B.I. NO.	* C.I.I. NO.
CANLEY, ADRIAN	[REDACTED]	<input type="checkbox"/> YES <input checked="" type="checkbox"/> NO		
		<input type="checkbox"/> YES <input type="checkbox"/> NO		
		<input type="checkbox"/> YES <input type="checkbox"/> NO		
		<input type="checkbox"/> YES <input type="checkbox"/> NO		
TRIAL/HEARING DATE				

* B.I. No. or C.I.I. Required for Comparison Requests

RESULTS OF FINGERPRINT EXAMINATIONS (B.I. Use Only)

Latent Evaluation

- Item processed, (no prints found)
- Print(s) have insufficient detail
- Finger prints of possible value
- Palm Prints of possible value
- No latent prints in file

Comparison/Identification

- Print identification. (See Continuation Sheet)
- No fingerprints of suspect(s) available
- No palm prints of suspect(s) Available
- Prints compared with negative results
- Prints are not made by individuals compared
- Unable to compare-poor quality print card

CAL-ID

- Automated system hit
- Prints are insufficient for search
- Search with negative results
- Palm prints only, not searchable

Process(s) Used

- Dusted with:
- Black Powder
- Bichromatic Powder
- Fluorescent Powder
- Ninhydrin
- DFO
- Glue fuming
- Dye staining
- Other _____

B.I. OFFICER: BJ 3426 Johnson DATE: 11-24-06

Date Received: 11/24/06 Date Assigned: 11/24/06

VENTURA COUNTY SHERIFF'S FORENSIC SCIENCES LABORATORY

REQUEST FOR ANALYSIS

Accused/Suspect CANLEY, ADRIAN	DOB [REDACTED]	Victim/Person Reporting Offense	Offense 245(c)(1) PC - ADW on O.I.S. OFFICER
Investigating Agency VENTURA CO. SHERIFF		Investigating/Requesting Officer(s) W. AYUB	<input checked="" type="checkbox"/> New Case Additional Exhibits
Is Subject In Custody? DECEASED Yes; Date of Arrest _____ No		Date Of Offense 11/14/2006	Related Cases:
Telephone # 477-7019		Agency File Number 06-30492	
COURT INFORMATION		BLOOD ALCOHOL ONLY	
Court Number: _____	Date: _____	Date and time of blood draw _____	Geographic location _____
Is exam needed for juvenile court? Yes <input checked="" type="checkbox"/> No		Sterilizing agent used _____	CDL: _____
		Witnessing officer _____	Breath results: results _____ time _____
		Person drawing blood _____	results _____ time _____

Details Of Investigation (relevant portions of crime report may be attached)

CANLEY DROVE A MOTOR VEHICLE TOWARD A PLAIN-CLOTHES DETECTIVE. THE DETECTIVE FIRED AT CANLEY, STRIKING CANLEY AND HIS VEHICLE. CANLEY'S VEHICLE HAD TWO BULLET HOLES IN IT FROM AN UNRELATED INCIDENT.

Specific Examinations Requested

Circle Desired Tests

Alcohol Content Firearms Comparison Body Fluid Identification

Toxicological Analysis Operating Condition of Firearm DNA Testing

Shoe Print/Tire Track NIBIN Trace Evidence Examination

Other _____

Solid Dosage Drug Identification

DA Approval (Signature Required)

Is fingerprint processing requested? Yes No If yes, fill out BI service request

Have photographs been submitted? Yes No If yes, fill out Photo Lab request

AGENCY	LAB	DESCRIPTION AND SPECIFIC EXAM REQUESTED
Item #	Item #	Exhibits (List items individually, use an additional form if required)

1	2	3	DESCRIPTION AND SPECIFIC EXAM REQUESTED	NIK TEST RESULTS (Drugs Only)
internal use only			EXAMPLE: ALCOHOL CONTENT ON BLOOD SAMPLE FROM JOHN DOE	
			EXAMPLE: DNA ON BLOOD STAINED PIECE OF PAPER FROM CRIME SCENE, COMPARE WITH SUSPECT'S STANDARD	
			EXAMPLE: OPERATING CONDITION ON 357 MAGNUM, ENTER INTO NIBIN	
			HIGHPOINT .45 CAL PISTOL - CHECK FUNCTION, COMPARE TO PROJECTILE RECOVERED FROM PICKUP TAILGATE - PHOTO THOROUGHLY - ENTER IN NIBIN	
			SIG SAUER .40 CAL PISTOL - CHECK FUNCTION, EJECTION PATTERN ANALYSIS, COMPARE TO PROJECTILES RECOVERED AS EVIDENCE, PHOTO THOROUGHLY, CHECK FOR DAMAGE TO MUZZLE OR FRONT SIGHT CAUSED FROM PISTOL STRIKING A WINDOW.	

Evidence booked into Property by _____	FOR INTERNAL USE ONLY	
Date _____ Time _____	LABORATORY NUMBER CASE ASSIGNED TO DATE	Barcode Here

PROPERTY / EVIDENCE REPORT

VENTURA COUNTY SHERIFF'S DEPARTMENT
AGENCY IDENTIFIER CA0560000

1 CONNECTING REPORT NUMBERS	2 RD 9072	3 BEAT 9G01	4 RB NUMBER 06 - 30492
-----------------------------	--------------	----------------	----------------------------------

5 INCIDENT / OFFENSE(S) (List all probable cause offenses pertaining to this RB.) OFFICER INVOLVED SHOOTING	6 <input type="checkbox"/> Misdemeanor <input type="checkbox"/> Felony	7 DATE OF INCIDENT 11-14-06
---	---	--------------------------------

ADDRESS AND CITY [REDACTED] THOUSAND OAKS	9 STOLEN PROPERTY VALUE TOTAL
--	-------------------------------

CODE: V - Victim S - Suspect A - Arrestee F - Finder O - Owner R - Reporting Party

10 CODE V	11 NAME (Last, First, Middle, Gen.) / FIRM NAME MATTHEWS, SHANE	AKA/Moniker [REDACTED]	15 BUSINESS PHONE -- / --
--------------	--	---------------------------	------------------------------

16 RESIDENCE ADDRESS / (<input type="checkbox"/> Same as Box # _____)	CITY	STATE	ZIP	17 RESIDENCE PHONE -- / --
---	------	-------	-----	-------------------------------

18 CODE S	19 NAME (Last, First, Middle, Gen.) / FIRM NAME CANLEY, ADRIAN DOYLE	AKA/Moniker [REDACTED]	23 BUSINESS PHONE -- / --
--------------	---	---------------------------	------------------------------

24 RESIDENCE ADDRESS / (<input type="checkbox"/> Same as Box # _____)	CITY	STATE	ZIP	25 RESIDENCE PHONE -- / --
---	------	-------	-----	-------------------------------

26 CODE	27 NAME (Last, First, Middle, Gen.) / FIRM NAME	AKA/Moniker	28 RACE	29 SEX	30 DOB	31 BUSINESS PHONE /
---------	---	-------------	---------	--------	--------	------------------------

32 RESIDENCE ADDRESS / (<input type="checkbox"/> Same as Box # _____)	CITY	STATE	ZIP	33 RESIDENCE PHONE /
---	------	-------	-----	-------------------------

34 NARRATIVE

Narrative on p5.

128 images were downloaded.

PROPERTY / EVIDENCE INFORMATION
For Bicycles, include the type (boy's, girl's, road, BMX, etc), frame size (inches), wheel size (inches), number of gears and brake policy in the Additional Information field.

35 LOCATION BOOKED <input checked="" type="checkbox"/> CRIME LAB <input type="checkbox"/>	36 SEARCH WARRANT? <input type="checkbox"/> Yes <input checked="" type="checkbox"/> No	37 FINDER WISHES TO CLAIM? <input type="checkbox"/> Yes <input checked="" type="checkbox"/> No
---	--	--

39 PROPERTY CLASSIFICATION CODES SP - STOLEN PROPERTY LP - LOST PROPERTY SR - STOLEN / RECOVERED RC - RECOVERED PROPERTY E - EVIDENCE RP - FOUND PROPERTY SK - SAFEKEEPING T - TRANSACTION	PROPERTY CODES A - CURRENCY / NOTES D - VEHICLES G - FIREARMS J - LIVESTOCK B - JEWELRY / PRECIOUS METALS E - OFFICE EQUIPMENT H - HOUSEHOLD GOODS K - MISCELLANEOUS C - CLOTHING / FURS F - ELECTRONIC EQUIPMENT I - CONSUMABLE GOODS L - BIKE <small>NOTE: ALL VEHICLES SHOULD ALSO BE ENTERED ON A CHP100 REPORT</small>
---	---

CODES E	ITEM # K	QTY 1	ITEM NAME TRUCK	MAKE FORD	MODEL / CALIBER F-150 WHITE	PROPERTY ROOM USE ONLY
PROP AFFILIATION S				VALUE		

ADDITIONAL INFORMATION
SUSPECT VEHICLE

CODES E	ITEM # K	QTY 1	ITEM NAME KEYS	MAKE	MODEL / CALIBER	PROPERTY ROOM USE ONLY
PROP AFFILIATION S				D / SERIAL NUMBER		
ADDITIONAL INFORMATION REMOVED FROM IGNITION OF TRUCK (ITEM 1)						

38 DATE AND TIME OF REPORT 11.15.06 2100	40 REPORTING OFFICER / ID NO. / DIV / UNIT [REDACTED] 3322 / Spec. Serv. / Crime Scene Inv. Unit
---	---

41 FTO OFFICER / ID NO. / DIV / UNIT	43 APPROVED BY / ID NO. / UNIT [Signature]
--------------------------------------	---

PROPERTY / EVIDENCE REPORT (continued)

VENTURA COUNTY SHERIFF'S DEPARTMENT
AGENCY IDENTIFIER CA0560000

4 RB NUMBER

06 - 30492

PROPERTY CLASSIFICATION CODES

SP - STOLEN PROPERTY
SR - STOLEN / RECOVERED
E - EVIDENCE
SK - SAFEKEEPING
LP - LOST PROPERTY
RG - RECOVERED PROPERTY
FP - FOUND PROPERTY
T - TRANSACTION

PROPERTY CODES

A - CURRENCY / NOTES
B - JEWELRY / PRECIOUS METALS
C - CLOTHING / FURS
D - VEHICLES
E - OFFICE EQUIPMENT
F - ELECTRONIC EQUIPMENT
G - FIREARMS
H - HOUSEHOLD GOODS
I - CONSUMABLE GOODS
J - LIVESTOCK
K - MISCELLANEOUS
L - BPG

CODES E K	ITEM # 3	QTY 5	ITEM NAME EMPTY CASINGS	MAKE SPEER	MODEL / CALIBER 40 s&w	PROPERTY ROOM USE ONLY
PROP AFFILIATION			ID / SERIAL NUMBER		VALUE	
ADDITIONAL INFORMATION PM 1-4, B						

CODES E K	ITEM # 3	QTY 3	ITEM NAME BULLET FRAGMENTS	MAKE	MODEL / CALIBER	PROPERTY ROOM USE ONLY
PROP AFFILIATION			ID / SERIAL NUMBER		VALUE	
ADDITIONAL INFORMATION PM 5-7						

CODES E K	ITEM # 3	QTY 1	ITEM NAME BULLET	MAKE	MODEL / CALIBER	PROPERTY ROOM USE ONLY
PROP AFFILIATION			ID / SERIAL NUMBER		VALUE	
ADDITIONAL INFORMATION PM 11						

CODES E K	ITEM # 4	QTY 1	ITEM NAME NOTEBOOK & CD	MAKE	MODEL / CALIBER	PROPERTY ROOM USE ONLY
PROP AFFILIATION			ID / SERIAL NUMBER		VALUE	
ADDITIONAL INFORMATION PM 10						

CODES E K	ITEM # 5	QTY 1	ITEM NAME HANDGUN	MAKE HI-POINT	MODEL / CALIBER JHP45ACP	PROPERTY ROOM USE ONLY
PROP AFFILIATION			ID / SERIAL NUMBER		VALUE	
ADDITIONAL INFORMATION PM 12						

CODES E K	ITEM # 6	QTY 1	ITEM NAME WALLET	MAKE	MODEL / CALIBER	PROPERTY ROOM USE ONLY
PROP AFFILIATION			ID / SERIAL NUMBER		VALUE	
ADDITIONAL INFORMATION PM 12						

CODES E A	ITEM # 7	QTY -	ITEM NAME US CURRENCY	MAKE	MODEL / CALIBER	PROPERTY ROOM USE ONLY
PROP AFFILIATION			ID / SERIAL NUMBER		VALUE \$ 686.00	
ADDITIONAL INFORMATION REMOVED FROM ITEM 6						

39 DATE AND TIME OF REPORT 11-15-06 2100				40 REPORTING OFFICER / ID NO. / DIV / UNIT [Redacted] / 3322 / Spec. Serv. / Crime Scene Inv. Unit			
41 FTO OFFICER / ID NO. / DIV / UNIT				42 APPROVED BY / ID NO. / UNIT Sgt. Obel [Signature]			

PROPERTY / EVIDENCE REPORT (continued)

VENTURA COUNTY SHERIFF'S DEPARTMENT
AGENCY IDENTIFIER CA0560000

4. R# NUMBER

06 - 30492

PROPERTY CLASSIFICATION CODES

SP - STOLEN PROPERTY
SR - STOLEN / RECOVERED
E - EVIDENCE
SK - SAFKEEPING
LP - LOST PROPERTY
RC - RECOVERED PROPERTY
FP - FOUND PROPERTY
T - TRANSACTION

PROPERTY CODES

A - CURRENCY / NOTES
B - JEWELRY / PRECIOUS METALS
C - CLOTHING / FURS
D - VEHICLES
E - OFFICE EQUIPMENT
F - ELECTRONIC EQUIPMENT
G - FIREARMS
H - HOUSEHOLD GOODS
I - CONSUMABLE GOODS
J - LIVESTOCK
K - MISCELLANEOUS
L - BKE

CODES E C	ITEM # 8	QTY 1	ITEM NAME PANTS	MAKE	MODEL / CALIBER BLACK	PROPERTY ROOM USE ONLY
PROP AFFILIATION S			ID / SERIAL NUMBER		VALUE	
ADDITIONAL INFORMATION PM 12						

CODES E K	ITEM # 9	QTY 2	ITEM NAME CELL PHONE + LIGHTER	MAKE	MODEL / CALIBER	PROPERTY ROOM USE ONLY
PROP AFFILIATION S			ID / SERIAL NUMBER		VALUE	
ADDITIONAL INFORMATION PM 13						

CODES E K	ITEM # 10	QTY 3	ITEM NAME 2 GLOVES + 1 GLASS PIPE	MAKE	MODEL / CALIBER	PROPERTY ROOM USE ONLY
PROP AFFILIATION S			ID / SERIAL NUMBER		VALUE	
ADDITIONAL INFORMATION PM 14						

CODES E C	ITEM # 11	QTY 1	ITEM NAME UNDERWEAR	MAKE	MODEL / CALIBER BOXER STYLE	PROPERTY ROOM USE ONLY
PROP AFFILIATION S			ID / SERIAL NUMBER		VALUE	
ADDITIONAL INFORMATION PM 15						

CODES E A	ITEM # 12	QTY -	ITEM NAME US COIN	MAKE	MODEL / CALIBER	PROPERTY ROOM USE ONLY
PROP AFFILIATION			ID / SERIAL NUMBER		VALUE \$.60	
ADDITIONAL INFORMATION PM 15						

CODES E K	ITEM # 13	QTY 1	ITEM NAME PARKING STICKER	MAKE	MODEL / CALIBER	PROPERTY ROOM USE ONLY
PROP AFFILIATION S			ID / SERIAL NUMBER TORN		VALUE	
ADDITIONAL INFORMATION PM 16						

CODES E C	ITEM # 14	QTY 1	ITEM NAME HOODED SWEAT JACKET	MAKE	MODEL / CALIBER BLACK	PROPERTY ROOM USE ONLY
PROP AFFILIATION S			ID / SERIAL NUMBER		VALUE	
ADDITIONAL INFORMATION PM 16						

39 DATE AND TIME OF REPORT 11-15-06 2100				40 REPORTING OFFICER / ID NO. / DIV / UNIT [Redacted] 3322 / Spec. Serv. / Crime Scene Inv. Unit <i>[Signature]</i>			
41 FTO OFFICER / ID NO. / DIV / UNIT				42 APPROVED BY / ID NO. / UNIT <i>[Signature]</i>			

PROPERTY / EVIDENCE REPORT (continued)

VENTURA COUNTY SHERIFF'S DEPARTMENT
AGENCY IDENTIFIER CA0560000

4 RB NUMBER
06 - 30492

PROPERTY CLASSIFICATION CODES

SP - STOLEN PROPERTY
SR - STOLEN / RECOVERED
E - EVIDENCE
SK - SAFETYKEEPING
LP - LOST PROPERTY
RC - RECOVERED PROPERTY
FP - FOUND PROPERTY
T - TRANSACTION

PROPERTY CODES

A - CURRENCY / NOTES
B - JEWELRY / PRECIOUS METALS
C - CLOTHING / FURS
D - VEHICLES
E - OFFICE EQUIPMENT
F - ELECTRONIC EQUIPMENT
G - FIREARMS
H - HOUSEHOLD GOODS
I - CONSUMABLE GOODS
J - LIVESTOCK
K - MISCELLANEOUS
L - BIKE

CODES E C	ITEM # 15	QTY 3	ITEM NAME CLOTHING	MAKE	MODEL / CALIBER	PROPERTY ROOM USE ONLY
PROP AFFILIATION S			ID / SERIAL NUMBER 1 WHT T-SHIRT, 1 GRAY T-SHIRT, 1 WHT TANK TOP		VALUE	
ADDITIONAL INFORMATION PM 16						

CODES E C	ITEM # 16	QTY 2	ITEM NAME SHOES	MAKE	MODEL / CALIBER WHITE	PROPERTY ROOM USE ONLY
PROP AFFILIATION S			ID / SERIAL NUMBER W/ 2 SOCKS		VALUE	
ADDITIONAL INFORMATION PM 16						

CODES E K	ITEM # 17	QTY 1	ITEM NAME MAGAZINE	MAKE HI-POINT	MODEL / CALIBER	PROPERTY ROOM USE ONLY
PROP AFFILIATION S			ID / SERIAL NUMBER WITH 7 .45cal ROUNDS		VALUE	
ADDITIONAL INFORMATION REMOVED FROM ITEM 5						

CODES E K	ITEM # 17	QTY 1	ITEM NAME ROUND	MAKE	MODEL / CALIBER .45cal	PROPERTY ROOM USE ONLY
PROP AFFILIATION S			ID / SERIAL NUMBER		VALUE	
ADDITIONAL INFORMATION REMOVED FROM CHAMBER OF ITEM 5						

CODES	ITEM #	QTY	ITEM NAME	MAKE	MODEL / CALIBER	PROPERTY ROOM USE ONLY
PROP AFFILIATION			ID / SERIAL NUMBER		VALUE	
ADDITIONAL INFORMATION						

CODES	ITEM #	QTY	ITEM NAME	MAKE	MODEL / CALIBER	PROPERTY ROOM USE ONLY
PROP AFFILIATION			ID / SERIAL NUMBER		VALUE	
ADDITIONAL INFORMATION						

CODES	ITEM #	QTY	ITEM NAME	MAKE	MODEL / CALIBER	PROPERTY ROOM USE ONLY
PROP AFFILIATION			ID / SERIAL NUMBER		VALUE	
ADDITIONAL INFORMATION						

39 DATE AND TIME OF REPORT 11-15-06 2100	40 REPORTING OFFICER / ID NO. / DIV / UNIT ██████████ 3322 / Spec. Serv. / Crime Scene Inv. Unit <i>SB</i>
41 FTO OFFICER / ID NO. / DIV / UNIT	42 APPROVED BY / ID NO. / UNIT <i>SGT. OBLEWON</i>

2 RD	3 BEAT	4 RB NUMBER
9072	9G01	06 - 30492

Arrived at the scene at 1930 hours.

Took overall available light photos of the southeast parking area. Took photos of the southeast parking area showing multiple vehicles parked in parking spaces, patrol vehicle #3263 parked by parking area entrance (behind suspect vehicle), Detective Matthews' vehicle (red minivan) parked in parking space against the east wall, and the suspect vehicle (white Ford F-150, license [REDACTED]) parked at the north end, facing north. Took photos of Detective Matthews' notebook (Photo Marker 10) located on the grass by the middle tree, just west of the southeast parking area. Took photos of the southeast parking area showing empty casings on ground and planter by entrance (PM's 1-4, 8), bullet fragment on ground under patrol vehicle (PM 7), bullet fragments on ground south of patrol vehicle (PM's 5-6), and rapid tire acceleration marks on ground in the third parking space (from northwest corner of parking area; PM 9). Took photos of the area around the F-150 showing miscellaneous medical supplies used by EMT personnel, two red Sheriff's department medical bags, cloth gloves with glass pipe (PM 14), cellular phone and lighter (PM 13), boxer style underwear and loose coins (PM 15), various clothing items and torn parking sticker (PM 16), bullet (PM 11), and pants, wallet, and handgun (PM 12). Took exterior photos of the F-150 showing bullet in front plastic grille, bullet lodged in front bumper, three bullet holes on the driver's side of the front windshield, and two bullet holes in the tail gate. Took interior photos of the F-150 showing bullet damage to driver's side dashboard, and transmission position indicator on dash indicating position "2".

Collected items at all Photo Markers (except 9).

For the purposes of booking, the F-150 and its keys are listed on this property report (vehicle was transported to the property warehouse).

39 DATE AND TIME OF REPORT 11-15-08 2100	40 REPORTING OFFICER / ID NO. / DIV / UNIT [REDACTED] 3322 / Spec. Serv. / Crime Scene Inv. Unit. <i>[Signature]</i>
41 FTO OFFICER / ID NO. / DIV / UNIT	[REDACTED] ID NO. / UNIT <i>[Signature]</i>

9G
9072

REPORTING DEPARTMENT PCSO		LOCATION CODE 5600	DATE / TIME OF REPORT 11-15-06 0100	NOTICE OF STORED VEHICLE DELIVERED PERSONALLY <input type="checkbox"/>	FILE NO. 06-30492
[REDACTED]		ODOMETER READING UNK	VIN CLEAR IN SVS? <input type="checkbox"/> YES <input checked="" type="checkbox"/> NO	DATE / TIME DISPATCH NOTIFIED 11-15-06-0100	
YEAR 1999	MAKE FORD	MODEL F150	BODY TYPE PU	COLOR WAT	MONTH / YEAR 12/06
[REDACTED]		ENGINE NO. —	VALUATION BY <input checked="" type="checkbox"/> OFFICER <input type="checkbox"/> OWNER		
REGISTERED OWNER ADRIAN D. CANLEY			LEGAL OWNER		

STORED IMPOUNDED RELEASED RECOVERED - VEHICLE / COMPONENT

TOWING / STORAGE CONCERN (NAME, ADDRESS, PHONE) **McLoys 104 N PALM DR, SANTA PAULA, CA 525-5558**

TOWED TO / STORED AT **104 N PALM DR, SANTA PAULA, CA 525-5558**

STORAGE AUTHORITY / REASON **STORAGE 22655.5 VC - FV100N16**

AIRBAG? YES NO DRIVEABLE? YES NO JUNK UNK VIN SWITCHED? YES NO

CONDITION	YES	NO	ITEMS	YES	NO	ITEMS	YES	NO	ITEMS	YES	NO	TIRES / WHEELS	CONDITION
WRECKED		<input checked="" type="checkbox"/>	SEAT (FRONT)	<input checked="" type="checkbox"/>		REGISTRATION		<input checked="" type="checkbox"/>	CAMPER		<input checked="" type="checkbox"/>	LEFT FRONT	
BURNED HULK per 431(i) VC			SEAT (REAR)	<input checked="" type="checkbox"/>		ALT / GENERATOR	<input checked="" type="checkbox"/>		VESSEL AS LOAD			RIGHT FRONT	
VANDALIZED			RADIO	<input checked="" type="checkbox"/>		BATTERY	<input checked="" type="checkbox"/>		FIREARMS			LEFT REAR	
ENG. / TRANS. STRIP			TAPE DECK		<input checked="" type="checkbox"/>	DIFFERENTIAL	<input checked="" type="checkbox"/>		OTHER			RIGHT REAR	
MISC. PARTS STRIP			TAPES		<input checked="" type="checkbox"/>	TRANSMISSION	<input checked="" type="checkbox"/>					SPARE	yes
BODY METAL STRIP			OTHER RADIO	CD		AUTOMATIC	<input checked="" type="checkbox"/>					HUB CAPS	
SURGICAL STRIP per 431(b) VC		<input checked="" type="checkbox"/>	IGNITION KEY	<input checked="" type="checkbox"/>		MANUAL		<input checked="" type="checkbox"/>				SPECIAL WHEELS	

RELEASE VEHICLE TO: R/O OR AGENT AGENCY HOLD 22850.3 VC

NAME OF PERSON / AGENCY AUTHORIZING RELEASE: _____ I.D. NO. _____ DATE _____

SIGNATURE OF PERSON AUTHORIZING RELEASE: _____

GARAGE PRINCIPAL / AGENT STORING VEHICLE (SIGNATURE) **[Signature]** DATE / TIME **11-15-06 1:45pm**

CERTIFICATION: I, THE UNDERSIGNED, DO HEREBY CERTIFY THAT I AM LEGALLY AUTHORIZED AND ENTITLED TO TAKE POSSESSION OF THE ABOVE DESCRIBED VEHICLE.

SIGNATURE OF PERSON TAKING POSSESSION: _____

STOLEN VEHICLE / COMPONENT EMBEZZLED VEHICLE PLATE(S) REPORT

DATE / TIME OF OCCURRENCE	DATE / TIME REPORTED	NAME OF REPORTING PARTY (R/P)	DRIVER LICENSE NO. / STATE
LAST DRIVER OF VEHICLE	DATE / TIME	ADDRESS OF R/P	TELEPHONE OF R/P ()

I CERTIFY OR DECLARE UNDER PENALTY OF PERJURY UNDER THE LAWS OF THE STATE OF CALIFORNIA THAT THE FOREGOING IS TRUE AND CORRECT.

SIGNATURE OF PERSON MAKING REPORT _____

REMARKS
(LIST PROPERTY, TOOLS, VEHICLE DAMAGE, ARRESTS)

DRIVER'S NAME Adrian Canley	ARRESTED / SECTION? <input type="checkbox"/> YES <input checked="" type="checkbox"/> NO	REPORTED BY L. NATH	CARGO / TYPE? <input type="checkbox"/> YES <input checked="" type="checkbox"/> NO	VALUE \$ <input type="checkbox"/> BILL OF LADING ATTACHED
---------------------------------------	--	-------------------------------	--	--

Suitcase, misc clothes, Binoculars, Subwoofer enclosure, CD's, Jumper Cables, Extension Cord

SIGNATURE OF OFFICER TAKING REPORT [Signature]		I.D. NO. 3421	SUPERVISOR [Signature]	REQUIRED NOTICES SENT TO REGISTERED AND LEGAL OWNERS PER 22852 VC? <input type="checkbox"/> YES <input checked="" type="checkbox"/> NO
				DATE NOTIFIED

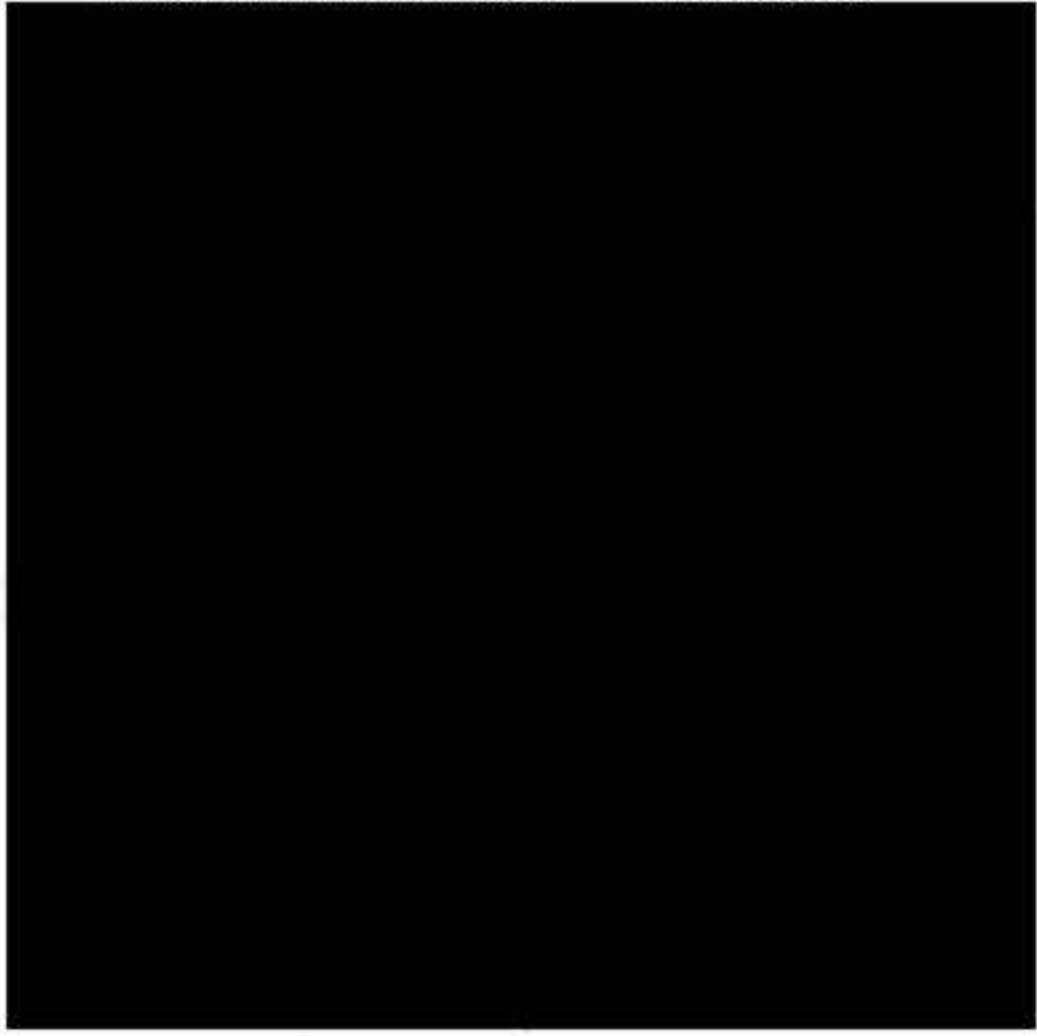



PROPERTY / EVIDENCE REPORT

1 CONNECTING REPORT NUMBERS		2 RD 9072	3 BEAT 9G01	4 RB NUMBER 06-30492		
5 INCIDENT / OFFENSE(S) (List all probable cause offenses pertaining to this RB) Officer Involved Shooting			6 <input type="checkbox"/> Misdemeanor <input type="checkbox"/> Felony		7 DATE OF INCIDENT 11-14-06	
8 STREET ADDRESS AND CITY [REDACTED] Thousand Oaks				9 STOLEN PROPERTY VALUE TOTAL -		
10 CODE S	11 NAME (Last, First Middle, Gen.) / FIRM NAME Canley, Adrian		AKA/Moniker	12 RACE -	13 SEX M	
16 RESIDENCE ADDRESS / (<input type="checkbox"/> Same as Box # _____)			CITY	STATE	ZIP	
15 BUSINESS PHONE - / -						
18 CODE V	19 NAME (Last, First Middle, Gen.) / FIRM NAME Matthews, Shane (ID #3127)		AKA/Moniker	20 RACE W	21 SEX M	
24 RESIDENCE ADDRESS / (<input type="checkbox"/> Same as Box # _____)			CITY	STATE	ZIP	
23 BUSINESS PHONE - / -						
26 CODE	27 NAME (Last, First Middle, Gen.) / FIRM NAME		AKA/Moniker	28 RACE	29 SEX	
32 RESIDENCE ADDRESS / (<input type="checkbox"/> Same as Box # _____)			CITY	STATE	ZIP	
31 BUSINESS PHONE /						
33 RESIDENCE PHONE /						
10 NARRATIVE						
<p>On 11-14-06, at about 2115 hrs., I arrived at Los Robles Hospital. I took overall photos of the body of suspect Canley, Adrian [REDACTED]. I took additional photos of injuries to Canley's left hand (thumb and index finger). I also photographed the tattoos on the front of Canley's torso and the back of his neck. I collected gun shot residue samples from Canley's hands. I photographed the body bag tag (#49262).</p> <p>At about 2240 hrs., I arrived at East Valley Station. I took overall photos of Sr. Dep. Shane Matthews (#3127). I took additional photos of Matthews' pistol [REDACTED] both loaded (its original state) and unloaded. There was one round in the chamber and seven in the magazine. I collected the pistol and ammunition.</p> <p>I downloaded 37 pictures total (23 hospital + 14 officer). I booked the items collected into property.</p>						
PROPERTY / EVIDENCE INFORMATION						
35 LOCATION BOOKED: <input checked="" type="checkbox"/> CRIME LAB <input type="checkbox"/>			36 SEARCH WARRANT? <input type="checkbox"/> Yes <input checked="" type="checkbox"/> No		37 FINDER WISHES TO CLAIM? <input type="checkbox"/> Yes <input type="checkbox"/> No	
38 PROPERTY CLASSIFICATION CODES						
SP - STOLEN PROPERTY SR - STOLEN / RECOVERED E - EVIDENCE SK - SAFEKEEPING		LP - LOST PROPERTY RC - RECOVERED PROPERTY FP - FOUND PROPERTY T - TRANSACTION		PROPERTY CODES A - CURRENCY / NOTES B - JEWELRY / PRECIOUS METALS C - CLOTHING / FURS D - VEHICLES E - OFFICE EQUIPMENT F - ELECTRONIC EQUIPMENT G - FIREARMS H - HOUSEHOLD GOODS I - CONSUMABLE GOODS J - LIVESTOCK K - MISCELLANEOUS L - BIKE NOTE: ALL VEHICLES SHOULD ALSO BE ENTERED ON A CHP106 REPORT		
CODES E	ITEM # G	QTY 1	ITEM NAME Pistol	MAKE Sig Arms	MODEL / CALIBER P-226 / .40cal. S&W	PROPERTY ROOM USE ONLY
PROP AFFILIATION V			ID / SERIAL NUMBER [REDACTED]	VALUE -		
ADDITIONAL INFORMATION Received from Matthews.						
CODES E	ITEM # K	QTY 2	ITEM NAME Ammunition	MAKE Speer	MODEL / CALIBER .40 cal. S&W	PROPERTY ROOM USE ONLY
PROP AFFILIATION V			ID / SERIAL NUMBER -	VALUE -		
ADDITIONAL INFORMATION One round. From chamber of Item #1 [pistol]						
39 DATE AND TIME OF REPORT 11-15-06 / 1820 hrs.			40 REPORTING OFFICER / ID NO. / DIV / UNIT [REDACTED] Spec. Serv. / CSIU			
41 FTO OFFICER / ID NO. / DIV / UNIT			42 APPROVED BY / ID NO. / UNIT [Signature]			

PROPERTY / EVIDENCE REPORT (continued)

4 RB NUMBER
06-30492

PROPERTY CLASSIFICATION CODES				PROPERTY CODES			
SP - STOLEN PROPERTY	LP - LOST PROPERTY	A - CURRENCY / NOTES	D - VEHICLES	G - FIREARMS	J - LIVESTOCK		
SR - STOLEN / RECOVERED	RC - RECOVERED PROPERTY	B - JEWELRY / PRECIOUS METALS	E - OFFICE EQUIPMENT	H - HOUSEHOLD GOODS	K - MISCELLANEOUS		
E - EVIDENCE	FP - FOUND PROPERTY	C - CLOTHING / FURS	F - ELECTRONIC EQUIPMENT	I - CONSUMABLE GOODS	L - BRZ		
BK - SAFEKEEPING	T - TRANSACTION						

CODES E K	ITEM # 3	QTY 7	ITEM NAME Ammunition	MAKE Speer	MODEL / CALIBER .40 cal. S&W	PROPERTY ROOM USE ONLY
PROP AFFILIATION V	ID / SERIAL NUMBER -				VALUE -	
ADDITIONAL INFORMATION Ammunition from magazine.						

CODES E K	ITEM # 4	QTY 1	ITEM NAME GSR Kit	MAKE -	MODEL / CALIBER -	PROPERTY ROOM USE ONLY
PROP AFFILIATION -	ID / SERIAL NUMBER -				VALUE -	
ADDITIONAL INFORMATION Gun Shot Residue Kit of suspect's hands. Collected at hospital.						

CODES	ITEM #	QTY	ITEM NAME	MAKE	MODEL / CALIBER	PROPERTY ROOM USE ONLY
PROP AFFILIATION	ID / SERIAL NUMBER				VALUE	
ADDITIONAL INFORMATION						

CODES	ITEM #	QTY	ITEM NAME	MAKE	MODEL / CALIBER	PROPERTY ROOM USE ONLY
PROP AFFILIATION	ID / SERIAL NUMBER				VALUE	
ADDITIONAL INFORMATION						

CODES	ITEM #	QTY	ITEM NAME	MAKE	MODEL / CALIBER	PROPERTY ROOM USE ONLY
PROP AFFILIATION	ID / SERIAL NUMBER				VALUE	
ADDITIONAL INFORMATION						

CODES	ITEM #	QTY	ITEM NAME	MAKE	MODEL / CALIBER	PROPERTY ROOM USE ONLY
PROP AFFILIATION	ID / SERIAL NUMBER				VALUE	
ADDITIONAL INFORMATION						

CODES	ITEM #	QTY	ITEM NAME	MAKE	MODEL / CALIBER	PROPERTY ROOM USE ONLY
PROP AFFILIATION	ID / SERIAL NUMBER				VALUE	
ADDITIONAL INFORMATION						

39 DATE AND TIME OF REPORT 11-15-06/1820 hrs.	40 REPORTING OFFICER / ID NO. / DIV / UNIT [Redacted] Spec. Serv. / CSIU
41 FTO OFFICER / ID NO. / DIV / UNIT	42 APPROVED BY / ID NO. / UNIT [Signature]

PROPERTY / EVIDENCE REPORT

1. CONNECTING REPORT NUMBERS 1654-06 M.E.		2. RD 9072	3. BEAT 9G01	4. RB NUMBER 06-30492
5. INCIDENT / OFFENSE(S) (List all probable cause offenses pertaining to this RB.) OFFICER INVOLVED SHOOTING		6. <input type="checkbox"/> Misdemeanor <input type="checkbox"/> Felony		7. DATE OF INCIDENT 11-14-06
8. LOCATION OF INCIDENT (STREET ADDRESS AND CITY) 2222 LOS FELIZ DRIVE, THOUSAND OAKS				9. STOLEN PROPERTY VALUE TOTAL -

10. CODE S	11. NAME (Last, First, Middle, Gen.) / FIRM NAME CANLEY, ADRIAN	AKA/Moniker	12. RACE H	13. SEX M	13. DOB [REDACTED]	15. BUSINESS PHONE - / -
16. RESIDENCE ADDRESS / (<input type="checkbox"/> Same as Box # _____)			CITY	STATE	17. RESIDENCE PHONE - / -	
18. CODE V	19. NAME (Last, First, Middle, Gen.) / FIRM NAME MATTHEWS, SHANE	AKA/Moniker	20. RACE W	21. SEX M	22. DOB -	23. BUSINESS PHONE - / -
24. RESIDENCE ADDRESS / (<input type="checkbox"/> Same as Box # _____)			CITY	STATE	ZIP	25. RESIDENCE PHONE - / -
26. CODE	27. NAME (Last, First, Middle, Gen.) / FIRM NAME	AKA/Moniker	28. RACE	29. SEX	30. DOB	31. BUSINESS PHONE /
32. RESIDENCE ADDRESS / (<input type="checkbox"/> Same as Box # _____)			CITY	STATE	ZIP	33. RESIDENCE PHONE /

NARRATIVE

NARRATIVE ON PAGE THREE.

35. LOCATION BOOKED: <input checked="" type="checkbox"/> CRIME LAB <input type="checkbox"/>	36. SEARCH WARRANT? <input type="checkbox"/> Yes <input type="checkbox"/> No	37. FINDER WISHES TO CLAIM? <input type="checkbox"/> Yes <input type="checkbox"/> No
---	--	--

38. PROPERTY CLASSIFICATION CODES		PROPERTY CODES			
SP - STOLEN PROPERTY	LP - LOST PROPERTY	A - CURRENCY / NOTES	D - VEHICLES	G - FIREARMS	J - LIVESTOCK
SR - STOLEN / RECOVERED	RC - RECOVERED PROPERTY	B - JEWELRY / PRECIOUS METALS	E - OFFICE EQUIPMENT	H - HOUSEHOLD GOODS	K - MISCELLANEOUS
S - EVIDENCE	FP - FOUND PROPERTY	C - CLOTHING / FURS	F - ELECTRONIC EQUIPMENT	I - CONSUMABLE GOODS	L - BIKE
SK - SAFEKEEPING	T - TRANSACTION	NOTE: ALL VEHICLES SHOULD ALSO BE ENTERED ON A CHP100 REPORT			

CODES E / K	ITEM # 1	QTY 1	ITEM NAME BULLET JACKET FRAGMENT	MAKE -	MODEL / CALIBER -	PROPERTY ROOM USE ONLY
PROP AFFILIATION			ID / SERIAL NUMBER	VALUE		
-			-	-		

ADDITIONAL INFORMATION
COLLECTED FROM SUSPECT'S SWEATER AT MEDICAL EXAMINER'S OFFICE

CODES E / K	ITEM # 2	QTY 2	ITEM NAME BULLET	MAKE -	MODEL / CALIBER -	PROPERTY ROOM USE ONLY
PROP AFFILIATION			ID / SERIAL NUMBER	VALUE		
-			-	-		

ADDITIONAL INFORMATION
COLLECTED FROM SUSPECT'S BACK AT MEDICAL EXAMINER'S OFFICE

39. DATE AND TIME OF REPORT 11-16-06 0700 HOURS	40. REPORTING OFFICER / ID NO. / DIV / UNIT [REDACTED] 3808 / SPEC. SERV. / CRIME SCENE INV. UNIT
41. FTO OFFICER / ID NO. / DIV / UNIT	42. APPROVED BY / ID NO. / UNIT SGT. OBREGON 1282

PROPERTY / EVIDENCE REPORT (continued)

VENTURA COUNTY SHERIFF'S DEPARTMENT
AGENCY IDENTIFIER CA0560000

4 RB NUMBER
06-30492

PROPERTY CLASSIFICATION CODES				PROPERTY CODES			
SP - STOLEN PROPERTY	SR - STOLEN / RECOVERED	E - EVIDENCE	BK - SAFES/PSWG	LP - LOST PROPERTY	RC - RECOVERED PROPERTY	FP - FOUND PROPERTY	T - TRANSACTION
A - CURRENCY / NOTES	B - JEWELRY / PRECIOUS METALS	C - CLOTHING / FURS	D - VEHICLES	E - OFFICE EQUIPMENT	F - ELECTRONIC EQUIPMENT	G - FIREARMS	H - HOUSEHOLD GOODS
I - LIVESTOCK	J - MISCELLANEOUS	K - MISCELLANEOUS	L - BIKE				

CODES E K	ITEM # 3	QTY 1	ITEM NAME FTA CARD	MAKE -	MODEL / CALIBER -	PROPERTY ROOM USE ONLY
PROP AFFILIATION			ID / SERIAL NUMBER		VALUE	
-			-		-	
ADDITIONAL INFORMATION RECEIVED FROM FORENSIC PATHOLOGY TECH. GAINER AT MEDICAL EXAMINER'S OFFICE						

CODES E K	ITEM # 4	QTY 1	ITEM NAME SHEET	MAKE -	MODEL / CALIBER -	PROPERTY ROOM USE ONLY
PROP AFFILIATION			ID / SERIAL NUMBER		VALUE	
-			-		-	
ADDITIONAL INFORMATION USED TO EXAMINE SUSPECTS CLOTHING AT MEDICAL EXAMINER'S OFFICE						

CODES	ITEM #	QTY	ITEM NAME	MAKE	MODEL / CALIBER	PROPERTY ROOM USE ONLY
PROP AFFILIATION			ID / SERIAL NUMBER		VALUE	
-			-		-	
ADDITIONAL INFORMATION						

CODES	ITEM #	QTY	ITEM NAME	MAKE	MODEL / CALIBER	PROPERTY ROOM USE ONLY
PROP AFFILIATION			ID / SERIAL NUMBER		VALUE	
-			-		-	
ADDITIONAL INFORMATION						

CODES	ITEM #	QTY	ITEM NAME	MAKE	MODEL / CALIBER	PROPERTY ROOM USE ONLY
PROP AFFILIATION			ID / SERIAL NUMBER		VALUE	
-			-		-	
ADDITIONAL INFORMATION						

CODES	ITEM #	QTY	ITEM NAME	MAKE	MODEL / CALIBER	PROPERTY ROOM USE ONLY
PROP AFFILIATION			ID / SERIAL NUMBER		VALUE	
-			-		-	
ADDITIONAL INFORMATION						

CODES	ITEM #	QTY	ITEM NAME	MAKE	MODEL / CALIBER	PROPERTY ROOM USE ONLY
PROP AFFILIATION			ID / SERIAL NUMBER		VALUE	
-			-		-	
ADDITIONAL INFORMATION						

39 DATE AND TIME OF REPORT 11-16-06 0700 HOURS		40 REPORTING OFFICER / ID NO. / DIV / UNIT [REDACTED] / 3808 / SPEC. SERV / CRIME SCENE INV. UNIT	
41 FTO OFFICER / ID NO. / DIV / UNIT		42 APPROVED BY / ID NO. / UNIT SGT. [Signature] / 1272	

2 RD 9072	3 BEAT 9G01	4 RB NUMBER 06-30492
--------------	----------------	-------------------------

On 11-15-06, at approximately 0815 hours, I arrived at the Medical Examiner's Office. I took photos showing the body bag tag (#49262).

I took overall photos of the suspect showing him lying on the gurney. I took photos of the suspect's injuries including a gunshot wound on the right side of the suspect's chest, a small abrasion on the suspect's forehead, and small lacerations on his thumb and index finger. I took photos showing the upper portion of the suspect's back where a bullet was recovered. I photographed the inside of the suspect's chest cavity showing a gunshot wound.

I photographed the suspect's clothing including his shoes, socks, belt, pants, tank top, t-shirt, long sleeved shirt, and sweater. I took photos showing a bullet hole in the tank top, t-shirt, long sleeved shirt, and sweater. I photographed a piece of bullet jacket fragment on the suspect's sweater.

I collected the recovered bullet from the suspect's back, bullet jacket fragment from the suspect's sweater, FTA card, and the sheet used to examine the suspect's clothing.

I downloaded 42 images.

39 DATE AND TIME OF REPORT 11-16-06 0700 HOURS	40 REPORTING OFFICER / ID NO. / DIV / UNIT [REDACTED] / 3808 / SPEC. SERV. / CRIME SCENE INV. UNIT
41 FTO OFFICER / ID NO. / DIV / UNIT	42 APPROVED BY / ID NO. / UNIT Sgt. O'Brien

PROPERTY / EVIDENCE REPORT

VENTURA COUNTY SHERIFF'S DEPARTMENT

AGENCY IDENTIFIER CA0560000

Page 1 of 1

1 CONNECTING REPORT NUMBERS		2 RD 9072	3 BEAT 9G01	4 RB NUMBER 06-30492		
5 PROPERTY TYPE: <input checked="" type="checkbox"/> EVIDENCE <input type="checkbox"/> FOUND <input type="checkbox"/> SAFEKEEPING		6 <input type="checkbox"/> Misdemeanor <input checked="" type="checkbox"/> Felony		7 DATE OF INCIDENT 11-14-06		
8 INCIDENT / OFFENSE(S) (List all probable cause offenses pertaining to this RB.) Officer Involved Shooting		9 LOCATION OF INCIDENT (STREET ADDRESS AND CITY) [REDACTED], Thousand Oaks, CA				
CODE: V - Victim S - Suspect A - Arrestee F - Finder O - Owner R - Reporting Party (Use Same Codes in Property Affiliation Boxes.)						
11 NAME (Last, First, Middle, Gen.) / FIRM NAME V-1 Matthews, Shane	AKA / Moniker	RACE W	SEX M	14 DOB		
15 BUSINESS PHONE (805) 494-8200		16 RESIDENCE ADDRESS / (<input type="checkbox"/> Same as Box # _____) CITY STATE ZIP				
Ventura County Sheriff's Department		(N/A)				
19 NAME (Last, First, Middle, Gen.) / FIRM NAME S-1 Canley, Adrian	AKA / Moniker	RACE W	SEX M	22 DOB		
23 BUSINESS PHONE (N/A)		24 RESIDENCE ADDRESS / (<input type="checkbox"/> Same as Box # _____) CITY STATE ZIP				
Deceased		(N/A)				
27 NAME (Last, First, Middle, Gen.) / FIRM NAME	AKA / Moniker	RACE	SEX	30 DOB		
28 BUSINESS PHONE ()		32 RESIDENCE ADDRESS / (<input type="checkbox"/> Same as Box # _____) CITY STATE ZIP				
		()				
34 NARRATIVE						
Detective Matthews gave Deputy Paul Feruzza his digital recorder on 11-14-06, just after the shooting. Deputy Feruzza Matthew's digital recorder to Detective Jon Smith a few minutes after Matthews gave it to him. Detective Smith gave me Matthews' digital recorder on 11-14-06 at about 1900 hours. On 11-15-06, I transferred the sound files to a compact disk.						
35 PROPERTY / EVIDENCE INFORMATION						
LOCATION BOOKED: <input checked="" type="checkbox"/> Ventura E.C. _____		SEARCH WARRANT? Yes <input type="checkbox"/> No <input checked="" type="checkbox"/>		FINDER WISHES TO CLAIM? <input type="checkbox"/> Yes <input checked="" type="checkbox"/> No		
36 PROPERTY CLASSIFICATION CODES E - EVIDENCE BK - SAFEKEEPING RC - RECOVERED PROPERTY FP - FOUND PROPERTY		PROPERTY CODES A - CURRENCY/NOTES B - JEWELRY/PRECIOUS METALS C - CLOTHING/FURS D - VEHICLE E - OFFICE EQUIPMENT F - ELECTRONIC EQUIPMENT G - FIREARMS H - HOUSEHOLD GOODS I - CONSUMABLE GOODS J - LIVESTOCK K - MISCELLANEOUS				
CODE	ITEM #	QTY	ITEM NAME	MAKE	MODEL / CALIBER	ID / SERIAL NUMBER
EK	1	1	Smartcard from Detective Matthews' digital recorder containing his original recording of the shooting.			
PROP. AFFIL. ADDITIONAL INFORMATION						
CODE	ITEM #	QTY	ITEM NAME	MAKE	MODEL / CALIBER	ID / SERIAL NUMBER
EL	2	1	Compact disk, containing two files, the original transferred WAV file of Detetive's Matthews' digital recorder file of the shooting.			
PROP. AFFIL. ADDITIONAL INFORMATION						
CODE	ITEM #	QTY	ITEM NAME	MAKE	MODEL / CALIBER	ID / SERIAL NUMBER
PROP. AFFIL. ADDITIONAL INFORMATION						
37 DATE AND TIME OF REPORT 11/15/06/ 4:59 PM		38 REPORTING OFFICER / ID NO. / DIV / UNIT Sgt. M. Powers/#1365/Special Services			39 APPROVED BY / ID NO. <i>[Signature]</i> 2238	
40 COPIES TO <input type="checkbox"/> DET / MC <input type="checkbox"/> NARC <input type="checkbox"/> GANG / SEU <input type="checkbox"/> STATS <input type="checkbox"/> PRESS <input type="checkbox"/> DOJ <input type="checkbox"/> COURT <input type="checkbox"/> OTHER						

PROPERTY / EVIDENCE REPORT

VENTURA COUNTY SHERIFF'S DEPARTMENT

AGENCY IDENTIFIER CA0560000

Page 1 of 1

1 CONNECTING REPORT NUMBERS	2 REPORT # 9072	3 PLAT 9G	4 FILE NUMBER 06-30492
-----------------------------	-----------------	-----------	------------------------

5 PROPERTY TYPE: <input checked="" type="checkbox"/> EVIDENCE <input type="checkbox"/> FOUND <input type="checkbox"/> SAFEKEEPING	6 <input checked="" type="checkbox"/> Misdemeanor <input type="checkbox"/> Felony	7 DATE OF INCIDENT 11/14/06
--	--	-----------------------------

8 INCIDENT / OFFENSE(S) (List all probable cause offenses pertaining to this PR.) Officer Involved Shooting	9 LOCATION OF INCIDENT - STREET ADDRESS AND CITY
--	--

CODE: V - Victim S - Suspect A - Arrestee F - Finder O - Owner R - Reporting Party (Use Same Codes in Property Affiliation Boxes.)

CODE 10	10 NAME (Last, First, Middle, Gen.) / FIRM NAME Sr. Dep. Matthews # 3127	12 RACE	13 SEX	14 DOB	15 BUSINESS PHONE ()
---------	---	---------	--------	--------	--------------------------

16 RESIDENCE ADDRESS / (<input type="checkbox"/> Same as Box # _____)	CITY	STATE	ZIP	17 RESIDENCE PHONE ()
---	------	-------	-----	---------------------------

CODE 18	18 NAME (Last, First, Middle, Gen.) / FIRM NAME	19 RACE	20 SEX	22 DOB	23 BUSINESS PHONE ()
---------	---	---------	--------	--------	--------------------------

24 RESIDENCE ADDRESS / (<input type="checkbox"/> Same as Box # _____)	CITY	STATE	ZIP	25 RESIDENCE PHONE ()
---	------	-------	-----	---------------------------

CODE 26	26 NAME (Last, First, Middle, Gen.) / FIRM NAME	27 RACE	28 SEX	30 DOB	31 BUSINESS PHONE ()
---------	---	---------	--------	--------	--------------------------

32 RESIDENCE ADDRESS / (<input type="checkbox"/> Same as Box # _____)	CITY	STATE	ZIP	33 RESIDENCE PHONE ()
---	------	-------	-----	---------------------------

34 NARRATIVE
Booked as Evidence

35 PROPERTY / EVIDENCE INFORMATION	X	N/A
LOCATION BOOKED: <input checked="" type="checkbox"/> Ventura <input type="checkbox"/> E.C.	SEARCH WARRANT? <input type="checkbox"/> Yes <input checked="" type="checkbox"/> No	FINDER WISHES TO CLAIM? <input type="checkbox"/> Yes <input type="checkbox"/> No

36 PROPERTY CLASSIFICATION CODES E - EVIDENCE SK - SAFEKEEPING	RC - RECOVERED PROPERTY FP - FOUND PROPERTY	PROPERTY CODES A - CURRENCY/NOTES B - JEWELRY/PRECIOUS METALS C - CLOTHING/FURS D - VEHICLE E - OFFICE EQUIPMENT F - ELECTRONIC EQUIPMENT G - FIREARMS H - HOUSEHOLD GOODS I - CONSUMABLE GOODS J - LIVESTOCK K - MISCELLANEOUS
--	--	--

CODE EK	ITEM # 1	QTY 1	ITEM NAME CD	MAKE	MODEL / CALIBER	ID / SERIAL NUMBER
---------	----------	-------	--------------	------	-----------------	--------------------

PROP. AFFIL.	ADDITIONAL INFORMATION All interviews done by Det. Jon R Smith # 2569
--------------	--

CODE	ITEM #	QTY	ITEM NAME	MAKE	MODEL / CALIBER	ID / SERIAL NUMBER
------	--------	-----	-----------	------	-----------------	--------------------

PROP. AFFIL.	ADDITIONAL INFORMATION
--------------	------------------------

CODE	ITEM #	QTY	ITEM NAME	MAKE	MODEL / CALIBER	ID / SERIAL NUMBER
------	--------	-----	-----------	------	-----------------	--------------------

PROP. AFFIL.	ADDITIONAL INFORMATION
--------------	------------------------

37 DATE/TIME OF REPORT 11/30/06 8:42 AM	38 REPORTED BY / ID NO. Det. Smith # 2569 / East County M.C.	39 APPROVED BY / ID NO. <i>J. Smith</i> / ()
---	--	---

40 COPIES TO <input type="checkbox"/> DET / MC <input type="checkbox"/> NARC <input type="checkbox"/> GANG / SEU <input type="checkbox"/> STATS <input type="checkbox"/> PRESS <input type="checkbox"/> DOJ <input checked="" type="checkbox"/> COURT <input type="checkbox"/> OTHER
--

PROPERTY / EVIDENCE REPORT

VENTURA COUNTY SHERIFF'S DEPARTMENT

AGENCY IDENTIFIER CA0560000

1 CONNECTING REPORT NUMBERS		2 RD 9072	3 BEAT 9G01	4 RB NUMBER 060030492
-----------------------------	--	--------------	----------------	--------------------------

5 INCIDENT / OFFENSE(S) (List all probable cause offenses pertaining to this RB.) Officer involved Shooting /	6 <input type="checkbox"/> Misdemeanor <input type="checkbox"/> Felony	7 DATE OF INCIDENT 11/14/2006 1815
---	---	---------------------------------------

8 LOCATION OF INCIDENT (STREET ADDRESS AND CITY) Los Felis & Conejo School Road	9 STOLEN PROPERTY VALUE TOTAL
---	-------------------------------

CODE	V - Victim	S - Suspect	A - Arrestee	F - Finder	O - Owner	R - Reporting Party		
10	11 NAME (Last, First, Middle, Gen) / FIRM NAME S Canley, Adrian			AKA / Moniker	RACE 12	SEX 13	14 DOB [REDACTED]	15 BUSINESS PHONE
	15 RESIDENCE ADDRESS / (Same as Box # _____)		CITY	STATE	ZIP	17 RESIDENCE PHONE		
18	19 NAME (Last, First, Middle, Gen) / FIRM NAME			AKA / Moniker	RACE 20	SEX 21	22 DOB	23 BUSINESS PHONE
	24 RESIDENCE ADDRESS / (Same as Box # _____)		CITY	STATE	ZIP	25 RESIDENCE PHONE		
26	27 NAME (Last, First, Middle, Gen) / FIRM NAME			AKA / Moniker	RACE 28	SEX 29	30 DOB	31 BUSINESS PHONE
	32 RESIDENCE ADDRESS / (Same as Box # _____)		CITY	STATE	ZIP	33 RESIDENCE PHONE		

34 NARRATIVE
Cassette tape of interviews conducted.

PROPERTY/EVIDENCE INFORMATION
For Bicycles, include the type (boys, girls, road, BMX, etc), frame size (inches), wheel size (inches), number of gears and license no/city in the Additional Information field.

35 LOCATION BOOKED: Thousand Oaks	36 SEARCH WARRANT? <input type="checkbox"/> Yes <input checked="" type="checkbox"/> No	37 FINDER WISHES TO CLAIM? <input type="checkbox"/> Yes <input checked="" type="checkbox"/> No
--	--	--

38 PROPERTY CLASSIFICATION CODES SP - STOLEN PROPERTY LP - LOST PROPERTY SR - STOLEN/RECOVERED RC - RECOVERED PROPERTY E - EVIDENCE FP - FOUND PROPERTY SK - SAFEKEEPING T - TRANSACTION	PROPERTY CODES A - CURRENCY/NOTES D - VEHICLES G - FIREARMS J - LIVESTOCK B - JEWELRY/PRECIOUS METALS E - OFFICE EQUIPMENT H - HOUSEHOLD GOODS K - MISCELLANEOUS C - CLOTHING/FURS F - ELECTRONIC EQUIPMENT I - CONSUMABLE GOODS L - BIKE NOTE: ALL VEHICLES SHOULD ALSO BE ENTERED ON A CHP189 REPORT
---	--

CODES E K	ITEM # 1	QTY 1	ITEM NAME Cassette Tape	MAKE Sony	MODEL / CALIBER MC-60	PROPERTY ROOM USE ONLY
PROP AFFILIATIONS 1		ID / SERIAL NUMBER /		VALUE 0.00		
ADDITIONAL INFORMATION containing interviews conducted by Deputy Blanck						

CODES E K	ITEM # 2	QTY 1	ITEM NAME Cassette Tape	MAKE	MODEL / CALIBER	PROPERTY ROOM USE ONLY
PROP AFFILIATIONS 1		ID / SERIAL NUMBER /		VALUE 0.00		
ADDITIONAL INFORMATION containing interviews conducted by Deputy Kadosono						

39 DATE AND TIME OF REPORT 11/15/2006 0335	40 REPORTING OFFICER / ID NO. / DIV / UNIT DE - Deputy Blanck, Daniel - 3755 - ECPS-THOUSAND OAKS - ECPS THOUSAND OAKS-PATROL
---	--

41 FTO OFFICER / ID NO. / DIV / UNIT	42 APPROVED BY/ ID NO. / UNIT <i>[Signature]</i> / MTR6 / ECPS / INV
--------------------------------------	---

COPIES TO DET / MC NARC GANG / SEU STATS PRESS DOJ COURT OTHER

PROPERTY / EVIDENCE REPORT

VENTURA COUNTY SHERIFF'S DEPARTMENT

AGENCY IDENTIFIER CA0560000

1. CONNECTING REPORT NUMBERS			2. RD 9072	3. BEAT 96	4. RB NUMBER 06-30492
5. PROPERTY TYPE: <input checked="" type="checkbox"/> EVIDENCE <input type="checkbox"/> FOUND <input type="checkbox"/> SAFEKEEPING			6. <input type="checkbox"/> Misdemeanor <input checked="" type="checkbox"/> Felony		7. DATE OF INCIDENT 11-14-06/1830 HRS.
8. INCIDENT / OFFENSE(S) (List all probable cause offenses pertaining to this RB.) OFFICER INVOLVED SHOOTING			9. LOCATION OF INCIDENT (STREET ADDRESS AND CITY) [REDACTED]		
CODE: V - Victim S - Suspect A - Arrestee F - Finder O - Owner R - Reporting Party (Use Same Codes in Property Affiliation Boxes)					
10. CODE S	11. NAME (Last, First, Middle, Gen.) / FIRM NAME CANLEY, ADRIAN		12. AKA / Moniker		13. BUSINESS PHONE ()
[REDACTED]					
18. [REDACTED]					
24. RESIDENCE ADDRESS (<input type="checkbox"/> Same as Box # _____)			CITY	STATE	ZIP
25. RESIDENCE PHONE ()					
26. CODE S	27. NAME (Last, First, Middle, Gen.) / FIRM NAME CANLEY, ADRIAN		28. RACE	29. SEX	30. DOB
31. BUSINESS PHONE ()					
32. RESIDENCE ADDRESS (<input type="checkbox"/> Same as Box # _____)			CITY	STATE	ZIP
33. RESIDENCE PHONE ()					
34. NARRATIVE THE BELOW LISTED ITEM WAS BOOKED AS EVIDENCE INTO THE EAST COUNTY PROPERTY ROOM.					
35. PROPERTY / EVIDENCE INFORMATION					
LOCATION BOOKED: Ventura <input checked="" type="checkbox"/> E.C.			SEARCH WARRANT? Yes <input checked="" type="checkbox"/> No		FINDER WISHES TO CLAIM? Yes <input type="checkbox"/> No <input checked="" type="checkbox"/>
36. PROPERTY CLASSIFICATION CODES E - EVIDENCE RC - RECOVERED PROPERTY SK - SAFEKEEPING FP - FOUND PROPERTY			PROPERTY CODES A - CURRENCY/NOTES D - VEHICLE G - FIREARMS J - LIVESTOCK B - JEWELRY/PRECIOUS METALS E - OFFICE EQUIPMENT H - HOUSEHOLD GOODS K - MISCELLANEOUS C - CLOTHING/FURS F - ELECTRONIC EQUIPMENT I - CONSUMABLE GOODS		
CODE E/F	ITEM # 1	QTY 1	ITEM NAME CASSETTE TAPE	MAKE	MODEL / CALIBER
ID / SERIAL NUMBER					
PROP AFFIL: ✓ ADDITIONAL INFORMATION: WITNESS INTERVIEWS -					
CODE	ITEM #	QTY	ITEM NAME	MAKE	MODEL / CALIBER
ID / SERIAL NUMBER					
PROP AFFIL: ADDITIONAL INFORMATION					
CODE	ITEM #	QTY	ITEM NAME	MAKE	MODEL / CALIBER
ID / SERIAL NUMBER					
PROP AFFIL: ADDITIONAL INFORMATION					
37. DATE AND TIME OF REPORT 11-16-06/1520 HRS.		38. REPORTING OFFICER / ID NO. / DIV / UNIT Det. R. Brewer #2172 / EC Inv.			39. APPROVED BY / ID NO. John [Signature] SR. DEP.
40. COPIES TO: <input type="checkbox"/> DET / MC <input type="checkbox"/> NARC <input checked="" type="checkbox"/> GANG / SEU <input checked="" type="checkbox"/> STAS <input type="checkbox"/> PRESS <input type="checkbox"/> DOJ <input type="checkbox"/> COURT <input type="checkbox"/> OTHER					

**PROPERTY / EVIDENCE
REPORT**

VENTURA COUNTY SHERIFF'S DEPARTMENT

AGENCY IDENTIFIER CA0560000

Page 2 of _____

41. FBI NUMBER

PROPERTY CLASSIFICATION CODES				PROPERTY CODES			
E - EVIDENCE		RC - RECOVERED PROPERTY		A - CURRENCY/NOTES	D - VEHICLE	G - FIREARMS	J - LIVESTOCK
SK - SAFEKEEPING		FP - FOUND PROPERTY		B - JEWELRY/PRECIOUS METALS	E - OFFICE EQUIPMENT	H - HOUSEHOLD GOODS	K - MISCELLANEOUS
				C - CLOTHING/FURS	F - ELECTRONIC EQUIPMENT	I - CONSUMABLE GOODS	
CODE	ITEM #	QTY	ITEM NAME	MAKE	MODEL / CALIBER	ID / SERIAL NUMBER	
PROP AFFL	ADDITIONAL INFORMATION						
CODE	ITEM #	QTY	ITEM NAME	MAKE	MODEL / CALIBER	ID / SERIAL NUMBER	
PROP AFFL	ADDITIONAL INFORMATION						
CODE	ITEM #	QTY	ITEM NAME	MAKE	MODEL / CALIBER	ID / SERIALNUMBER	
PROP AFFL	ADDITIONAL INFORMATION						
CODE	ITEM #	QTY	ITEM NAME	MAKE	MODEL / CALIBER	ID / SERIAL NUMBER	
PROP AFFL	ADDITIONAL INFORMATION						
CODE	ITEM #	QTY	ITEM NAME	MAKE	MODEL / CALIBER	ID / SERIALNUMBER	
PROP AFFL	ADDITIONAL INFORMATION						
CODE	ITEM #	QTY	ITEM NAME	MAKE	MODEL / CALIBER	ID / SERIAL NUMBER	
PROP AFFL	ADDITIONAL INFORMATION						
CODE	ITEM #	QTY	ITEM NAME	MAKE	MODEL / CALIBER	ID / SERIALNUMBER	
PROP AFFL	ADDITIONAL INFORMATION						
CODE	ITEM #	QTY	ITEM NAME	MAKE	MODEL / CALIBER	ID / SERIAL NUMBER	
PROP AFFL	ADDITIONAL INFORMATION						
CODE	ITEM #	QTY	ITEM NAME	MAKE	MODEL / CALIBER	ID / SERIALNUMBER	
PROP AFFL	ADDITIONAL INFORMATION						
CODE	ITEM #	QTY	ITEM NAME	MAKE	MODEL / CALIBER	ID / SERIAL NUMBER	
PROP AFFL	ADDITIONAL INFORMATION						

PROPERTY / EVIDENCE REPORT

VENTURA COUNTY SHERIFF'S DEPARTMENT

AGENCY IDENTIFIER CA0560000

Page 1 of 1

1 CONNECTING REPORT NUMBERS		2 RD 9072	3 BEAT 9601	4 RB NUMBER 2006-30492		
5 PROPERTY TYPE: <input checked="" type="checkbox"/> EVIDENCE <input type="checkbox"/> FOUND <input type="checkbox"/> SAFEKEEPING		6 <input type="checkbox"/> Misdemeanor <input type="checkbox"/> Felony		7 DATE OF INCIDENT 11-14-06		
8 INCIDENT / OFFENSE(S) (List all probable cause offenses pertaining to this RB.) OFFICER INVOLVED SHOOTING		9 LOCATION OF INCIDENT (STREET ADDRESS AND CITY)				
CODE: V - Victim S - Suspect A - Arrestee F - Finder O - Owner R - Reporting Party (Use Same Codes in Property Affiliation Boxes.)						
10 CODE	11 NAME (Last, First, Middle, Gen.) / FIRM NAME P MATTHEWS, SHANE (DEPUTY SHERIFF)	12 RACE	13 SEX	14 DOB		
16 RESIDENCE ADDRESS / (<input type="checkbox"/> Same as Box # _____)		CITY	STATE	ZIP		
15 BUSINESS PHONE		()				
18 CODE	19 NAME (Last, First, Middle, Gen.) / FIRM NAME P CANLEY, ADRIAN DOYLE (DECEASED)	20 RACE	21 SEX	22 DOB		
24 RESIDENCE ADDRESS / (<input type="checkbox"/> Same as Box # _____)		CITY	STATE	ZIP		
23 BUSINESS PHONE		()				
26 CODE	27 NAME (Last, First, Middle, Gen.) / FIRM NAME	28 RACE	29 SEX	30 DOB		
32 RESIDENCE ADDRESS / (<input type="checkbox"/> Same as Box # _____)		CITY	STATE	ZIP		
31 BUSINESS PHONE		()				
33 RESIDENCE PHONE		()				
34 NARRATIVE THE FOLLOWING ITEM WAS BOOKED AS EVIDENCE:						
35 PROPERTY / EVIDENCE INFORMATION						
LOCATION BOOKED: <input checked="" type="checkbox"/> Ventura <input type="checkbox"/> E.C. <input type="checkbox"/> _____		SEARCH WARRANT ? <input type="checkbox"/> Yes <input checked="" type="checkbox"/> No		FINDER WISHES TO CLAIM? <input type="checkbox"/> Yes <input checked="" type="checkbox"/> No		
36 PROPERTY CLASSIFICATION CODES E - EVIDENCE RC - RECOVERED PROPERTY SK - SAFEKEEPING FP - FOUND PROPERTY		PROPERTY CODES A - CURRENCY/NOTES D - VEHICLE G - FIREARMS J - LIVESTOCK B - JEWELRY/PRECIOUS METALS E - OFFICE EQUIPMENT H - HOUSEHOLD GOODS K - MISCELLANEOUS C - CLOTHING/FURS F - ELECTRONIC EQUIPMENT I - CONSUMABLE GOODS				
CODE	ITEM #	QTY	ITEM NAME	MAKE	MODEL / CALIBER	ID / SERIAL NUMBER
E/K	1	1	CD ROM (INTERVIEWS)			
PROF. AFFIL. ADDITIONAL INFORMATION						
CODE	ITEM #	QTY	ITEM NAME	MAKE	MODEL / CALIBER	ID / SERIAL NUMBER
PROF. AFFIL. ADDITIONAL INFORMATION						
37 DATE AND TIME OF REPORT 11-15-06 11930		38 REPORTING OFFICER / ID NO. / DIV / UNIT DET. S. PETERSON / 2238 / MAJOR CRIMES			39 APPROVED BY / ID NO. SGT. W. J. [Signature] 3318	
40 COPIES TO <input type="checkbox"/> DET / MC <input type="checkbox"/> NARC <input type="checkbox"/> GANG / SEU <input type="checkbox"/> STATS <input type="checkbox"/> PRESS <input type="checkbox"/> DOJ <input type="checkbox"/> COURT <input type="checkbox"/> OTHER						

PROPERTY / EVIDENCE REPORT

VENTURA COUNTY SHERIFF'S DEPARTMENT

AGENCY IDENTIFIER CA0560000

Page 2 of _____

41 RB NUMBER

PROPERTY CLASSIFICATION CODES				PROPERTY CODES			
E - EVIDENCE		RC - RECOVERED PROPERTY		A - CURRENCY/NOTES	D - VEHICLE	G - FIREARMS	J - LIVESTOCK
SK - SAFEKEEPING		FP - FOUND PROPERTY		B - JEWELRY/PRECIOUS METALS	E - OFFICE EQUIPMENT	H - HOUSEHOLD GOODS	K - MISCELLANEOUS
				C - CLOTHING/FURS	F - ELECTRONIC EQUIPMENT	I - CONSUMABLE GOODS	
CODE	ITEM #	QTY	ITEM NAME	MAKE	MODEL / CALIBER	ID / SERIAL NUMBER	
PROP AFFIL	ADDITIONAL INFORMATION						
CODE	ITEM #	QTY	ITEM NAME	MAKE	MODEL / CALIBER	ID / SERIAL NUMBER	
PROP AFFIL	ADDITIONAL INFORMATION						
CODE	ITEM #	QTY	ITEM NAME	MAKE	MODEL / CALIBER	ID / SERIALNUMBER	
PROP AFFIL	ADDITIONAL INFORMATION						
CODE	ITEM #	QTY	ITEM NAME	MAKE	MODEL / CALIBER	ID / SERIAL NUMBER	
PROP AFFIL	ADDITIONAL INFORMATION						
CODE	ITEM #	QTY	ITEM NAME	MAKE	MODEL / CALIBER	ID / SERIALNUMBER	
PROP AFFIL	ADDITIONAL INFORMATION						
CODE	ITEM #	QTY	ITEM NAME	MAKE	MODEL / CALIBER	ID / SERIAL NUMBER	
PROP AFFIL	ADDITIONAL INFORMATION						
CODE	ITEM #	QTY	ITEM NAME	MAKE	MODEL / CALIBER	ID / SERIAL NUMBER	
PROP AFFIL	ADDITIONAL INFORMATION						
CODE	ITEM #	QTY	ITEM NAME	MAKE	MODEL / CALIBER	ID / SERIALNUMBER	
PROP AFFIL	ADDITIONAL INFORMATION						
CODE	ITEM #	QTY	ITEM NAME	MAKE	MODEL / CALIBER	ID / SERIAL NUMBER	
PROP AFFIL	ADDITIONAL INFORMATION						
CODE	ITEM #	QTY	ITEM NAME	MAKE	MODEL / CALIBER	ID / SERIALNUMBER	
PROP AFFIL	ADDITIONAL INFORMATION						
CODE	ITEM #	QTY	ITEM NAME	MAKE	MODEL / CALIBER	ID / SERIAL NUMBER	
PROP AFFIL	ADDITIONAL INFORMATION						
CODE	ITEM #	QTY	ITEM NAME	MAKE	MODEL / CALIBER	ID / SERIAL NUMBER	
PROP AFFIL	ADDITIONAL INFORMATION						

PROPERTY / EVIDENCE REPORT

VENTURA COUNTY SHERIFF'S DEPARTMENT
AGENCY IDENTIFIER CA0560000

1 CONNECTING REPORT NUMBERS —	2 RD 9072	3 BEAT 9601	4 RB NUMBER 06-7540
----------------------------------	--------------	----------------	------------------------

5 PROPERTY TYPE: <input checked="" type="checkbox"/> EVIDENCE <input type="checkbox"/> FOUND <input type="checkbox"/> SAFEKEEPING	6 <input type="checkbox"/> Misdemeanor <input checked="" type="checkbox"/> Felony	7 DATE OF INCIDENT 11/14/06
--	--	--------------------------------

8 INCIDENT / OFFENSE(S) (List all probable cause offenses pertaining to this RB.)
245(a)(1) P.C.

CODE: V - Victim S - Suspect A - Arrestee F - Finder O - Owner R - Reporting Party (Use Same Codes in Property Affiliation Boxes.)

CODE 11	11 NAME (Last, First, Middle, Gen.) / FIRM NAME V MATHEWS, SHANE	AKA / Moniker	RACE 12	SEX 13	14 DOB	15 BUSINESS PHONE
16 RESIDENCE ADDRESS / (<input type="checkbox"/> Same as Box # _____)						17 RESIDENCE PHONE
CONFIDENTIAL						() —
/						
24 NARRATIVE						
SAVE THE BELOW LISTED ITEM AS EVIDENCE						

35 PROPERTY / EVIDENCE INFORMATION

LOCATION BOOKED: Ventura E.C. SEARCH WARRANT? Yes No FINDER WISHES TO CLAIM? Yes No

36 PROPERTY CLASSIFICATION CODES

E - EVIDENCE	RC - RECOVERED PROPERTY	A - CURRENCY NOTES	D - VEHICLE	G - FIREARMS	J - LIVESTOCK
SK - SAFEKEEPING	FP - FOUND PROPERTY	B - JEWELRY/PRECIOUS METALS	E - OFFICE EQUIPMENT	H - HOUSEHOLD GOODS	K - MISCELLANEOUS
		C - CLOTHING/FURS	F - ELECTRONIC EQUIPMENT	I - CONSUMABLE GOODS	

CODE	ITEM #	QTY	ITEM NAME	MAKE	MODEL / CALIBER	ID / SERIAL NUMBER
W/K	1	1	C.D.	—	—	—

CODE	ITEM #	QTY	ITEM NAME	MAKE	MODEL / CALIBER	ID / SERIAL NUMBER
PROP AFFIL ADDITIONAL INFORMATION						

CODE	ITEM #	QTY	ITEM NAME	MAKE	MODEL / CALIBER	ID / SERIAL NUMBER
PROP AFFIL ADDITIONAL INFORMATION						

37 DATE AND TIME OF REPORT 11-16-06, 1645 hrs.	38 REPORTING OFFICER / ID NO. / DIV / UNIT L. Alvarez / 2886 / ECPS, OCT.	39 APPROVED BY / ID NO. <i>[Signature]</i> 3121
---	--	--

40 COPIES TO DET / MC NARC GANG / SEU STATS PRESS DOJ COURT OTHER

**PROPERTY / EVIDENCE
REPORT**

VENTURA COUNTY SHERIFF'S DEPARTMENT

AGENCY IDENTIFIER CA0560000

Page 2 of _____

4) RB NUMBER

PROPERTY CLASSIFICATION CODES				PROPERTY CODES							
E - EVIDENCE SK - SAFEKEEPING		RC - RECOVERED PROPERTY FP - FOUND PROPERTY		A - CURRENCY/NOTES B - JEWELRY/PRECIOUS METALS C - CLOTHING/FURS		D - VEHICLE E - OFFICE EQUIPMENT F - ELECTRONIC EQUIPMENT		G - FIREARMS H - HOUSEHOLD GOODS I - CONSUMABLE GOODS		J - LIVESTOCK K - MISCELLANEOUS	
CODE	ITEM #	QTY	ITEM NAME	MAKE	MODEL / CALIBER	ID / SERIAL NUMBER					
PROP AFFIL	ADDITIONAL INFORMATION										
CODE	ITEM #	QTY	ITEM NAME	MAKE	MODEL / CALIBER	ID / SERIAL NUMBER					
PROP AFFIL	ADDITIONAL INFORMATION										
CODE	ITEM #	QTY	ITEM NAME	MAKE	MODEL / CALIBER	ID / SERIALNUMBER					
PROP AFFIL	ADDITIONAL INFORMATION										
CODE	ITEM #	QTY	ITEM NAME	MAKE	MODEL / CALIBER	ID / SERIAL NUMBER					
PROP AFFIL	ADDITIONAL INFORMATION										
CODE	ITEM #	QTY	ITEM NAME	MAKE	MODEL / CALIBER	ID / SERIAL NUMBER					
PROP AFFIL	ADDITIONAL INFORMATION										
CODE	ITEM #	QTY	ITEM NAME	MAKE	MODEL / CALIBER	ID / SERIALNUMBER					
PROP AFFIL	ADDITIONAL INFORMATION										
CODE	ITEM #	QTY	ITEM NAME	MAKE	MODEL / CALIBER	ID / SERIAL NUMBER					
PROP AFFIL	ADDITIONAL INFORMATION										
CODE	ITEM #	QTY	ITEM NAME	MAKE	MODEL / CALIBER	ID / SERIALNUMBER					
PROP AFFIL	ADDITIONAL INFORMATION										
CODE	ITEM #	QTY	ITEM NAME	MAKE	MODEL / CALIBER	ID / SERIAL NUMBER					
PROP AFFIL	ADDITIONAL INFORMATION										
CODE	ITEM #	QTY	ITEM NAME	MAKE	MODEL / CALIBER	ID / SERIAL NUMBER					
PROP AFFIL	ADDITIONAL INFORMATION										
CODE	ITEM #	QTY	ITEM NAME	MAKE	MODEL / CALIBER	ID / SERIAL NUMBER					
PROP AFFIL	ADDITIONAL INFORMATION										

PROPERTY / EVIDENCE REPORT

VENTURA COUNTY SHERIFF'S DEPARTMENT

AGENCY IDENTIFIER CA0560000

Page 1 of 1

1 CONNECTING REPORT NUMBERS		2 RD 9072		3 BEAT 9601		4 RB NUMBER 06-30492	
5 PROPERTY TYPE: <input checked="" type="checkbox"/> EVIDENCE <input type="checkbox"/> FOUND <input type="checkbox"/> SAFEKEEPING				6 <input type="checkbox"/> Misdemeanor <input checked="" type="checkbox"/> Felony		7 DATE OF INCIDENT 11-14-06	
8 INCIDENT / OFFENSE(S) (List all probable cause offenses pertaining to this RB.) 245(A)(1) PC / ADW							
CODE: V - Victim S - Suspect A - Arrestee F - Finder O - Owner R - Reporting Party (Use Same Codes in Property Affiliation Boxes.)							
9 CODE 10 V	11 NAME (Last, First, Middle, Gen.) / FIRM NAME MATTHEWS, SHANE			12 RACE WM	13 SEX M	14 DOB —	15 BUSINESS PHONE (805) 494-8227
16 RESIDENCE ADDRESS / (<input type="checkbox"/> Same as Box # _____) CONFIDENTIAL (USD DEPUTY)				CITY	STATE	ZIP	17 RESIDENCE PHONE () —
18 CODE	19 NAME (Last, First, Middle, Gen.) / FIRM NAME			20 RACE	21 SEX	22 DOB	23 BUSINESS PHONE ()
24 RESIDENCE ADDRESS / (<input type="checkbox"/> Same as Box # _____)				CITY	STATE	ZIP	25 RESIDENCE PHONE ()
26 CODE	27 NAME (Last, First, Middle, Gen.) / FIRM NAME			28 RACE	29 SEX	30 DOB	31 BUSINESS PHONE ()
32 RESIDENCE ADDRESS / (<input type="checkbox"/> Same as Box # _____)				CITY	STATE	ZIP	33 RESIDENCE PHONE ()
34 NARRATIVE BELOW LISTED C.D. CONTAINS INTERVIEWS OF VARIOUS RESIDENTS AT [REDACTED] AND [REDACTED]							
35 PROPERTY / EVIDENCE INFORMATION							
LOCATION BOOKED: Ventura <input checked="" type="checkbox"/> E.C.				SEARCH WARRANT? Yes <input type="checkbox"/> No <input checked="" type="checkbox"/>		FINDER WISHES TO CLAIM? Yes <input type="checkbox"/> No <input checked="" type="checkbox"/>	
36 PROPERTY CLASSIFICATION CODES E - EVIDENCE RC - RECOVERED PROPERTY SK - SAFEKEEPING FP - FOUND PROPERTY				PROPERTY CODES A - CURRENCY/NOTES D - VEHICLE G - FIREARMS J - LIVESTOCK B - JEWELRY/PRECIOUS METALS E - OFFICE EQUIPMENT H - HOUSEHOLD GOODS K - MISCELLANEOUS C - CLOTHING/FURS F - ELECTRONIC EQUIPMENT I - CONSUMABLE GOODS			
CODE	ITEM #	QTY	ITEM NAME	MAKE	MODEL / CALIBER	ID / SERIAL NUMBER	
E/F	1	1	COMPACT DISC				
PROP AFFIL	ADDITIONAL INFORMATION — INTERVIEWS FROM NEIGHBORHOOD CANVASS						
CODE	ITEM #	QTY	ITEM NAME	MAKE	MODEL / CALIBER	ID / SERIAL NUMBER	
PROP AFFIL	ADDITIONAL INFORMATION						
CODE	ITEM #	QTY	ITEM NAME	MAKE	MODEL / CALIBER	ID / SERIAL NUMBER	
PROP AFFIL	ADDITIONAL INFORMATION						
37 DATE AND TIME OF REPORT 11-15-06/1005		38 REPORTING OFFICER / ID NO. / DIV / UNIT SAGELY / 2484/ECPS/INV.			39 APPROVED BY / ID NO. D. Serrano 524		
40 COPIES TO <input type="checkbox"/> DET / MC <input type="checkbox"/> NARC <input type="checkbox"/> GANG / SEU <input type="checkbox"/> STATS <input type="checkbox"/> PRESS <input type="checkbox"/> DOJ <input type="checkbox"/> COURT <input type="checkbox"/> OTHER							

PROPERTY / EVIDENCE REPORT

VENTURA COUNTY SHERIFF'S DEPARTMENT

AGENCY IDENTIFIER CA0560000

Page 1 of 1

1 CONNECTING REPORT NUMBERS _____		2 RD 9072	3 BEAT 96	4 RB NUMBER 06-30492
--------------------------------------	--	--------------	--------------	-------------------------

5 PROPERTY TYPE: <input checked="" type="checkbox"/> EVIDENCE <input type="checkbox"/> FOUND <input type="checkbox"/> SAFEKEEPING	6 <input type="checkbox"/> Misdemeanor <input type="checkbox"/> Felony	7 DATE OF INCIDENT 11-14-06
--	---	--------------------------------

8 INCIDENT / OFFENSE(S) (List all probable cause offenses pertaining to this RB.)
OFFICER INVOLVED SHOOTING

CODE: V - Victim S - Suspect A - Arrestee F - Finder O - Owner R - Reporting Party (Use Same Codes in Property Affiliation Boxes.)

13 NAME OF PARTY TO WHOM PROPERTY BELONGS

14 ADDRESS / (Same as Box # _____) CITY STATE ZIP

24 RESIDENCE ADDRESS / (Same as Box # _____) CITY STATE ZIP 25 RESIDENCE PHONE
()

26 CODE 27 NAME (Last, First, Middle, Gen.) / FIRM NAME AKA / Moniker RACE SEX 30 DOB 31 BUSINESS PHONE
()

32 RESIDENCE ADDRESS / (Same as Box # _____) CITY STATE ZIP 33 RESIDENCE PHONE
()

34 NARRATIVE
THE BELOW LISTED ITEM WAS BOOKED AS EVIDENCE.

35 PROPERTY / EVIDENCE INFORMATION

LOCATION BOOKED: <input type="checkbox"/> Ventura <input type="checkbox"/> E.C. _____	SEARCH WARRANT? Yes <input type="checkbox"/> No <input type="checkbox"/>	FINDER WISHES TO CLAIM? Yes <input type="checkbox"/> No <input type="checkbox"/>
---	---	---

36 PROPERTY CLASSIFICATION CODES

E - EVIDENCE	RC - RECOVERED PROPERTY	A - CURRENCY/NOTES	D - VEHICLE	G - FIREARMS	J - LIVESTOCK
SK - SAFEKEEPING	FP - FOUND PROPERTY	B - JEWELRY/PRECIOUS METALS	E - OFFICE EQUIPMENT	H - HOUSEHOLD GOODS	K - MISCELLANEOUS
		C - CLOTHING/FURS	F - ELECTRONIC EQUIPMENT	I - CONSUMABLE GOODS	

CODE	ITEM #	QTY	ITEM NAME	MAKE	MODEL / CALIBER	ID / SERIAL NUMBER
EF	1	1	TAPE	-	-	-

PROP AFFL: P ADDITIONAL INFORMATION: TAPE OF [REDACTED] STATEMENTS

CODE	ITEM #	QTY	ITEM NAME	MAKE	MODEL / CALIBER	ID / SERIAL NUMBER
/						

PROP AFFL: ADDITIONAL INFORMATION:

CODE	ITEM #	QTY	ITEM NAME	MAKE	MODEL / CALIBER	ID / SERIAL NUMBER
/						

PROP AFFL: ADDITIONAL INFORMATION:

37 DATE AND TIME OF REPORT 11-15-06 / 0614	38 REPORTING OFFICER / ID NO. / DIV / UNIT HAWTHORNE / 3384 / CCPS	39 APPROVED BY / ID NO. [Signature] / 2486
---	---	---

40 COPIES TO DET / MC NARC GANG / SEU STATS PRESS DCJ COURT OTHER

PROPERTY / EVIDENCE REPORT

VENTURA COUNTY SHERIFF'S DEPARTMENT

AGENCY IDENTIFIER CA0560000

Page 1 of 1

CONNECTING REPORT NUMBERS		2 RD 9072	3 BEAT 961	4 RB NUMBER 06-30492
---------------------------	--	--------------	---------------	-------------------------

5 PROPERTY TYPE: <input checked="" type="checkbox"/> EVIDENCE <input type="checkbox"/> FOUND <input type="checkbox"/> SAFEKEEPING	6 <input type="checkbox"/> Misdemeanor <input type="checkbox"/> Felony	7 DATE OF INCIDENT 11.14.06
--	---	--------------------------------

8 INCIDENT / OFFENSE(S) (List all probable cause offenses pertaining to this RB): Officer Involved Shooting	9 LOCATION OF INCIDENT (STREET ADDRESS AND CITY): [REDACTED]
--	---

CODE: V - Victim S - Suspect A - Arrestee F - Finder O - Owner R - Reporting Party (Use Same Codes in Property Affiliation Boxes.)

11 NAME (Last, First, Middle, Gen.) / FIRM NAME S.I. CANLEY, ADRIAN DOYLE	AKA / Moniker	15 BUSINESS PHONE ()
--	---------------	--------------------------

16 RESIDENCE ADDRESS / (<input type="checkbox"/> Same as Box # _____)	CITY	STATE	ZIP	17 RESIDENCE PHONE ()
---	------	-------	-----	---------------------------

19 NAME (Last, First, Middle, Gen.) / FIRM NAME	AKA / Moniker	RACE	SEX	22 DOB	23 BUSINESS PHONE ()
---	---------------	------	-----	--------	--------------------------

24 RESIDENCE ADDRESS / (<input type="checkbox"/> Same as Box # _____)	CITY	STATE	ZIP	25 RESIDENCE PHONE ()
---	------	-------	-----	---------------------------

27 NAME (Last, First, Middle, Gen.) / FIRM NAME	AKA / Moniker	RACE	SEX	30 DOB	31 BUSINESS PHONE ()
---	---------------	------	-----	--------	--------------------------

32 RESIDENCE ADDRESS / (<input type="checkbox"/> Same as Box # _____)	CITY	STATE	ZIP	33 RESIDENCE PHONE ()
---	------	-------	-----	---------------------------

34 NARRATIVE

SEE ORIGINAL CRIME REPORT, SAME R.B. NUMBER. SEE SUPPLEMENTAL REPORT AUTHORED BY ME REFERENCE THIS EVIDENCE FOR DETAILS, SAME R.B. NUMBER.

35 PROPERTY / EVIDENCE INFORMATION

LOCATION BOCKED: Ventura <input checked="" type="checkbox"/> E.C.	SEARCH WARRANT? Yes <input type="checkbox"/> No <input checked="" type="checkbox"/>	FINDER WISHES TO CLAIM? Yes <input type="checkbox"/> No <input checked="" type="checkbox"/>
---	---	---

36 PROPERTY CLASSIFICATION CODES E - EVIDENCE RC - RECOVERED PROPERTY SK - SAFEKEEPING FP - FOUND PROPERTY	PROPERTY CODES A - CURRENCY/NOTES D - VEHICLE G - FIREARMS J - LIVESTOCK B - JEWELRY/PRECIOUS METALS E - OFFICE EQUIPMENT H - HOUSEHOLD GOODS K - MISCELLANEOUS C - CLOTHING/FURS F - ELECTRONIC EQUIPMENT I - CONSUMABLE GOODS
--	--

CODE E F	ITEM # 1	QTY 1	ITEM NAME CASSETTE	MAKE MAXELL	MODEL / CALIBER MC-60UR	ID / SERIAL NUMBER -
----------------	-------------	----------	-----------------------	----------------	----------------------------	-------------------------

PROF. AFFIL. ADDITIONAL INFORMATION
- INTERVIEWS WITH RESIDENTS

CODE	ITEM #	QTY	ITEM NAME	MAKE	MODEL / CALIBER	ID / SERIAL NUMBER
------	--------	-----	-----------	------	-----------------	--------------------

PROF. AFFIL. ADDITIONAL INFORMATION

CODE	ITEM #	QTY	ITEM NAME	MAKE	MODEL / CALIBER	ID / SERIAL NUMBER
------	--------	-----	-----------	------	-----------------	--------------------

PROF. AFFIL. ADDITIONAL INFORMATION

37 DATE AND TIME OF REPORT 11.14.06/2216	38 REPORTING OFFICER / ID NO. / DIV / UNIT S. COLLINS / 13219 / EC15 / 961	39 APPROVED BY / ID NO. A. [Signature]
---	---	---

40 COPIES TO: DET / MC NARC GANG / SEU STATS PRESS DOJ COURT OTHER

**PROPERTY / EVIDENCE
REPORT**

VENTURA COUNTY SHERIFF'S DEPARTMENT

AGENCY IDENTIFIER CA0560000

Page 2 of _____

41 RB NUMBER

PROPERTY CLASSIFICATION CODES				PROPERTY CODES			
E - EVIDENCE		RC - RECOVERED PROPERTY		A - CURRENCY/NOTES	D - VEHICLE	G - FIREARMS	J - LIVESTOCK
SK - SAFEKEEPING		FP - FOUND PROPERTY		B - JEWELRY/PRECIOUS METALS	E - OFFICE EQUIPMENT	H - HOUSEHOLD GOODS	K - MISCELLANEOUS
				C - CLOTHING/FURS	F - ELECTRONIC EQUIPMENT	I - CONSUMABLE GOODS	
CODE	ITEM #	QTY	ITEM NAME	MAKE	MODEL / CALIBER	ID / SERIAL NUMBER	
PROP AFFIL	ADDITIONAL INFORMATION						
CODE	ITEM #	QTY	ITEM NAME	MAKE	MODEL / CALIBER	ID / SERIAL NUMBER	
PROP AFFIL	ADDITIONAL INFORMATION						
CODE	ITEM #	QTY	ITEM NAME	MAKE	MODEL / CALIBER	ID / SERIALNUMBER	
PROP AFFIL	ADDITIONAL INFORMATION						
CODE	ITEM #	QTY	ITEM NAME	MAKE	MODEL / CALIBER	ID / SERIAL NUMBER	
PROP AFFIL	ADDITIONAL INFORMATION						
CODE	ITEM #	QTY	ITEM NAME	MAKE	MODEL / CALIBER	ID / SERIAL NUMBER	
PROP AFFIL	ADDITIONAL INFORMATION						
CODE	ITEM #	QTY	ITEM NAME	MAKE	MODEL / CALIBER	ID / SERIALNUMBER	
PROP AFFIL	ADDITIONAL INFORMATION						
CODE	ITEM #	QTY	ITEM NAME	MAKE	MODEL / CALIBER	ID / SERIAL NUMBER	
PROP AFFIL	ADDITIONAL INFORMATION						
CODE	ITEM #	QTY	ITEM NAME	MAKE	MODEL / CALIBER	ID / SERIAL NUMBER	
PROP AFFIL	ADDITIONAL INFORMATION						
CODE	ITEM #	QTY	ITEM NAME	MAKE	MODEL / CALIBER	ID / SERIAL NUMBER	
PROP AFFIL	ADDITIONAL INFORMATION						
CODE	ITEM #	QTY	ITEM NAME	MAKE	MODEL / CALIBER	ID / SERIAL NUMBER	
PROP AFFIL	ADDITIONAL INFORMATION						

SEARCH WARRANT
PROPERTY RECORD

VENTURA COUNTY SHERIFF'S DEPARTMENT
NCIC / CII CA0560000

1 SEARCH WARRANT NO.

2 CASE NO.
06-30492

LOCATION SEARCHED: WHITE 1999 FORD F-150 [REDACTED]

PAGE 1 OF 1

3. EVIDENCE SEIZED PURSUANT TO SEARCH WARRANT

4. DATE / TIME: 10/16/06 1545
5. PD: 3999
6. BEAT: 15

7. ITEM NO. 1
8. PERSON PROPERTY BOOKED TO (Last Name, First, Middle, Gen.)
9. STORAGE LOCATION: HEADQUARTERS
10. EVIDENCE / WORK REQUESTED

11. LOCATION WHERE PROPERTY FOUND OR TAKEN INTO CUSTODY:
CD CASE BEHIND FRONT PASSENGER SEAT

12. PROPERTY: Itemized, Detailed Description of Same, Including Color, Size, Serial Number, Etc..
3 COMPACT DISCS

13. OFFICER LOCATING PROPERTY / I.D. NO. R. DAVIDSON 2775
14. PHOTO YES NO
15. SEIZED / 11470 H & S YES NO
16. OFFICER SEIZING PROPERTY / ID. NO. R. DAVIDSON 2775
17. OFFICER BOOKING PROPERTY R. DAVIDSON 2775

18. ITEM NO. 2
19. PERSON PROPERTY BOOKED TO (Last Name, First, Middle, Gen.)
20. STORAGE LOCATION: HEADQUARTERS
21. EVIDENCE / WORK REQUESTED

22. LOCATION WHERE PROPERTY FOUND OR TAKEN INTO CUSTODY:
23. PROPERTY: Itemized, Detailed Description of Same, Including Color, Size, Serial Number, Etc..
MISC. ITEMS OF DOMINION & CONTROL - ELECTRIC BILL, RETIREMENT STATEMENT,
SUPERIOR COURT MINUTE ORDER

24. OFFICER LOCATING PROPERTY / I.D. NO. R. DAVIDSON 2775
25. PHOTO YES NO
26. SEIZED / 11470 H & S YES NO
27. OFFICER SEIZING PROPERTY / ID. NO. R. DAVIDSON 2775
28. OFFICER BOOKING PROPERTY R. DAVIDSON 2775

29. ITEM NO. 3
30. PERSON PROPERTY BOOKED TO (Last Name, First, Middle, Gen.)
31. STORAGE LOCATION: HEADQUARTERS
32. EVIDENCE / WORK REQUESTED

33. LOCATION WHERE PROPERTY FOUND OR TAKEN INTO CUSTODY:
INSIDE REAR TAILGATE
34. PROPERTY: Itemized, Detailed Description of Same, Including Color, Size, Serial Number, Etc..
EXPENDED BULLET & JACKET

35. OFFICER LOCATING PROPERTY / I.D. NO. R. DAVIDSON 2775
36. PHOTO YES NO
37. SEIZED / 11470 H & S YES NO
38. OFFICER SEIZING PROPERTY / ID. NO. R. DAVIDSON 2775
39. OFFICER BOOKING PROPERTY

40. ITEM NO. 4
41. PERSON PROPERTY BOOKED TO (Last Name, First, Middle, Gen.)
42. STORAGE LOCATION: HEADQUARTERS
43. EVIDENCE / WORK REQUESTED

44. LOCATION WHERE PROPERTY FOUND OR TAKEN INTO CUSTODY:
BEHIND BACKREST OF REAR SEAT
45. PROPERTY: Itemized, Detailed Description of Same, Including Color, Size, Serial Number, Etc..
EXPENDED BULLET

46. OFFICER LOCATING PROPERTY / I.D. NO. R. DAVIDSON 2775
47. PHOTO YES NO
48. SEIZED / 11470 H & S YES NO
49. OFFICER SEIZING PROPERTY / ID. NO. R. DAVIDSON 2775
50. OFFICER BOOKING PROPERTY

51. ITEM NO. 5
52. PERSON PROPERTY BOOKED TO (Last Name, First, Middle, Gen.)
53. STORAGE LOCATION: HEADQUARTERS
54. EVIDENCE / WORK REQUESTED

55. LOCATION WHERE PROPERTY FOUND OR TAKEN INTO CUSTODY:
FRONT BUMPER
56. PROPERTY: Itemized, Detailed Description of Same, Including Color, Size, Serial Number, Etc..
EXPENDED BULLET

57. OFFICER LOCATING PROPERTY / I.D. NO. R. DAVIDSON 2775
58. PHOTO YES NO
59. SEIZED / 11470 H & S YES NO
60. OFFICER SEIZING PROPERTY / ID. NO. R. DAVIDSON 2775
61. OFFICER BOOKING PROPERTY

62. LIST ALL DEFENDANTS AND CHARGES (Last Name, First, D.O.B., Code Section(s))
ITEMS 3, 4, 5 RELEASED TO FORENSIC FIREARMS EXAMINER [REDACTED]

63. REPORTING OFFICER - I.D. NO. / DIV. / UNIT
W. AYUB / 3318 / SPEC. SVC. / MC

64. APPROVED BY / I.D. NO.

PROPERTY / EVIDENCE REPORT

VENTURA COUNTY SHERIFF'S DEPARTMENT
AGENCY IDENTIFIER CA0560000

Ham A

1 CONNECTING REPORT NUMBERS		2 RD 9072	3 BEAT 9G01	4 RB NUMBER 06-30492
-----------------------------	--	--------------	----------------	-------------------------

5 INCIDENT / OFFENSE(S) (List all probable cause offenses pertaining to this RB.) OFFICER INVOLVED SHOOTING	6 <input type="checkbox"/> Misdemeanor <input type="checkbox"/> Felony	7 DATE OF INCIDENT 11-14-2006
--	---	----------------------------------

8 LOCATION OF INCIDENT (STREET ADDRESS AND CITY) [REDACTED] THOUSAND OAKS	9 STOLEN PROPERTY VALUE TOTAL
--	-------------------------------

10 CODE S	11 NAME (Last, First, Middle, Gen.) / FIRM NAME CANLEY, ADRIAN	AKA/Moniker	12 RACE -	13 SEX M	14 DOB [REDACTED]	15 BUSINESS PHONE .. / ..
15 RESIDENCE ADDRESS / (<input type="checkbox"/> Same as Box # _____)			CITY	STATE	ZIP	17 RESIDENCE PHONE - / -
18 CODE V	19 NAME (Last, First, Middle, Gen.) / FIRM NAME MATTHEWS, SHANE (ID #3127)	AKA/Moniker	20 RACE W	21 SEX M	22 DOB -	23 BUSINESS PHONE .. / ..
24 RESIDENCE ADDRESS / (<input type="checkbox"/> Same as Box # _____)			CITY	STATE	ZIP	25 RESIDENCE PHONE - / -
25 CODE	27 NAME (Last, First, Middle, Gen.) / FIRM NAME	AKA/Moniker	28 RACE	29 SEX	30 DOB	31 BUSINESS PHONE /
32 RESIDENCE ADDRESS / (<input type="checkbox"/> Same as Box # _____)			CITY	STATE	ZIP	33 RESIDENCE PHONE /

A NARRATIVE

On 12/18/2006, at approximately 1200 hours I arrived at the Property Room Warehouse. I took photos of the Ford F150, (license [REDACTED]) I processed the exterior drivers door and window for fingerprints. I obtained four fingerprint cards of possible value.

I downloaded 5 photos.

35 LOCATION BOOKED: <input checked="" type="checkbox"/> CRIME LAB <input type="checkbox"/>	36 SEARCH WARRANT? <input type="checkbox"/> Yes <input type="checkbox"/> No	37 FINDER WISHES TO CLAIM? <input type="checkbox"/> Yes <input type="checkbox"/> No
--	---	---

38 PROPERTY CLASSIFICATION CODES SP - STOLEN PROPERTY SR - STOLEN / RECOVERED E - EVIDENCE SK - SAFEKEEPING LP - LOST PROPERTY RC - RECOVERED PROPERTY FP - FOUND PROPERTY T - TRANSACTION	PROPERTY CODES A - CURRENCY / NOTES B - JEWELRY / PRECIOUS METALS C - CLOTHING / FURS D - VEHICLES E - OFFICE EQUIPMENT F - ELECTRONIC EQUIPMENT G - FIREARMS H - HOUSEHOLD GOODS I - CONSUMABLE GOODS J - LIVESTOCK K - MISCELLANEOUS L - BIKE NOTE: ALL VEHICLES SHOULD ALSO BE ENTERED ON A CHP180 REPORT
--	---

CODES E K	ITEM # 1	QTY 1	ITEM NAME LATENT PRINTS	MAKE -	MODEL / CALIBER -	PROPERTY ROOM USE ONLY
PROP AFFILIATION			ID / SERIAL NUMBER	VALUE		

ADDITIONAL INFORMATION
LIFTED FROM THE DRIVERS WINDOW AND DOOR

CODES	ITEM #	QTY	ITEM NAME	MAKE	MODEL / CALIBER	PROPERTY ROOM USE ONLY
PROP AFFILIATION			ID / SERIAL NUMBER	VALUE		

ADDITIONAL INFORMATION

39 DATE AND TIME OF REPORT 12/18/2006 1400 hours	40 REPORTING OFFICER / ID NO. / DIV / UNIT [REDACTED] #4244 / Spec. Serv. / Crime Scene Inv. Unit
---	--

41 FTO OFFICER / ID NO. / DIV / UNIT	42 APPROVED BY / ID NO. / UNIT
--------------------------------------	--------------------------------

1 RD 9072	2 BEAT 9G01	3 RB NUMBER 06-30492
--------------	----------------	-------------------------

4 CODE	5 ITEM	6 QTY.	7 ITEM NAME	8 BRAND / MAKE MANUFACTURER	9 MODEL NAME OR NUMBER	10 MISC. DESCRIPTION	11 IDENTIFICATION / SERIAL NUMBER	12 VALUE
--------	--------	--------	-------------	-----------------------------	------------------------	----------------------	-----------------------------------	----------

Supplemental Case Cleared

Gang Domestic Hate Child Abuse Elderly Abuse

Connecting Report Numbers:

Code Section / Description: Officer Involved Shooting

Reclassify To:

Code: P Name: Canley, Adrian Doyle

Cellular Telephone Analysis

On 01/17/2007, I examined the electronic memory of the cellular telephone, which was found on Adrian Canley's person after he was shot during an altercation with Senior Deputy Shane Matthews. Canley's telephone was collected from the incident scene and placed into secure storage at the sheriff's east county property room.

Upon examining the telephone, I noted it was a flip-style Sanyo SCP-3100 cellular telephone with a color LCD display and an integrated camera. The telephone's assigned telephone number was [REDACTED] and service was provided by Sprint Spectrum PCS. There was an assigned e-mail address, which read [REDACTED]

I noted four images contained within the telephone's electronic memory. Two of the images appeared to be different views of the street from the front porch on [REDACTED]. Another image was the face of an approximately 3-year-old black female juvenile. The fourth image was completely blacked-out with no recognizable image.

I examined the cellular telephone's address book and noted the following four contacts stored there:



13 DATE / TIME OF REPORT 01/18/07/ 2:16 PM	14 REPORTING OFFICER / ID NO / CIV / UNIT Sgt. W. Ayub/#3318/Special Services	15 APPROVED BY / (ID) <i>[Signature]</i> #97SGI
---	--	--

NARRATIVE REPORT VENTURA COUNTY SHERIFF'S DEPARTMENT

Page 2 of 3

Continuation

AGENCY IDENTIFIER CA0560000

1 RD 9072	2 BEAT 9G01	3 RB NUMBER 06-30492
--------------	----------------	-------------------------

4 CODE	5 ITEM	6 QTY.	7 ITEM NAME	8 BRAND / MAKE MANUFACTURER	9 MODEL NAME OR NUMBER	10 MISC. DESCRIPTION	11 IDENTIFICATION / SERIAL NUMBER	12 VALUE
--------	--------	--------	-------------	-----------------------------	------------------------	----------------------	-----------------------------------	----------

Next, I examined the cellular telephone's calls log and I made and recorded the following observations:

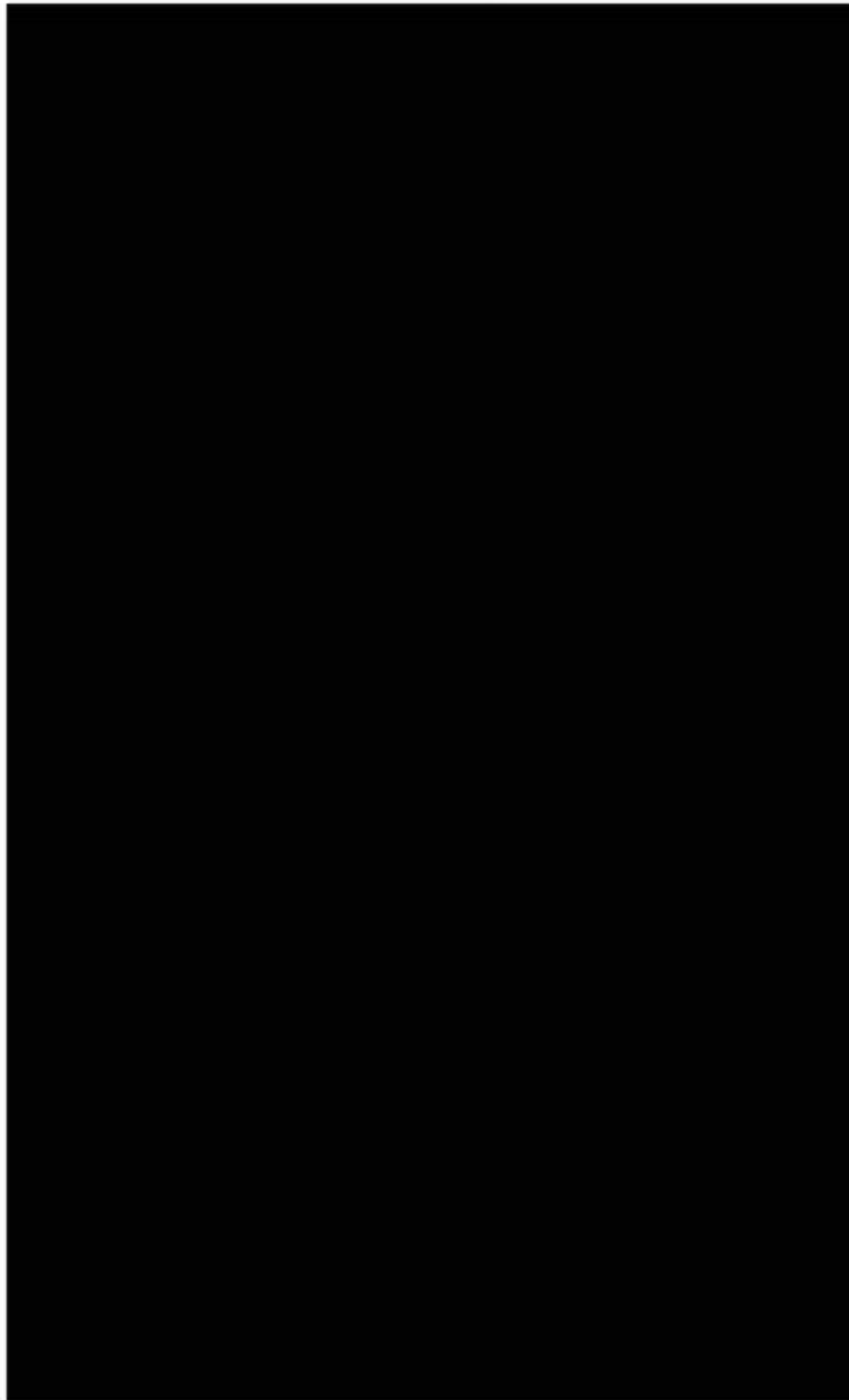

13 DATE / TIME OF REPORT 01/18/07/ 2:16 PM	14 REPORTING OFFICER / ID NO / DIV / UNIT Sgt. W. Ayub/#3318/Special Services <i>BA</i>	15 APPROVED BY / ID NO <i>[Signature]</i> #1917 <i>SEI</i>
---	--	---

NARRATIVE REPORT VENTURA COUNTY SHERIFF'S DEPARTMENT

Page 3 of 3

Continuation

AGENCY IDENTIFIER CA0560000

1 RD 9072	2 BEAT 9G01	3 RB NUMBER 06-30492
--------------	----------------	-------------------------

4 CODE	5 ITEM	6 QTY.	7 ITEM NAME	8 BRAND / MAKE MANUFACTURER	9 MODEL NAME OR NUMBER	10 MISC. DESCRIPTION	11 IDENTIFICATION / SERIAL NUMBER	12 VALUE
--------	--------	--------	-------------	-----------------------------	------------------------	----------------------	-----------------------------------	----------

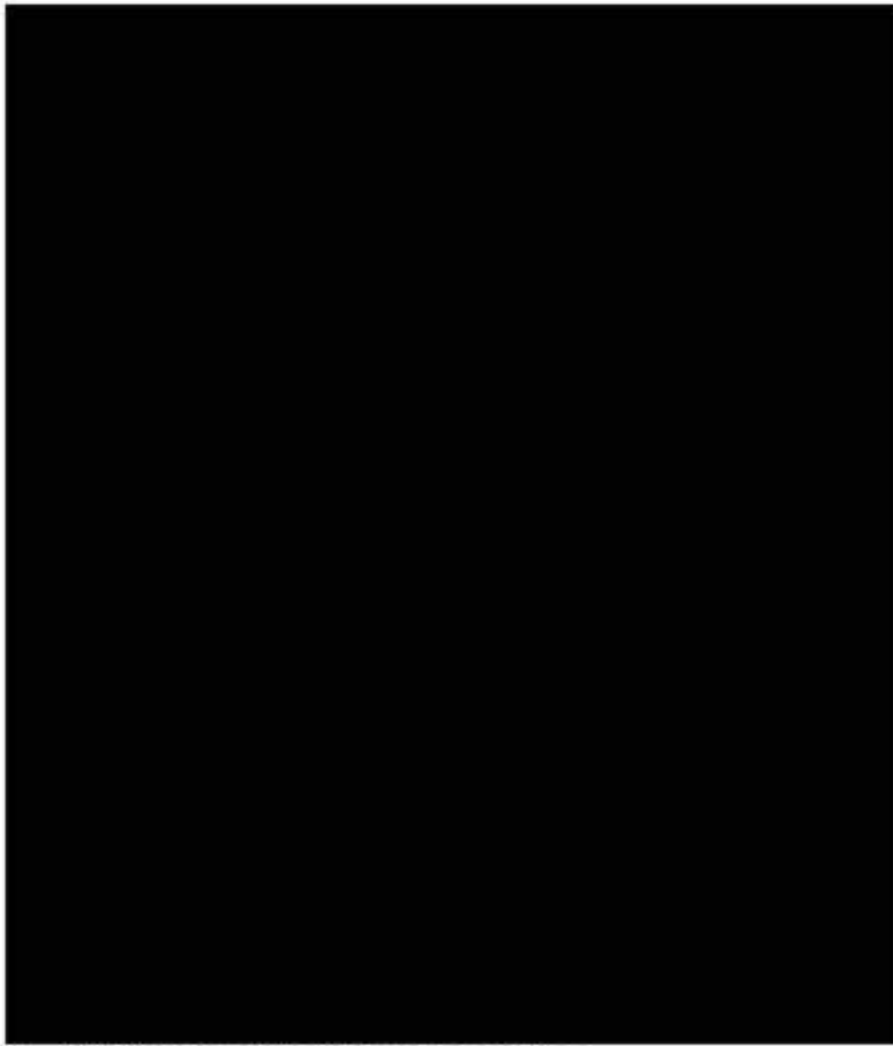

- * [REDACTED] Canley's cellular telephone number
- ** [REDACTED] [REDACTED]'s cellular telephone number

I concluded my examination of Canley's cellular telephone, and I repackaged and sealed the telephone in its original evidence bag. I returned the cellular telephone to the sheriff's property room on 01/18/07.

13 DATE / TIME OF REPORT 01/18/07/ 2:16 PM	14 REPORTING OFFICER / ID NO / DIV / UNIT BA Sgt. W. Ayub/#3318/Special Services	15 APPROVED BY / ID NO <i>[Signature]</i> #1917SGI
---	--	---

SHOTS
FIRED

Page 1 of 2

Los Angeles Police Department

COMBINED EVID. REPORT
 MULTIPLE DRS ON THIS REPORT

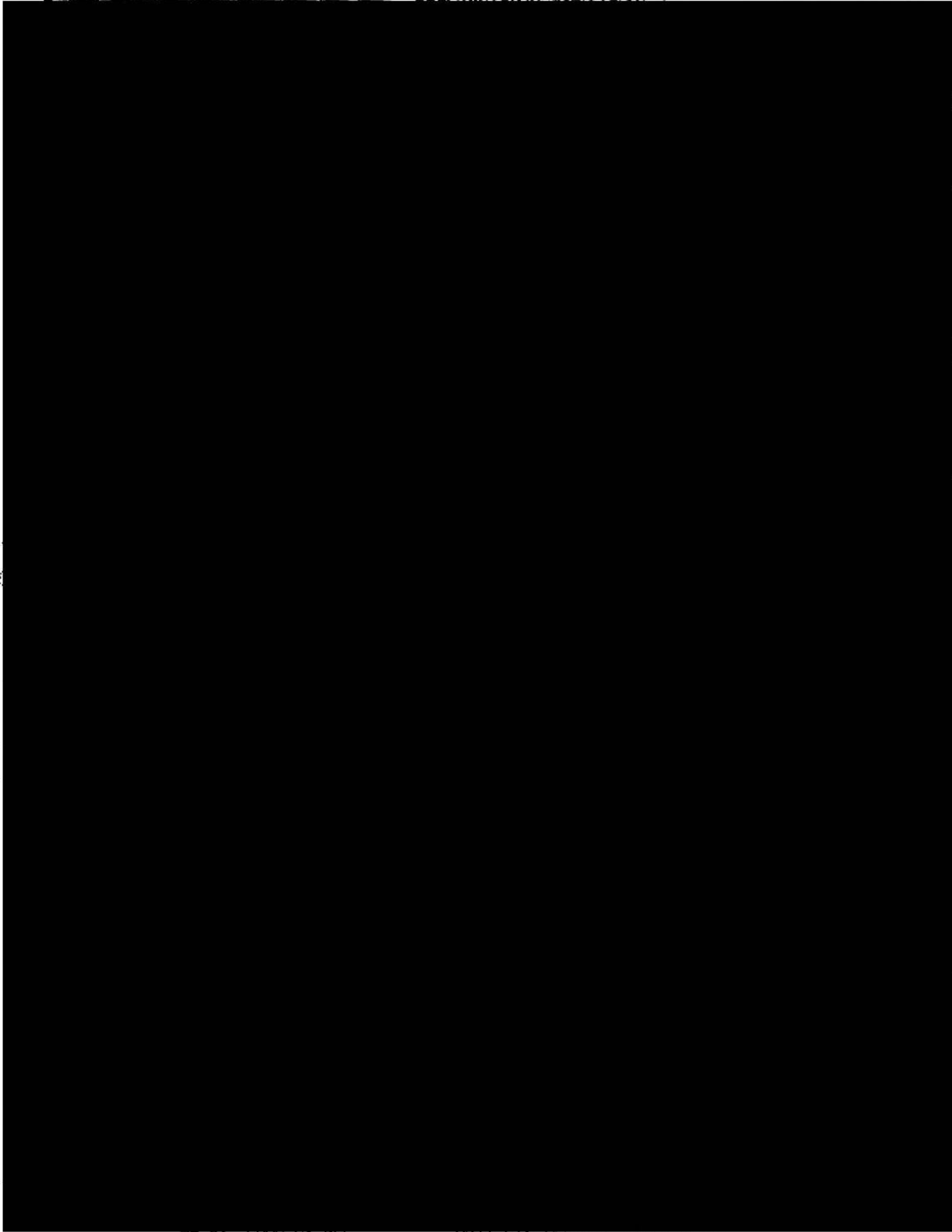

CONTINUATION SHEET

Los Angeles Police Department

PAGE NO. 2		TYPE OF REPORT Negligent Discharge Of A Firearm				BOOKING NO.		DR NO. 0610 22932	
ITEM NO.	QUANTITY	ARTICLE	SERIAL NO	BRAND	MODEL NO.	MISC DESCRIPTION (EG. COLOR, SIZE, INSCRIPTIONS, CALIBER, REVOLVER, ETC)			DOLLAR VALUE

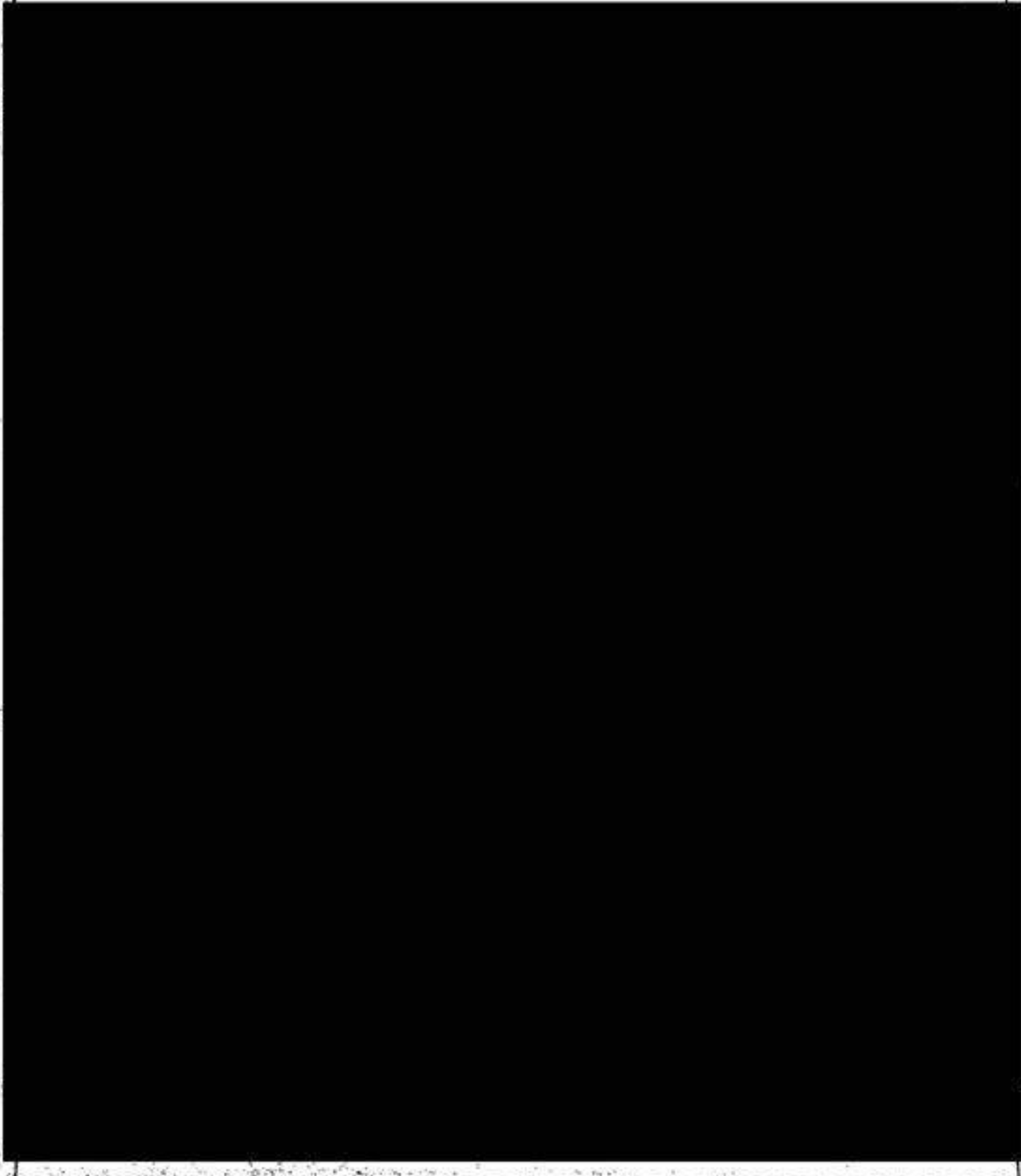

U.S. Department of Justice

Bureau of Alcohol, Tobacco, Firearms and Explosives

Office of Enforcement Programs and Services

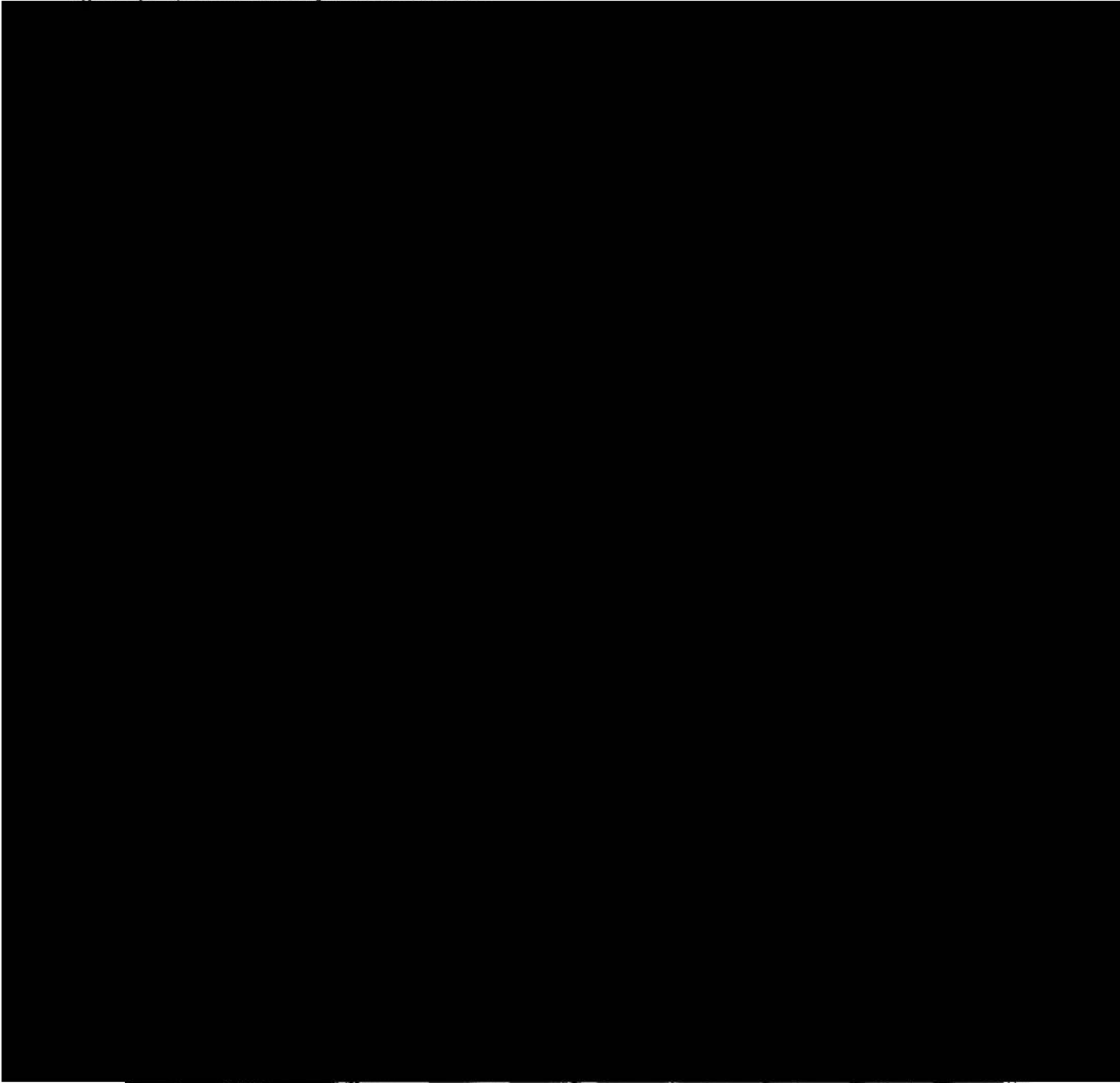

APPROPRIATIONS ACT OF 2006

Please be advised that H.R. 4818, the Consolidated Appropriations Act of 2006, severely restricts the disclosure of any part of the contents of the Firearms Tracing System or any information required to be kept by Federal Firearms Licensees pursuant to 18 USC 923(g), or required to be reported pursuant to 18 USC 923(g)(3) and 923(g)(7).

The information provided is for official use only and may not be disseminated outside of law enforcement agencies. The information should not be used for statistical representation without the prior approval of the Chief, National Tracing Center Division. We recommend that you discuss these restrictions with ATF legal counsel prior to disclosing any of the information provided in this correspondence outside of ATF.

DEPARTMENT OF JUSTICE
BUREAU OF ALCOHOL, TOBACCO, FIREARMS AND EXPLOSIVES
NATIONAL TRACING CENTER

Phone: (800) 788-7133 Fax: (800) 578-7223

Print Date: November 17, 2006



FIREARMS TRACE SUMMARY

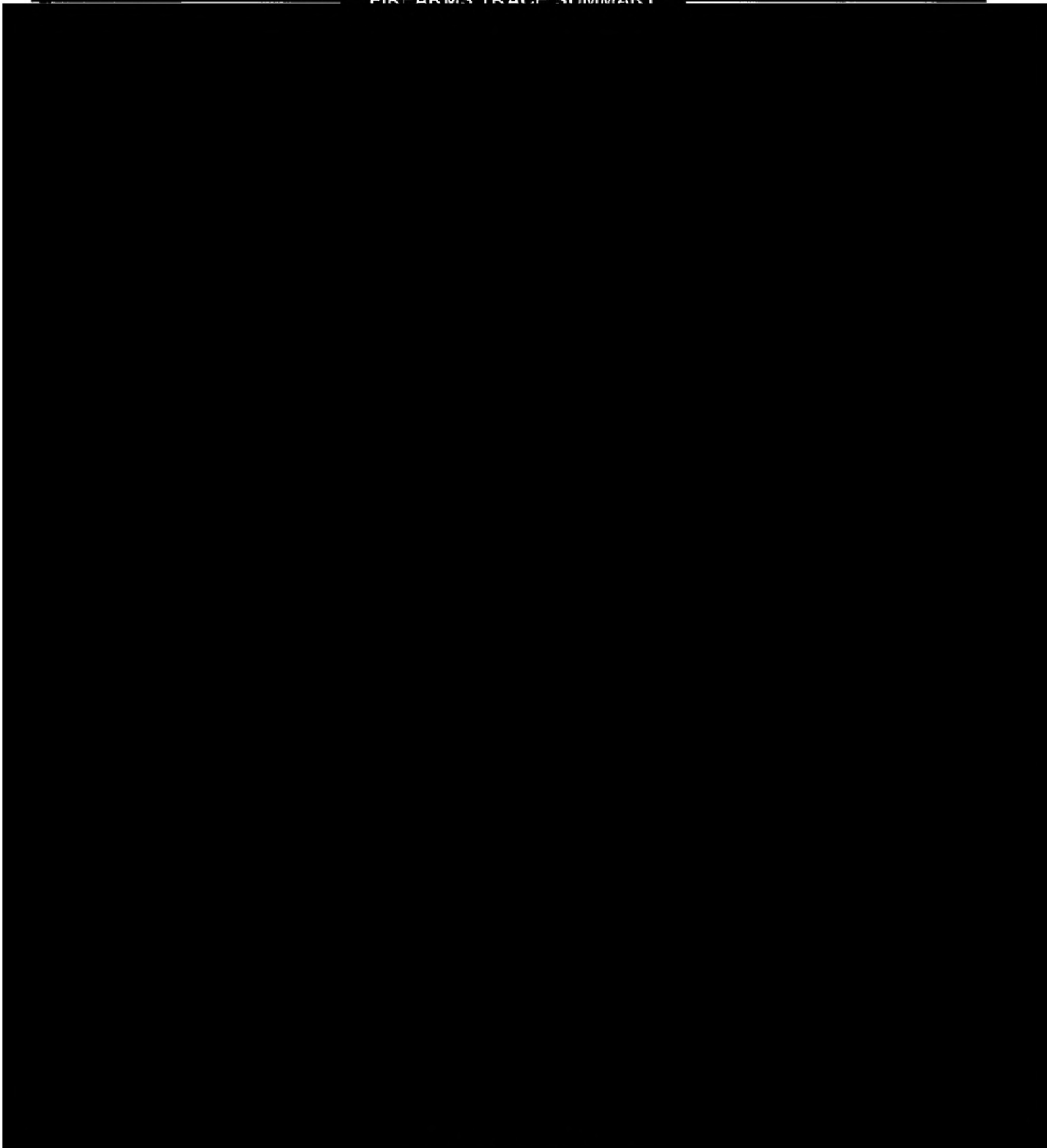

Dealer

FOR OFFICIAL USE ONLY

Individual

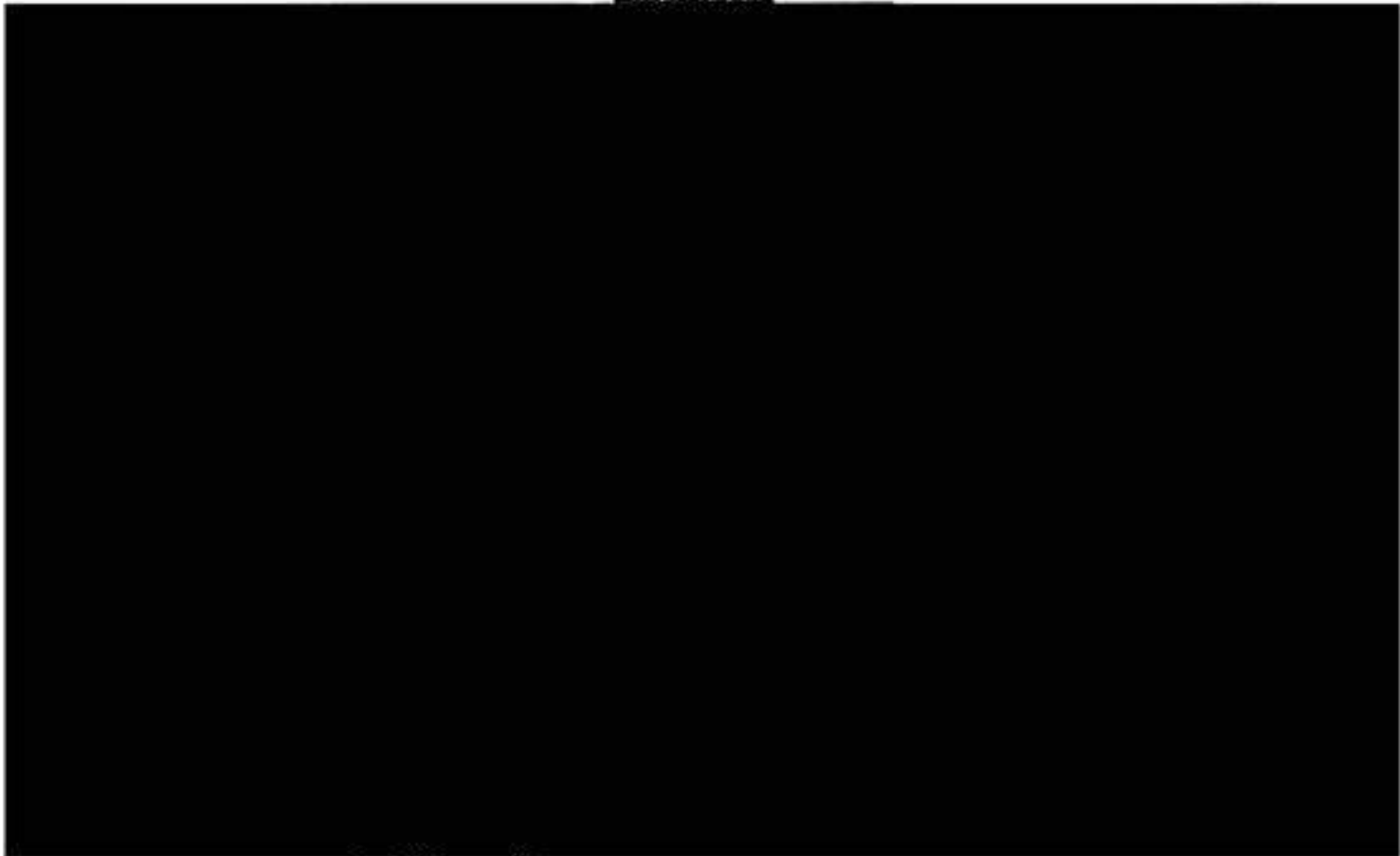

SECRET
NOT







HI-POINT FIREARMS

8611-A North Dixie Drive

Dayton, OH 45414

Phone: 1-877-425-4867

.45 ACP (also called 45 Automatic)

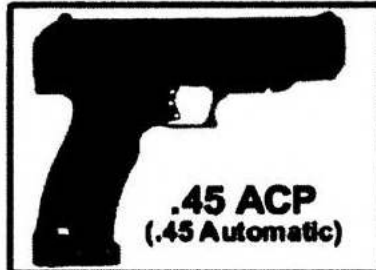

Suggested Retail Price: \$ 179.00

Caliber: .45 ACP (also called 45 Automatic)
Barrel Length: 4.5"
Overall Length: 7.72"
Weight: 32 Ounces
Frame: NEW Polymer Frame
Finish: Powder Coat (Black)
Sights: 3-dot, Fully adjustable rear sight (Windage an adjustable)
Magazine: 9 round capacity
 Last round lock open
 Quick on & off thumb safety
 Magazine disconnect safety

Furnished with a trigger lock at no extra charge.

Advantages of the .45 ACP Cartridge:

The .45 ACP cartridge is a long-proven military cartridge first brought into use in 1911 by the US Army; and still the standard or optional cartridge in hundreds of militaries over the globe, including the U.S. Special Operations. It uses some of the heaviest bullets in a semi-automatic up to 230 grains. It has been in use for over 80 years.

Due to the pressure and power that it generates, Hi-Point has built their .45 ACP on a larger frame to enable the shooter to enjoy shooting their firearm. Whether shooting bowling pins, hunting, or law enforcement, the .45 ACP has been doing the job since the turn of the century.

Advantages of the Polymer Frame

The Polymer frame used on the 9mm Compact offers the shooter several advantages. First, it decreases the weight of the weapon. Secondly, the forgiving nature of the polymer will decrease recoil when firing the weapon. The polymer frame that is used by Hi-Point is a very high-tech, durable material that will serve the shooter for decades to come.

To read what the industry magazines have to say about Hi-Point: [CLICK HERE!](#)

HI-POINT NEWS

Need a Holster for you HI-POINT Handgun?

To view our news archives:

[CLICK HERE](#)

[Home](#)

[Back to Previous Page](#)

[.380 COMP](#) | [.380 ACP](#) | [9MM COMPACT](#) | [9mm COMP](#) | [.40 S&W](#) | [.45 ACP](#)

Join our
E-mail Newsletter!

State:

(OT for outside N.America)



[Home](#) | [Handguns](#) | [Carbine](#) | [Firearm Safety](#) | [Find A Dealer](#) | [Links](#) | [Contact Us](#)

MKS Supply: Marketer of Hi-Point Firearms
8611-A North Dixie Drive
Dayton, OH 45414
Phone: 1-877-425-4867
Fax: (937) 454-0503
Email: info@mkssupply.com
INTRANET

+

Designed by:  Advc 
Powered by IC

Shown in "Safe" Position



MODEL JH 45 ACP

ALL FIREARMS ARE DANGEROUS PLEASE BE CAREFUL

We strongly advise that you familiarize yourself with all the mechanisms of this gun, or any gun, before putting any ammunition into it. *We also strongly advise that the yellow safety plug we provide be kept in the chamber during transportation or storage of this firearm. A new plug will be provided free of charge upon request.*

We provide reasonable care in the manufacture of this pistol, but assume no responsibility for its care, handling and use.

CAUTION

For your safety, and that of others, we strongly recommend that you do not store, carry or handle this, or any other firearm with a cartridge in the barrel until you are ready to shoot. A cartridge from the Magazine supply can be placed in the barrel, ready to shoot, in about the same length of time as required to move the Safety Slide from the "Safe" (S) position to the "Fire" position. Magazine capacity is seven cartridges.

BE CAREFUL!

CAUTIONS:

ALWAYS handle your pistol as if it were loaded, so that you never fire it accidentally when you think it is unloaded.

NEVER point your pistol at anything you do not intend to shoot so if it fires accidentally, injury, death or damage to property will be prevented.

NEVER take anyone's word that a gun is unloaded; check for yourself with fingers off the trigger and gun pointed in a safe direction, so that you never fire the gun accidentally when you think it is unloaded.

ALWAYS be sure barrel and action are clear of obstructions. Clean a fouled pistol immediately so that it will function correctly and safely.

NEVER squeeze the trigger or put your finger in the trigger guard until you are aiming at a target and ready to shoot. This will prevent you from firing the pistol when it is pointing in an unsafe direction.

NEVER put your finger on the trigger while cocking. (See "Loading the Pistol")

ALWAYS be absolutely sure of your target and the area behind it before you squeeze the trigger. A bullet could travel through or past your target up to 1-1/2 miles.....if in doubt, don't shoot.

NEVER leave a loaded pistol unattended. Someone, especially a child, may fire it and cause injury, death or damage to property.

NEVER use your pistol if it fails to function properly, and never force a jammed action, as a round may explode causing serious injury, possible death or severe damage to your pistol.

NEVER leave your pistol cocked, ready to fire, as this condition is extremely dangerous, and the pistol could easily be accidentally discharged, causing injury, death or damage to property.

NEVER leave the magazine partially in the handle. The magazine should either be completely inserted in the handle, with the magazine in its proper position or completely removed.

HI-POINT FIREARMS



MODEL JH 45 ACP

HASKELL MANUFACTURING INC.
585 EAST BLUE LICK ROAD
LIMA, OH 45801

STOP!

YOU MUST READ INSTRUCTION SHEET

Always keep it with the pistol. If you lend, give, or sell this pistol, be sure the instruction sheet goes with it. You can get a free instruction sheet from: **Hi-Point Firearms, Haskell Manufacturing Inc., 585 East Blue Lick Road, Lima, Ohio 45801, (419) 225-8297.**

GET INSTRUCTIONS FROM A COMPETENT FIREARM INSTRUCTOR BEFORE USING ANY GUN.

STATEMENT OF LIMITED WARRANTY

The Model JH 45 ACP is warranted to the original retail customer for life from date of original purchase against defects in material and/or workmanship. All parts and labor or replacement, at our option, are covered.

Transportation to and from repair facilities, damage caused by failure to perform normal maintenance, sales outside the United States, damage due to the use of high pressure, reloaded or other nonstandard ammunition, or any unauthorized repair, modification, misuse, abuse, or alteration of the product is not covered by this Limited Warranty.

Any implied warranties, including the implied warranties of merchantability and fitness for a particular purpose, are limited to one year from date of original retail purchase. Consequential or incidental damages or expenses, or any other expenses are not covered by this warranty.

TO OBTAIN SERVICE UNDER WARRANTY

Send your firearm to us via Priority Mail or UPS along with a photocopy of your proof of retail purchase freight charges prepaid. Be sure to include a statement as to the reason for return and make sure to include your complete return street address. Ship your product to the following address: **Hi-Point Firearms, Haskell Manufacturing Inc., 585 East Blue Lick Road, Lima, Ohio 45801.**

FOR FURTHER INFORMATION CONCERNING SHIPPING THROUGH THE U.S. MAIL AND UNITED PARCEL SERVICE, CALL 419-747-9444.

FOR BEST RESULTS USE JACKETED AMMUNITION.

PARTS LIST FOR MODEL JH 45 ACP

- | | |
|-----------------------|-----------------------------|
| 1. Ejection Pin | 14. Recoil Spring |
| 2. Ejection Key | 15. Trigger Pin |
| 3. Ejection Spring | 16. Trigger Assembly |
| 4. Slide | 17. Grip Screw (2) |
| 5. Firing Pin | 18. Grip (2) |
| 6. Firing Pin Spring | 19. Magazine Catch |
| 7. Slide Retainer | 20. Magazine Catch Spring |
| 8. Slide Retainer Pin | 21. Magazine Assembly |
| 9. Sear Spring | 22. Counterweight Hold Pin |
| 10. Sear Cam | 23. Counterweight Pivot Pin |
| 11. Sear Assembly | 24. Counterweight |
| 12. Safety | 25. Sear Block |
| 13. Frame | 26. Sear Block Spring |

Contact your local dealer for parts inquiry

To order extra magazines, send a \$15 money order (includes shipping & handling) per magazine to: **Haskell Manufacturing Inc., 585 East Blue Lick Road, Lima, Ohio 45801.**

Prices available upon request. Changes in design may occur from time to time. Always specify the serial number of your pistol with your inquiry.

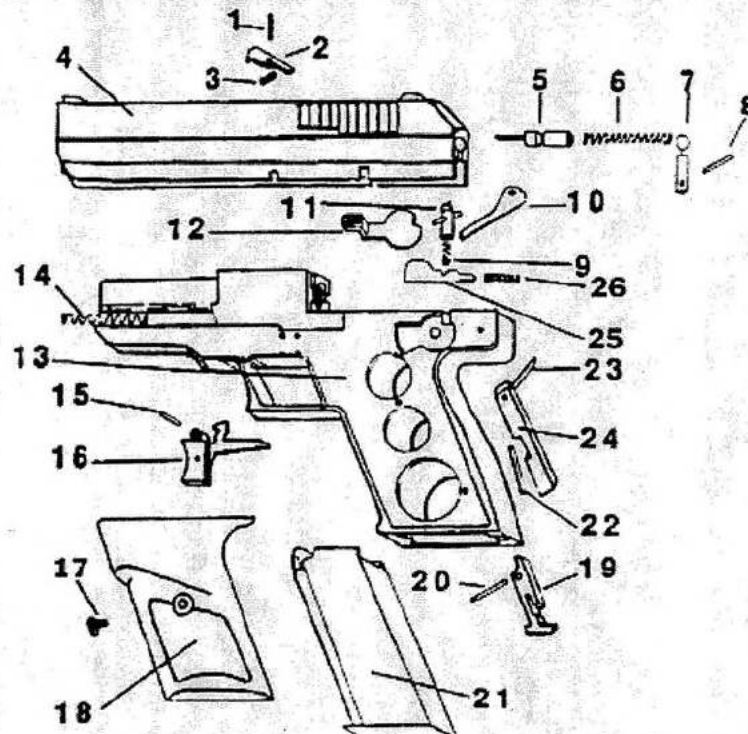

Safety/Slide Lock is located at top of left grip. Sliding safety lever upward, into slide notch engages safety, exposes letter (S) on grip and places pistol in "SAFE" position.

Sliding safety lever down, out of slide notch, places pistol in "Firing" position.

Slide can be locked open by moving slide to rearmost position and at this time pushing safety lever up into the notch in the slide. Breech, chamber, and barrel inspection or cleaning is easily performed in this position.

Safety is engaged **only** when lever is up in the slide notch, when lever is out of notch, pistol is in "Firing" position.

LOADING THE PISTOL: After loading your Magazine, insert it into the bottom of the handle and push it into the pistol as far as possible. When fully inserted, the Magazine Catch will hook over the bottom of the Magazine and hold it in its proper position. Take the pistol in one hand with a firm grip, making sure your fingers are not touching the trigger. **Point your pistol in a safe direction** and with your other hand firmly grasp the serrated portion of the Slide and pull it as far rearward as it will go. **RELEASE THE SLIDE FROM ITS REARMOST POSITION ALLOWING IT TO GO FORWARD ON ITS OWN ACCORD.** This procedure places the first cartridge into the chamber and the gun is ready for firing. Subsequent feeding and ejection operations are performed automatically until the pistol is empty.

CAUTION: UNLOAD YOUR PISTOL IF YOU DO NOT INTEND TO SHOOT IMMEDIATELY!

UNLOADING WITHOUT FIRING: Always point your pistol in a safe direction before attempting to unload it. To unload unfired cartridges, move the Magazine Catch rearward until the Magazine can be pulled from the pistol. **AFTER THE MAGAZINE IS REMOVED, PULL THE SLIDE TO THE REAR TO REMOVE THE CARTRIDGE FROM THE BARREL CHAMBER.** As a safety precaution, always check the Barrel chamber visually by holding the Slide back and looking into the Slide, Chamber and Magazine cavities.

DISASSEMBLY

Pistol must be unloaded to perform disassembly. Move slide to rearmost position. Allow slide to move forward 1/8 inch, exposing slide retainer pin. Using a 1/8 pin punch, remove retainer pin from frame. Lift slide up until it stops. Hold rear of slide up and push forward; this removes slide assembly from frame. Reassemble by reversing disassembly procedure.

**ALL FIREARMS ARE DANGEROUS
PLEASE BE CAREFUL**

ATTENTION

This handgun is classified by the A.T.F. Division of the Internal Revenue Service, U.S. Treasury Dept. as a firearm or dangerous weapon and is released by **Hi-Point Firearms, Haskell Manufacturing Inc.** with the express understanding that **Hi-Point Firearms, Haskell Manufacturing Inc.** is not responsible and assumes no liability in any manner whatsoever for injury, death, or damage to property resulting from either intentional or accidental discharge of this handgun, or from its function when used for purposes or subjected to treatment for which it was not designed. **Hi-Point Firearms, Haskell Manufacturing Inc.** will not honor claims involving this firearm which result from any or a combination of any of the following:

- Improper, careless or unsafe handling.
- Use of the wrong caliber ammunition.
- Use of ammunition, other than original high quality commercially manufactured ammunition, in good condition.
- Unauthorized adjustments, repairs or alterations.
- Corrosion or neglect.
- Other influences beyond our direct and immediate control.

Hi-Point Firearms, Haskell Manufacturing Inc. will not honor any claim whatsoever by second or any subsequent owner of this firearm.

Hi-Point Firearms, Haskell Manufacturing Inc. will not be held liable for any injury or damages to any person resulting from the use of this firearm for any purpose, including civil defense, police activity, hunting dangerous game, or combat.

This statement of liability supersedes any other statement of liability, whether expressed or implied.

HI-POINT FIREARMS

by HASKELL MANUFACTURING, INC.

585 East Blue Lick Road
Lima, Ohio 45801
(419) 225-8297

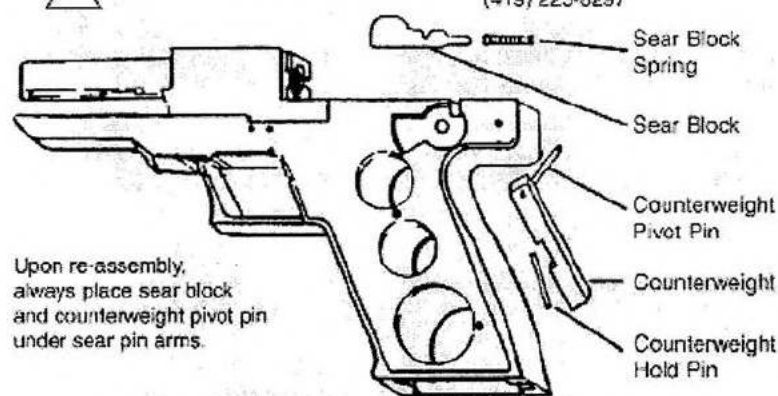

NOTE: When installing sear pin, ramp on top of sear pin faces to the front of handgun.

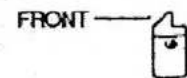

To print this page, select **File** then **Print** from your browser

URL: http://www.venturacountystar.com/vcs/co_valley/article/0,1375,VCS_166_5144925,00.html

Deputy shoots, kills man. [REDACTED]

By Star staff

November 15, 2006

Authorities have identified a Santa Paula man as the victim of the Ventura County Sheriff's Department's first officer-involved shooting of the year.

Adrian Canley, [REDACTED] was shot and killed during a confrontation with a plain-clothed detective Tuesday night. The incident occurred at an apartment complex in the [REDACTED] around 6:20 p.m.

The detective, whom department officials were refusing to identify Wednesday, had been at the complex investigating an unrelated non-violent crime at the time of the deadly confrontation, Capt. Ron Nelson said.

Canley confronted the detective in an "agitated state," and verbally acknowledged the detective was a law enforcement officer with the Sheriff's Department, Nelson said.

Canley then got into a pickup truck and attempted to run over the detective.

The detective repeatedly warned Canley to stop and, believing his life was in danger, fired several shots at the advancing truck, Nelson said.

While the detective and additional responding patrol deputies were administering first aid to Canley, they discovered that he had a loaded handgun in his waistband.

Canley was taken to Los Robles Hospital & Medical Center where he died shortly after arrival, Nelson said.

All officer-involved shootings dictate separate investigations by the department's Major Crimes Unit, the department's Internal Affairs Unit and the District Attorney's Office. The investigations are expected to take several months, Nelson said.

Copyright 2006, Ventura County Star. All Rights Reserved.

To print this page, select **File** then **Print** from your browser

URL: http://www.venturacountystar.com/vcs/co_valley/article/0,1375,VCS_166_5150565,00.html

Deputy involved in shooting identified; cousin describes man killed

By Jean Ortiz, jortiz@VenturaCountyStar.com

November 17, 2006

More details emerged Thursday about the Ventura County Sheriff's Department detective and the Santa Paula man he fatally shot during a confrontation in Thousand Oaks this week.

Senior Deputy Shane Matthews, an 11-year veteran, fired the shots that killed Adrian Canley, [REDACTED] in an apartment complex parking lot Tuesday night, sheriff's Capt. Ron Nelson said.

The Thousand Oaks-based detective, who was not in uniform, was investigating an unrelated crime at the [REDACTED] apartments in the [REDACTED] when the 6:20 p.m. altercation occurred.

Matthews was interviewing a man in connection with a nonviolent crime when Canley approached in an "agitated state," authorities said. After identifying the plainclothes detective as a law enforcement officer, Canley got into a pickup truck and allegedly tried to run over the detective.

Matthews repeatedly warned Canley and, feeling threatened, fired his .40-caliber gun several times, fatally striking Canley in the chest. While administering first aid, deputies found a loaded handgun in Canley's waistband, Nelson said.

But details of the violent confrontation seemed out of character for a man described by a family member as humble, quiet and "always smiling."

A troubled man who would seek to inflict harm on someone else is not how [REDACTED] Canley remembered his shy cousin.

"I really didn't see nothing like that in his character," the Lompoc man said.

[REDACTED] Canley last saw his cousin about nine months ago and recalled his enduring elation about becoming a new father to a girl, who is now going on 3 years old, he said.

"It seems like his spirits were high the last time I seen him," he said.

Adrian Canley was not married, said [REDACTED] Canley, who was unfamiliar with his cousin's occupation or interests.

He did recall, however, the year he lived with Canley's family in San Jose in the late 1980s while attending San Jose State University. He spent the time trying to serve as a good role model to his younger cousin, even treating Adrian and his two siblings to pizza every Tuesday if they kept up their grades and did their chores.

He'd never seen his cousin act violently or "out of the ordinary," [REDACTED] Canley said.

"He was always smiling and very kinda quiet — shy in a sense," he said.

Officials will piece together details of Tuesday night over the next several months, including looking into why

the Santa Paula man was at the Thousand Oaks complex, Nelson said.

All officer-involved shootings dictate separate investigations by the department's Major Crimes Unit, the department's Internal Affairs Unit and the District Attorney's Office. The investigations are expected to take several months, Nelson said.

Because of the investigations, it's unclear how much detail the department will share with the public, he said.

Officials say there is no relationship between Canley and the man the detective was interviewing immediately before the altercation. That person has cooperated as a witness and isn't necessarily the only witness to the confrontation, Nelson said.

Several residents reported hearing the shots and at least one heard someone saying "stop, stop" before the shots were fired.

Residents, shocked about the events, characterized the complex as quiet. Predominantly families fill the two- and three-bedroom units at the [REDACTED], they said.

The Sheriff's Department declined to release any additional details Thursday. The department delayed releasing Matthews' name until Thursday because it wanted to ensure that the detective knew that his identity would be made public, Nelson said.

The incident was the department's first officer-involved shooting this year. From 2004, only one other person has died as a result of a shot fired by a deputy. The department, however, logged five fatal officer-involved shootings in 2003, including two in Thousand Oaks.

The department provides police services in the cities of Camarillo, Moorpark, Thousand Oaks, Fillmore and Ojai as well as unincorporated areas of the county.

Copyright 2006, Ventura County Star. All Rights Reserved.

PROPERTY / EVIDENCE REPORT

VENTURA COUNTY SHERIFF'S DEPARTMENT
 AGENCY IDENTIFIER CA0560000

1 CONNECTING REPORT NUMBERS		2 RD 9072	3 BEAT 9601	4 RB NUMBER 06-30492
5 PROPERTY TYPE: <input checked="" type="checkbox"/> EVIDENCE <input type="checkbox"/> FOUND <input type="checkbox"/> SAFEKEEPING		6 <input type="checkbox"/> Misdemeanor <input type="checkbox"/> Felony		7 DATE OF INCIDENT 11/14/2006
8 INCIDENT / OFFENSE(S) (List all probable cause offenses pertaining to this RB.) OFFICER INVOLVED SHOOTING		9 LOCATION OF INCIDENT (STREET ADDRESS AND CITY)		
CODE: V - Victim S - Suspect A - Arrestee F - Finder O - Owner R - Reporting Party (Use Same Codes in Property Affiliation Boxes.)				
10 CODE P	11 NAME (Last, First, Middle, Gen.) / FIRM NAME CANLEY, ADRIAN	12 AKA / Moniker	13 RACE HM	14 SEX M
15 BUSINESS PHONE ()		16 RESIDENCE ADDRESS / (<input type="checkbox"/> Same as Box # _____)		17 RESIDENCE PHONE ()
18 CODE 19 NAME (Last, First, Middle, Gen.) / FIRM NAME		20 AKA / Moniker	21 RACE	22 SEX
23 BUSINESS PHONE ()		24 RESIDENCE ADDRESS / (<input type="checkbox"/> Same as Box # _____)		25 RESIDENCE PHONE ()
26 CODE 27 NAME (Last, First, Middle, Gen.) / FIRM NAME		28 AKA / Moniker	29 RACE	30 SEX
31 BUSINESS PHONE ()		32 RESIDENCE ADDRESS / (<input type="checkbox"/> Same as Box # _____)		33 RESIDENCE PHONE ()
34 NARRATIVE				
35 PROPERTY / EVIDENCE INFORMATION				
LOCATION BOOKED: Ventura E.C.		SEARCH WARRANT? Yes <input type="checkbox"/> No <input checked="" type="checkbox"/>		FINDER WISHES TO CLAIM? Yes <input type="checkbox"/> No <input checked="" type="checkbox"/>
36 PROPERTY CLASSIFICATION CODES E - EVIDENCE SK - SAFEKEEPING RC - RECOVERED PROPERTY FP - FOUND PROPERTY		PROPERTY CODES A - CURRENCY/NOTES B - JEWELRY/PRECIOUS METALS C - CLOTHING/FURS D - VEHICLE E - OFFICE EQUIPMENT F - ELECTRONIC EQUIPMENT G - FIREARMS H - HOUSEHOLD GOODS I - CONSUMABLE GOODS J - LIVESTOCK K - MISCELLANEOUS		
CODE E/K	ITEM # 1	QTY 2	ITEM NAME AUDIO RECORDINGS	MAKE
PROP AFFIL		ADDITIONAL INFORMATION (2) COMPACT DISCS CONTAINING DIGITAL AUDIO RECORDINGS		
CODE	ITEM #	QTY	ITEM NAME	MAKE
PROP AFFIL		ADDITIONAL INFORMATION		
CODE	ITEM #	QTY	ITEM NAME	MAKE
PROP AFFIL		ADDITIONAL INFORMATION		
37 DATE AND TIME OF REPORT 03/19/07 1230		38 REPORTING OFFICER / ID NO. / DIV / UNIT W. AVULB / 3318 / SPEC. SVC. / M.C.		39 APPROVED BY / ID NO. <i>[Signature]</i>
40 COPIES TO <input type="checkbox"/> DET / MC <input type="checkbox"/> NARC <input type="checkbox"/> GANG / SEU <input type="checkbox"/> STATS <input type="checkbox"/> PRESS <input type="checkbox"/> DOJ <input type="checkbox"/> COURT <input type="checkbox"/> OTHER				

**PROPERTY / EVIDENCE
REPORT**

VENTURA COUNTY SHERIFF'S DEPARTMENT

AGENCY IDENTIFIER CA0560000

Page 2 of _____

41 RB NUMBER

PROPERTY CLASSIFICATION CODES				PROPERTY CODES			
E - EVIDENCE SK - SAFEKEEPING		RC - RECOVERED PROPERTY FP - FOUND PROPERTY		A - CURRENCY/NOTES B - JEWELRY/PRECIOUS METALS C - CLOTHING/FURS	D - VEHICLE E - OFFICE EQUIPMENT F - ELECTRONIC EQUIPMENT	G - FIREARMS H - HOUSEHOLD GOODS I - CONSUMABLE GOODS	J - LIVESTOCK K - MISCELLANEOUS
CODE	ITEM #	QTY	ITEM NAME	MAKE	MODEL / CALIBER	ID / SERIAL NUMBER	
PROP AFFIL	ADDITIONAL INFORMATION						
CODE	ITEM #	QTY	ITEM NAME	MAKE	MODEL / CALIBER	ID / SERIAL NUMBER	
PROP AFFIL	ADDITIONAL INFORMATION						
CODE	ITEM #	QTY	ITEM NAME	MAKE	MODEL / CALIBER	ID / SERIALNUMBER	
PROP AFFIL	ADDITIONAL INFORMATION						
CODE	ITEM #	QTY	ITEM NAME	MAKE	MODEL / CALIBER	ID / SERIAL NUMBER	
PROP AFFIL	ADDITIONAL INFORMATION						
CODE	ITEM #	QTY	ITEM NAME	MAKE	MODEL / CALIBER	ID / SERIALNUMBER	
PROP AFFIL	ADDITIONAL INFORMATION						
CODE	ITEM #	QTY	ITEM NAME	MAKE	MODEL / CALIBER	ID / SERIAL NUMBER	
PROP AFFIL	ADDITIONAL INFORMATION						
CODE	ITEM #	QTY	ITEM NAME	MAKE	MODEL / CALIBER	ID / SERIALNUMBER	
PROP AFFIL	ADDITIONAL INFORMATION						
CODE	ITEM #	QTY	ITEM NAME	MAKE	MODEL / CALIBER	ID / SERIAL NUMBER	
PROP AFFIL	ADDITIONAL INFORMATION						
CODE	ITEM #	QTY	ITEM NAME	MAKE	MODEL / CALIBER	ID / SERIALNUMBER	
PROP AFFIL	ADDITIONAL INFORMATION						
CODE	ITEM #	QTY	ITEM NAME	MAKE	MODEL / CALIBER	ID / SERIAL NUMBER	
PROP AFFIL	ADDITIONAL INFORMATION						
CODE	ITEM #	QTY	ITEM NAME	MAKE	MODEL / CALIBER	ID / SERIAL NUMBER	
PROP AFFIL	ADDITIONAL INFORMATION						

NARRATIVE REPORT VENTURA COUNTY SHERIFF'S DEPARTMENT

Page 1 of 2

Continuation

AGENCY IDENTIFIER CA0560000

1 PD 9072	2 BEAT 9G01	3 RB NUMBER 06-30492
--------------	----------------	-------------------------

4 CODE	5 ITEM	6 QTY.	7 ITEM NAME	8 BRAND / MAKE MANUFACTURER	9 MODEL NAME OR NUMBER	10 MISC. DESCRIPTION	11 IDENTIFICATION / SERIAL NUMBER	12 VALUE
--------	--------	--------	-------------	-----------------------------	------------------------	----------------------	-----------------------------------	----------

- Supplemental Case Cleared
 Gang Domestic Hate Child Abuse Elderly Abuse

Connecting Report Numbers:

Code Section / Description: Officer Involved Shooting

Reclassify To:

Code: P **Name:** Canley, Adrian Doyle



On 02/26/07, at about 1738 hours, I telephoned [REDACTED] [REDACTED] concerning her knowledge of the events leading to the officer-involved shooting of Adrian Canley. Canley was [REDACTED]'s ex-boyfriend and the father of her child.

I spoke with [REDACTED] briefly after Detective Rob Davidson and I interviewed Canley's mother, [REDACTED], at [REDACTED] in Santa Paula. At that time, I told [REDACTED] I wanted to speak with her at a later time regarding this incident. [REDACTED] agreed to speak with me, and she provided me with her cellular telephone number.

I dialed [REDACTED]'s cellular telephone number, and a female answered my call. I asked for [REDACTED], and the female confirmed she was [REDACTED]. I identified myself to [REDACTED], and I confirmed with her that she recalled speaking with me after I interviewed Canley's mother. I told [REDACTED] that I wanted to meet with her and discuss this incident. [REDACTED] told me that she preferred to speak with me in person rather than over the telephone. [REDACTED] and I agreed to meet at the East County sheriff's station on Thursday, 03/01/07, at 1730 hours. I provided [REDACTED] with my contact telephone number in the event she could not keep our appointment.

13 DATE / TIME OF REPORT 03/19/07/ 11:02 AM	14 REPORTING OFFICER / ID NO / DIV / UNIT Sgt. W. Ayub/#3318/Special Services	15 APPROVED BY / ID NO [Signature] #1917SEL
--	--	--

NARRATIVE REPORT VENTURA COUNTY SHERIFF'S DEPARTMENT

Page 2 of 2 Continuation

AGENCY IDENTIFIER CA0560000

1 RD	2 BEAT	3 RB NUMBER
9072	9G01	06-30492

4 CODE	5 ITEM	6 QTY.	7 ITEM NAME	8 BRAND / MAKE MANUFACTURER	9 MODEL NAME OR NUMBER	10 MISC. DESCRIPTION	11 IDENTIFICATION / SERIAL NUMBER	12 VALUE
--------	--------	--------	-------------	-----------------------------	------------------------	----------------------	-----------------------------------	----------

On 02/27/07, I retrieved a telephone message [REDACTED] left on my office's voicemail system. In her message, [REDACTED] told me she forgot to mention that she had retained an attorney on behalf of Adrian Canley and their daughter. [REDACTED] suggested that I call her attorney at [REDACTED]

On 03/01/07, at about 0940 hours, I placed another telephone call to [REDACTED] cellular telephone. I received [REDACTED]'s voicemail, and I left a message asking [REDACTED] for confirmation that she was, in fact, canceling the appointment we had made to speak this afternoon. I left my telephone number, and I asked [REDACTED] to call me. [REDACTED] did not return my telephone call, and she did not keep the appointment.

13 DATE / TIME OF REPORT 03/19/07/ 11:02 AM	14 REPORTING OFFICER / ID NO. / DIV / UNIT Sgt. W. Ayub/#3318/Special Services	15 APPROVED BY / ID NO. [Signature] #1911SGI
--	---	---

REQUEST FOR TAPE REPRODUCTION

(Applies to Sheriff's Radio and Telephone Communications only)

(MANDATORY INFORMATION)

Sheriff's Report No. 06-30492 Date/Time of Incident 11/14/06 1821

Location of Incident [REDACTED] THOUSAND OAKS

Specify Streets and Addresses _____

Geographical Area or City _____

Purpose of Request INVESTIGATION

Tape Reproduction of: Radio Telephone Call Number of Recordings 3

Date/Time (Inclusive) of Recording 11/14/06 1815 - 1850

Defendant's Name(s) CANLEY, ADRIAN

Officer(s) by Car/Beat Assignment(s) ST3, 9J51, 9RS1, 9H21

Additional Instructions/Information/Requests _____

Person Requesting SGT. BILL AYUB [Signature]
PRINT NAME SIGNATURE
VCSD - MAJOR CRIMES 477-7019 11/17/2006
BUSINESS OR FIRM PHONE NUMBER DATE OF REQUEST

NOTE: All requests for Tape Reproductions will require a MINIMUM of two(2) working days.

PAYMENT: The Board of Supervisors requires that an appropriate fee be charged for this service. At the time you submit your request for Tape Reproduction you will be given an estimated cost for the service. The actual cost to complete your request will be based on the time required. Payment by cash or check payable to "Ventura County Sheriff" must be received prior to releasing the Tape Reproduction(s).

FOR OFFICIAL USE ONLY

Date/Time Request Received 11-17-06 1500

Employee Claudia L. Tolmie 2286
NAME AND ID NUMBER

Date Reproduction Completed 11/18/06

Reproduction Completed by CRONAN 4225
NAME, RANK AND ID NUMBER

[Signature]
SIGNATURE

Date Reproduction Released 11/19/06

Time Reproduction Released 0600

Released to (Print) _____

SIGNATURE

Amount Paid _____

Cash Check

Receipt Number or Check Number _____

INCIDENT HISTORY DETAIL: S063180557

INITIATE: 18:20:25 11/14/06 CALL NUMBER: S0557
 ENTRY: 18:21:02 CURRENT STATUS: CLOSED
 DISPATCH: 18:21:27 PRIMARY UNIT: 9B21
 ONSCENE: 18:24:27 CASE NUMBER: S00600030492
 CLOSE: 02:37:48 11/15/06 DISPOSITION: RPT

LOCATION: [REDACTED], TO (DINSMORE CT & N CONEJO SCHOOL RD)

LOCATION COMMENTS:

DAREA: EAST
 BEAT: 9G01 MAP PAGE: 556-J1 TYPE: SHOTS SHOTS FIRED
 RD: 9072 PRIORITY: E (IN-PROGRESS)
 PRIORS

18:21:02 R011 ENTRY TEXT:CODE3 RP HEARD 6 SHOTS IPO LOC AND NOW HEARS
 18:21:02 R011 E911 SUBJS ARGUING //NO FURTHER \RPT PRTY:Y \SOURCE:RESD

18:21:02 R011 PRIOR SP Ssubj 06/03/06 @ 00:58:44
 18:21:27 R010 DISP-ENR 9J51 9R51, CODE 3
 18:21:27 R010 ID 9J51 <1929>MICHAEL BERG
 18:21:27 R010 ID 9R51 <2651>MARK GRAMBLING
 18:21:53 R011 MISCX RP FROM APPT [REDACTED] HEARD 4 SHOTS AND HEARS A 415
 18:22:06 R010 MISC 9J51, 33
 18:22:17 CR02 MISCX FIRE & AMB ERT
 18:22:20 CR04 MISCX ONE SUBJ PINEED ONTO A TRUCK// RP [REDACTED]

18:22:40 CR04 MISCX RP ADV ONE SUBJ MIGHT BE AN UNDERCOVER OFC
 18:22:59 R010 BACK-ER 9J51 4E12, CODE 3
 18:22:59 R010 ID 4E12 <2507>ERIC HATLEE
 18:23:09 CR02 MISCX FIRE STAGING
 18:23:24 R010 DUP-OF 063180558 TO 063180557
 18:23:39 CR03 BACK-ER 9J51 9051
 18:23:39 CR03 ID 9051 <3597>CHRISTOPHER JONES (CIT)
 18:24:01 CT08 SUPP TEXT:RP DISCONNECTED
 18:24:13 CR04 MISCX [REDACTED] ADV 2 MALES ONE HAD A GUN AND ONE SUBJ
 DRAGGED OUT OF A CAB OF A WHI PICK UP/ [REDACTED]

18:24:27 CR02 ONSCENE 9J51
 18:24:34 CR04 MISCX RP ADV THE PLOT IS A BLK W OF CONEJO SCHOOL
 18:24:44 CR02 BACK-OS 9J51 9041
 18:24:44 CR02 ID 9041 <3045>PAUL FERRUZZA
 18:25:32 CR02 BACK-ER 9041 3CK
 18:25:32 CR02 ID 3CK <3424>BRIAN SLOMINSKI (CIT)
 18:25:38 CR02 CLEAR 3CK
 18:25:41 CR02 BACK-ER 9041 3CK
 18:25:41 CR02 ID 3CK <3424>BRIAN SLOMINSKI (CIT)
 18:25:45 CR02 BACK-OS 9041 9T3 9M6
 18:25:45 CR02 ID 9T3 <3421>LAURA NATOLI
 18:25:45 CR02 ID 9M6 <3472>KEITH HALL (AR15 CIT)
 18:26:08 CR02 MISC 9M6, NO OUTSTANDING SUBJS
 18:26:42 CR04 BACK-ER 9041 4S4
 18:26:42 CR04 ID 4S4 <2784>CARY PETERSON
 18:27:01 CR02 BACK-ER 9041 5T4
 18:27:01 CR02 ID 5T4 <2552>ERIC BUSCHOW
 18:27:15 CR02 BACK-ER 9041 9D21
 18:27:15 CR02 ID 9D21 <3273>ANTHONY TUTINO (CIT)
 18:27:30 CR02 BACK-ER 9041 9A21
 18:27:30 CR02 ID 9A21 <3384>PATRICK HAWTHORNE
 18:27:39 CR04 MISC .557, CORR: RP FROM LOS FELIX [REDACTED]
 18:28:44 R011 CASE S00600030492 Assigned
 18:28:46 CR02 DUP-OF 063180559 TO 063180557
 18:29:00 CR02 MISC 9041, FIRE ADV TO ENTER
 18:30:03 CR02 ADD-LIC 9T3 [REDACTED]

11/18/06

18:30:53 CR02 MISC [REDACTED]

18:30:58 CR02 ONSCENE 9051

18:31:10 CR02 ONSCENE 4E12

18:31:37 CR02 ONSCENE 5T4

18:33:51 R010 MISCX [REDACTED]

18:34:20 CR02 BACK-OS 9041 5T9

18:34:20 CR02 ID 5T9 <3713>MICHAEL HARRIS (CIT)

18:35:33 CR02 CHGLOCOS 9D21 53 N CONEJO SCHOOL RD ,TO

18:35:38 CR02 CHGLOCOS 9051 53 N CONEJO SCHOOL RD ,TO

18:35:56 CR02 ONSCENE 4S4

18:36:09 CR02 BACK-OS 9041 5S8

18:36:09 CR02 ID 5S8 <2886>LUIS ALVAREZ (BL)

18:36:17 CR02 BACK-OS 9041 9X1

18:36:17 CR02 ID 9X1 <2561>GUSTAVO MACIAS

18:36:27 CR02 ONSCENE 9A21

18:36:34 CR02 CHGLOCOS 9A21 53 N CONEJO SCHOOL RD ,TO

18:36:58 CR02 MISC 9051, SUBJ JUMPED INTO A WHITE BRONCO, TURNED LEFT ONTO THE BLVD

18:38:03 CR02 MISC 9051, EB TO BLVD

18:38:05 CR04 BACK-ER 9R51 9I51

18:38:05 CR04 ID 9I51 <3651>MARTA BUGARIN

18:39:14 R010 MISCX LASO ADVD

18:39:33 CR02 BACK-OS 9041 5S2

18:39:33 CR02 ID 5S2 <2569>JON SMITH

18:39:51 CR02 ONSCENE 9R51

18:40:06 CR02 BACK-OS 9041 5T

18:40:06 CR02 ID 5T <1276>JERRY WEAVER

18:41:13 CR02 ONSCENE 3CK

18:42:31 CR02 BACK-OS 9041 5S3

18:42:31 CR02 ID 5S3 <3056>JEFFREY MILLER

18:44:03 CR02 BACK-OS 9041 5H1

18:44:03 CR02 ID 5H1 <1365>MICHAEL POWERS

18:44:25 CR02 BACK-OS 9041 9H21

18:44:25 CR02 ID 9H21 <2657>JEFERY MANORY (CIT)

18:48:16 CR02 CHGLOC 9A21 215 W JANSS RD ,TO

18:49:36 CR02 BACK-ER 9041 3BK

18:49:36 CR02 ID 3BK <3065>SCOTT SEDGWICK

18:56:23 CR02 CHGLOC 3BK 53 N CONEJO SCHOOL RD ,TO

18:56:44 CR02 CLEAR 9H21

18:56:53 CR02 ONSCENE 9A21

18:57:05 SUP1 BACK-ER 4S4 5E2

18:57:05 SUP1 ID 5E2 <3322> [REDACTED]

18:57:13 CR02 BACK-ER 9041 5H21

18:57:13 CR02 ID 5H21 <2775>ROBERT DAVIDSON

18:57:19 SUP1 CHGLOCOS 5E2 BI OFFICE

18:57:31 CR02 BACK-ER 9041 5H7

18:57:31 CR02 ID 5H7 <1438>STEVEN RHODS

19:01:23 CR02 BACK-ER 9041 5S

19:01:23 CR02 ID 5S <2486>STEVEN SAGELY

19:01:58 CR02 ONSCENE 3BK

19:02:07 CR02 ONSCENE 9I51

19:08:41 CR04 CLEAR 9I51

19:09:22 CR04 CLEAR 9M6

19:10:08 CR02 ONSCENE 5H7

19:12:14 CR04 BACK-OS 9041 CAR12

19:12:14 CR04 ID CAR12 <0998>KEITH PARKS

19:12:19 CR02 CLEAR CAR12

19:12:23 CR02 BACK-OS 9041 CAR12

19:12:23 CR02 ID CAR12 <0998>KEITH PARKS

19:13:07 R010 CHGLOC 5E2 [REDACTED]

19:13:32 CR04 BACK-OS 9R51 9I51

19:13:32 CR04 ID 9I51 <3651>MARTA BUGARIN

19:13:42 CR04 CHGLOCOS 9I51 215 W JANSS RD ,TO

19:14:24 CR04 BACK-ER 9R51 9C21
 19:14:24 CR04 ID 9C21 <3755>DANIEL BLANCK
 19:15:11 CR02 ONSCENE 5S
 19:17:13 R010 CHGLOCOS 5S3 2101 E OLSEN RD ,TO
 19:17:26 CR03 BACK-ER .557 9B21
 19:17:26 CR03 ID 9B21 <3628>DAVID KADOSONO (CIT)
 19:22:08 CR02 BACK-OS 9O41 5H16
 19:22:08 CR02 ID 5H16 <3318>WILLIAM AYUB
 19:22:30 CR02 BACK-OS 9O41 11L
 19:22:30 CR02 ID 11L <2074>RONALD NELSON (CIT)
 19:24:56 R011 ONSCENE 9B21
 19:25:20 R011 BACK-OS 9B21 9B11
 19:25:20 R011 ID 9B11 <2883>STEVEN MAYO (CIT)
 19:26:54 R010 ONSCENE 5E2
 19:29:03 R011 BACK-OS 9A21 9X2
 19:29:03 R011 ID 9X2 <2261>DANIEL HAWES
 19:30:21 R011 BACK-OS 9D21 9G21
 19:47:19 R011 BACK-OS 5H16 5L
 19:47:19 R011 ID 5L <1822>LAWRENCE KELLEY
 19:48:24 R011 CLEAR 3BK
 19:48:53 R011 BACK-OS 9G21 9G11
 19:48:53 R011 ID 9G11 <3219>SHANNON COLLINS (CIT)
 19:49:16 CR02 MISCX



CHECK BEHING LOC, SHE HEARD NOISES IN THE AREA OF THE TREES A FEW AGO

19:49:30 R011 ONSCENE 9C21
 19:50:18 R011 MISC 9G21, WILL BE RESPONDING TO
 19:51:17 R011 BACK-OS 9G11 9C11
 19:51:17 R011 ID 9C11 <2623>JOHN STEELE
 19:51:44 R011 BACK-OS 5H16 5E
 19:51:44 R011 ID 5E <2485>ANTHONY SANDERS
 19:51:52 R011 ONSCENE 5H21
 19:55:19 R011 MISCX 1033 LIFTED
 19:58:18 R011 BACK-ER 5H16 9T
 19:58:18 R011 ID 9T <0459>RICHARD GODFREY
 19:58:32 R011 BACK-OS 5H16 9X6
 19:58:32 R011 ID 9X6 <3152>BRIAN BAKER (CIT)
 19:58:45 R011 BACK-OS 5H16 5S1
 19:58:45 R011 ID 5S1 <2172>ALLEN DEVERS
 20:03:01 CR05 BACK-ER CAR12 11I1
 20:03:01 CR05 ID 11I1 <1440>BRUCE MACEDO
 20:05:24 R011 ONSCENE 9T
 20:09:05 R011 BACK-ER 9T 91R
 20:09:05 R011 ID 91R <2740>KELVIN RAUTIOLA
 20:16:50 R011 ONSCENE 91R
 20:21:57 R011 BACK-OS 5E 5E1 5E5
 20:21:57 R011 ID 5E1 <3426>
 20:21:57 R011 ID 5E5 <2963>
 20:45:07 R011 CLEAR 9I51
 20:45:31 R011 CLEAR 3CK
 20:51:35 CR03 MISC 5T9,
 20:51:48 CR03 MISC 5T9,
 20:56:50 R011 CLEAR 9X2
 21:03:26 R011 BACK-ER 5H16 CMPST
 21:03:52 R011 CHGLOCOS 5H1
 21:04:04 R011 CHGLOCOS 5E1
 21:04:09 R011 CHGLOCOS 5E5
 21:04:21 R011 CHGLOCOS 5H16
 21:04:28 R011 CHGLOCOS 5H21
 21:04:37 R011 CHGLOCOS 5H7
 21:04:45 R011 CHGLOCOS 5S1
 21:04:50 R011 CHGLOCOS 5S2
 21:04:56 R011 CHGLOCOS 5S3
 21:05:07 R011 CHGLOCOS 5S8
 21:06:47 R010 CLEAR 9C11
 21:14:03 R011 CHGLOCOS 9O41 75-BLK N CONEJO SCHOOL RD ,TO
 21:14:07 R011 CHGLOCOS 9O41 75-BLK N CONEJO SCHOOL RD ,TO
 21:14:12 R011 CHGLOCOS 9O51 75-BLK N CONEJO SCHOOL RD ,TO

21:14:48 R011 ONSCENE CMPST
21:35:22 R011 CHGLOCOS 5E5 215 W JANSS RD ,TO
21:35:27 R011 CHGLOCOS 5E1 215 W JANSS RD ,TO
21:38:33 R010 CHGLOCOS 5S8 2222 LOS FELIZ DR #215 ,TO
21:43:04 R011 CLEAR 9X1
21:43:10 R011 CLEAR 9X6
21:45:30 CT08 MISC .557, RELATED INCIDENT REPORT BY JONES RB 06-30499
21:48:15 R011 CLEAR 5T4
21:49:38 R011 CLEAR 9G21
21:55:33 R011 CLEAR 9C21
22:04:28 R011 ONSCENE 11I1
22:05:33 R011 RCONTACT 11L
22:05:36 R011 RCONTACT 4E12
22:05:38 R011 RCONTACT 4S4
22:05:41 R011 RCONTACT 5E
22:05:43 R011 RCONTACT 5E1
22:05:47 R011 RCONTACT 5E2
22:06:13 R011 RCONTACT 5H1
22:06:17 R011 RCONTACT 5H16
22:06:21 R011 RCONTACT 5H21
22:06:24 R011 RCONTACT 5H7
22:06:29 R011 RCONTACT 5E5
22:06:34 R011 RCONTACT 5L
22:06:37 R011 RCONTACT 5S
22:06:41 R011 RCONTACT 5S1
22:06:44 R011 RCONTACT 5S2
22:06:50 R011 RCONTACT 5S3
22:06:54 R011 RCONTACT 5T
22:06:57 R011 RCONTACT 91R
22:07:01 R011 RCONTACT 9A21
22:07:03 R011 RCONTACT 9B21
22:07:06 R011 RCONTACT 9D21
22:07:10 R011 RCONTACT 9B11
22:07:18 R011 RCONTACT 9G11
22:07:22 R011 RCONTACT 9J51
22:07:25 R011 RCONTACT 9O41
22:07:34 R011 RCONTACT 9O51
22:07:38 R011 RCONTACT 9R51
22:07:43 R011 RCONTACT 9T
22:07:47 R011 RCONTACT 9T3
22:07:52 R011 RCONTACT CAR12
22:07:55 R011 RCONTACT CMPST
22:10:06 R011 CLEAR 9O41
22:22:54 R010 CLEAR 9A21
22:23:23 R010 CLEAR 5T9
22:25:37 R010 CLEAR 5S2
22:25:59 R010 CLEAR 9O51
22:30:42 CR03 QUERY 9G11
22:57:41 CR03 RCONTACT 5S8
23:19:20 R010 CLEAR 5H7
23:44:11 R010 CLEAR 9J51
23:51:18 R010 CLEAR 9B11
23:55:18 R010 CLEAR 91R
23:56:02 R010 CLEAR 9T
23:56:31 R010 CLEAR 4E12
23:57:29 R010 CLEAR 5S3

11/15/06
00:19:07 R010 CLEAR 5T
00:24:01 R010 CLEAR 9R51
00:58:37 R011 MISC 5H16
00:58:47 R011 ADD-LIC 5H16
01:24:43 CR03 PREEMPT 9T3
01:31:21 CR03 BACK-OS 9D21 9O51
01:31:21 CR03 ID 9O51 <3597>CHRISTOPHER JONES (CIT)
01:31:47 CR03 CHGLOCOS 9O51
01:46:00 CR03 RCONTACT 11I1
01:48:31 CR03 CHGLOC CMPST
01:48:59 CR03 CLEAR 9G11 RPT

01:55:36 CR03 CLEAR 5H16
01:58:48 CR03 CLEAR 5E2
01:58:51 CR03 CLEAR 4S4
01:59:03 CR03 CLEAR CMPST
02:00:32 CR03 CLEAR 9D21
02:04:15 CR03 CLEAR 5E
02:07:19 CR03 PREEMPT 9051
02:08:03 CR03 CLEAR CAR12
02:08:04 CR05 MISC .557, CANLEY ADRIAN [REDACTED]
02:09:50 CR03 DUP-OF 063180540 TO 063180557
02:09:58 CR03 BACK-OS .557 5T3
02:09:58 CR03 ID 5T3 <3127>SHANE MATTHEWS
02:10:06 CR03 CLEAR 5T3
02:10:21 CR05 MISC .557, SUBJ WAS REPORTED AS A MISSING SUICIDAL FROM STA
4
02:10:33 CR05 MISC .557, STA 4 REPORT #
02:12:48 CR05 MISC .557, STA 4 REPORT #06-0038
02:14:06 CR03 CLEAR 9B21
02:37:34 CR03 CLEAR 11I1
02:37:35 CR03 CLEAR 11L
02:37:37 CR03 CLEAR 5E1
02:37:38 CR03 CLEAR 5E5
02:37:40 CR03 CLEAR 5H1
02:37:42 CR03 CLEAR 5H21
02:37:44 CR03 CLEAR 5L
02:37:45 CR03 CLEAR 5S
02:37:46 CR03 CLEAR 5S1
02:37:48 CR03 CLEAR 5S8
02:37:48 CR03 CLOSE 5S8

OPERATOR ASSIGNMENTS: R011 2885
R010 4134
CR02 2540
CR04 4156
CR03 4075
CT08 2508
SUP1 4225
AS OF 19:17:13: R010 2829
AS OF 19:17:26: CR03 4312
AS OF 19:29:03: R011 1196
CR05 4513



INCIDENT HISTORY DETAIL: S063180558

INITIATE: 18:20:59 11/14/06 CALL NUMBER: S0558
 ENTRY: 18:21:27 CURRENT STATUS: CANCELLED
 DISPATCH: PRIMARY UNIT:
 ONSCENE: JURISDICTION: SO
 CLOSE: 18:23:24 DISPOSITION: DUP

LOCATION COMMENTS:

DAREA: EAST
 BEAT: 9G01 MAP PAGE: 556-J1 TYPE: SHOTS SHOTS FIRED
 RD: 9072 PRIORITY: E (IN-PROGRESS)
 PRIORS

18:21:27 CT08 ENTRY TEXT:SHOTS FIRE SUBJECT DOWN//CODE 3
 18:21:27 CT08 PRIOR SP T 06/22/06 @ 17:05:14 (5 MORE)
 18:21:50 CT08 SUPP TEXT:DEP MATTHEWS ON SCENE //SUSPECT DOWN
 18:22:25 CT08 UPDATE
 18:22:25 CT08 SUPP

18:23:24 R010 DUP-TO 063180558 TO 063180557

OPERATOR ASSIGNMENTS: CT08 2508
 R010 4134